



INSTALLATION, OPERATION, AND MAINTENANCE MANUAL  
WELKER® SAMPLE CONDITIONING HEATED SYSTEM

**MODEL**

SCHS

**DRAWING NUMBERS**

AD822BU

AD822BZ

**MANUAL NUMBER**

IOM-132

**REVISION**

Rev. C, 4/20/2016

## TABLE OF CONTENTS

	<b>SAFETY</b>	<b>3</b>
<b>1.</b>	<b>PRODUCT INFORMATION</b>	<b>4</b>
1.1	Introduction	4
1.2	Product Description	4
1.3	Specifications	5
1.4	Equipment Diagrams	6
<b>2.</b>	<b>INSTALLATION &amp; OPERATION</b>	<b>10</b>
2.1	Before You Begin	10
2.2	Installation and Operation	10
<b>3.</b>	<b>MAINTENANCE</b>	<b>14</b>
3.1	Before You Begin	14
3.2	Maintenance	15
3.3	Heater Failure	22
	<b>APPENDICES</b>	<b>25</b>
	A: Referenced or Attached Documents	25
	B: Preparing the SCHS for Installation in Locations With Limited Clearance	26

Welker®, Welker Jet®, WelkerScope®, and OdorEyes® are Registered Trademarks owned by Welker, Inc.

# IMPORTANT SAFETY INFORMATION

## READ ALL INSTRUCTIONS



Notes emphasize information and/or provide additional information to assist the user.



Caution messages appear before procedures that could result in damage to equipment if not observed.



Warning messages appear before procedures that could result in personal injury if not observed.

*This manual is intended to be used as a basic installation and operation guide for the Welker® Sample Conditioning Heated System, SCHS. For comprehensive instructions, please refer to the IOM Manuals for each individual component. A list of relevant component IOM Manuals is provided in Appendix A of this manual.*

*The information in this manual has been carefully checked for accuracy and is intended to be used as a guide for the installation, operation, and maintenance of the Welker® equipment described in this manual. Correct installation and operation, however, are the responsibility of the end user. Welker reserves the right to make changes to this manual and all products in order to improve performance and reliability.*

### BEFORE YOU BEGIN

Read these instructions completely and carefully.

**IMPORTANT** - Save these instructions for local inspector's use.

**IMPORTANT** - Observe all governing codes and ordinances.

**Note to Installer** - Leave these instructions with the end user.

**Note to End User** - Keep these instructions for future reference.

Installation of this Sample Conditioning Heated System is of a mechanical and electrical nature.

Proper installation is the responsibility of the installer. Product failure due to improper installation is not covered under the warranty.

If you received a damaged Sample Conditioning Heated System, please contact a Welker® representative immediately.

**Phone:** 281.491.2331

**Address:** 13839 West Bellfort Street  
Sugar Land, TX 77498

### 1.1 Introduction

We appreciate your business and your choice of Welker® products. The installation, operation, and maintenance liability for this equipment becomes that of the purchaser at the time of receipt. Reading the applicable *Installation, Operation, and Maintenance (IOM) Manuals* prior to installation and operation of this equipment is required for a full understanding of its application and performance prior to use.\*

If you have any questions, please call Welker at 1-281-491-2331.

*\*The following procedures have been written for use with standard Welker® parts and equipment. Assemblies that have been modified may have additional requirements and specifications that are not listed in this manual.*

### 1.2 Product Description

The Welker® *SCHS* Sample Conditioning Heated System is designed to prepare gas samples for a downstream analyzer by removing free liquids and then heating and regulating the sample stream.

Pipeline product enters the system through the Welker® LE-2SSKO Probe Mounted Liquid Eliminator. The gas stream passes through the LE-2SSKO to the Welker® HR-4SS Heated Instrument Regulator, whereas liquids are separated from the sample stream by centripetal force, a filter element, and a screen. Gravity then returns the separated liquids to the pipeline through the stinger.

The HR-4SS heats the gas prior to decreasing the pressure to compensate for the cooling brought on by the Joule-Thomson effect and prevent changes in gas composition. A thermostat is included to allow the operator to set the temperature. The optional temperature transmitter can be connected to the customer Programmable Logic Controller (PLC) for remote monitoring of the temperature of the heated gas.

After being conditioned by the LE-2SSKO and HR-4SS, the gas must pass through the Welker® ALS-1 Analyzer Liquid Shutoff, the system's final line of analyzer defense. Gas flows freely through the ALS-1, but if liquid is present, the internal floating ball will seal, shutting off product flow to the analyzer.



For this manual, the term "PLC," or Programmable Logic Controller, will be used to refer to the PLC, DCS, or other signal control system used by the customer to activate and operate the solenoid.

*Welker may custom design the SCHS to suit the particular application and specifications of each customer.*

## 1.3 Specifications



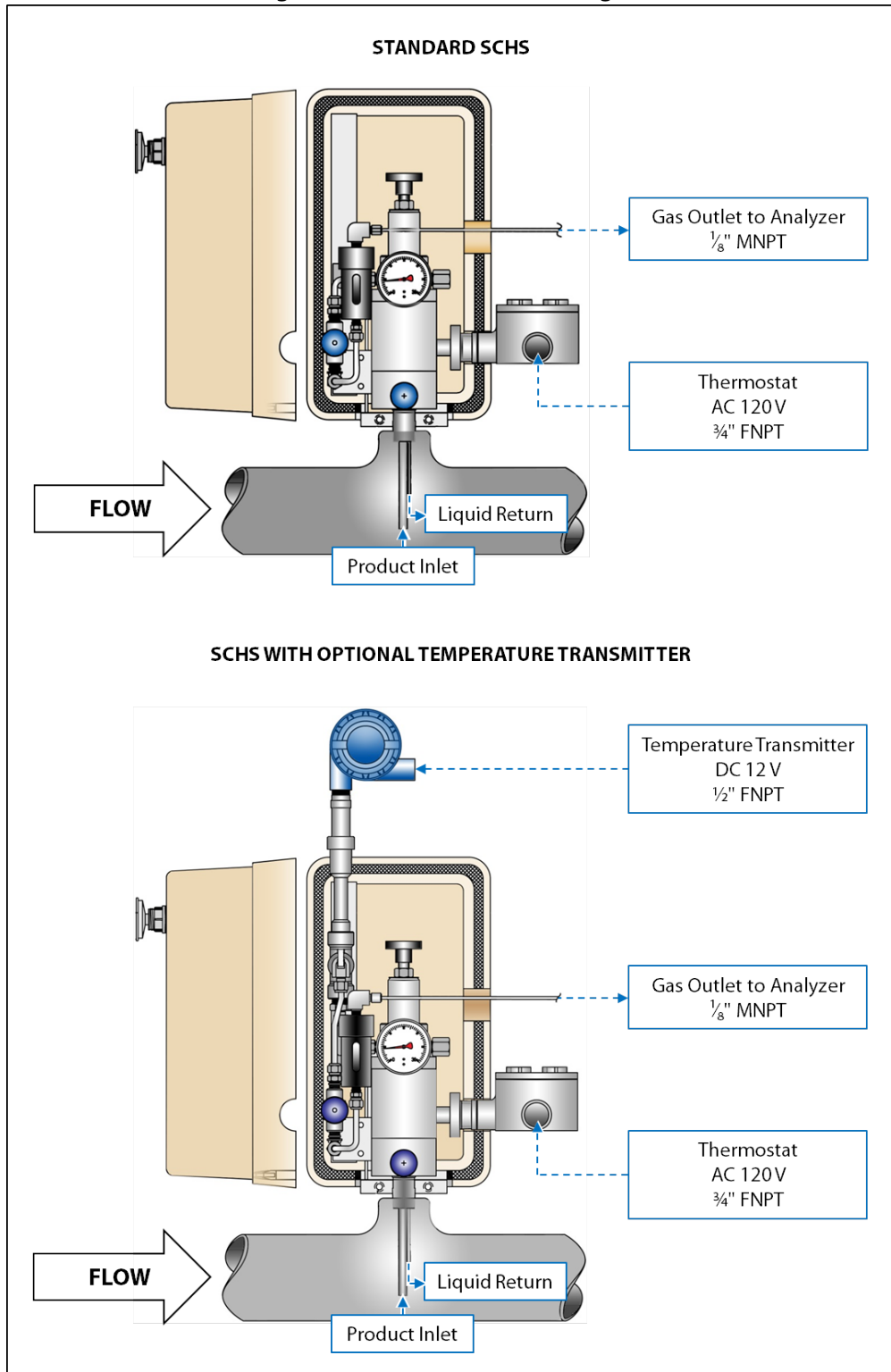
The specifications listed in this section are generalized for this equipment. Welker can modify the equipment according to your company's needs. **Please note that the specifications may vary depending on the customizations of your equipment.**

**Table 1: SCHS Specifications**

<b>Products</b>	Gases Compatible With the Materials of Construction
<b>Materials of Construction</b>	304 Stainless Steel, 316/316L Stainless Steel, Aluminum, Glass (ALS-1), PTFE, Teflon®, and Viton® Others Available
<b>Maximum Allowable Operating Pressure</b>	2160 psig @ -20 °F to 100 °F (148 barg @ -28 °C to 37 °C) Others Available
<b>Temperature Range</b>	68 °F to 212 °F (20 °C to 100 °C)
<b>Outlet Connection</b>	1/8" MNPT
<b>Pipeline Connection</b>	1/2" MNPT 3/4" MNPT (Standard) 1" MNPT Others Available
<b>Output Range</b>	0–25 psig (0–1.7 barg) 0–50 psig (0–3.4 barg) 20–100 psig (1.3–6.8 barg)
<b>Insertion Length</b>	1 1/2" (3.8 cm) 8" (20.3 cm) (Standard) 31" (78.7 cm)
<b>Electrical Connections</b>	<b>Temperature Transmitter (Optional):</b> DC 12 V, 1/2" FNPT <b>Thermostat:</b> AC 120 V, 3/4" FNPT
<b>Filtration</b>	Nominal 25 Micron Internodal Distance
<b>Features</b>	Insulated Enclosure Pre-Set Relief Pressure Gauge and Relief Welker® ALS-1 Analyzer Liquid Shutoff Welker® HR-4SS Heated Instrument Regulator Welker® LE-2SSKO Probe Mounted Liquid Eliminator
<b>Industry Standards</b>	API 14.1 GPA 2166
<b>Patents</b>	U.S. Patent 6,764,536 and 7,471,882
<b>Option</b>	Temperature Transmitter Assembly

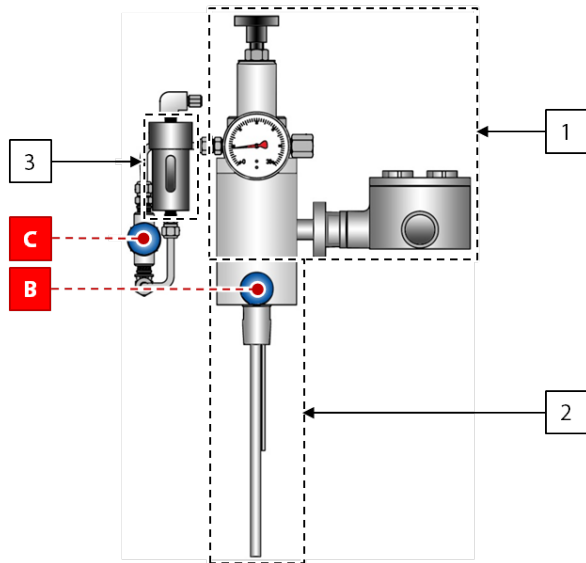
## 1.4 Equipment Diagrams

Figure 1: SCHS Connections Diagram

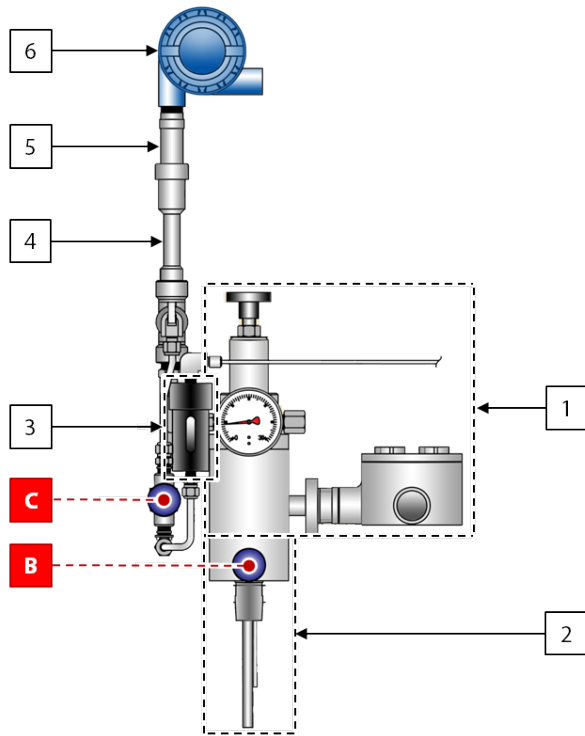


**Figure 2: SCHS Diagram**

**STANDARD SCHS**

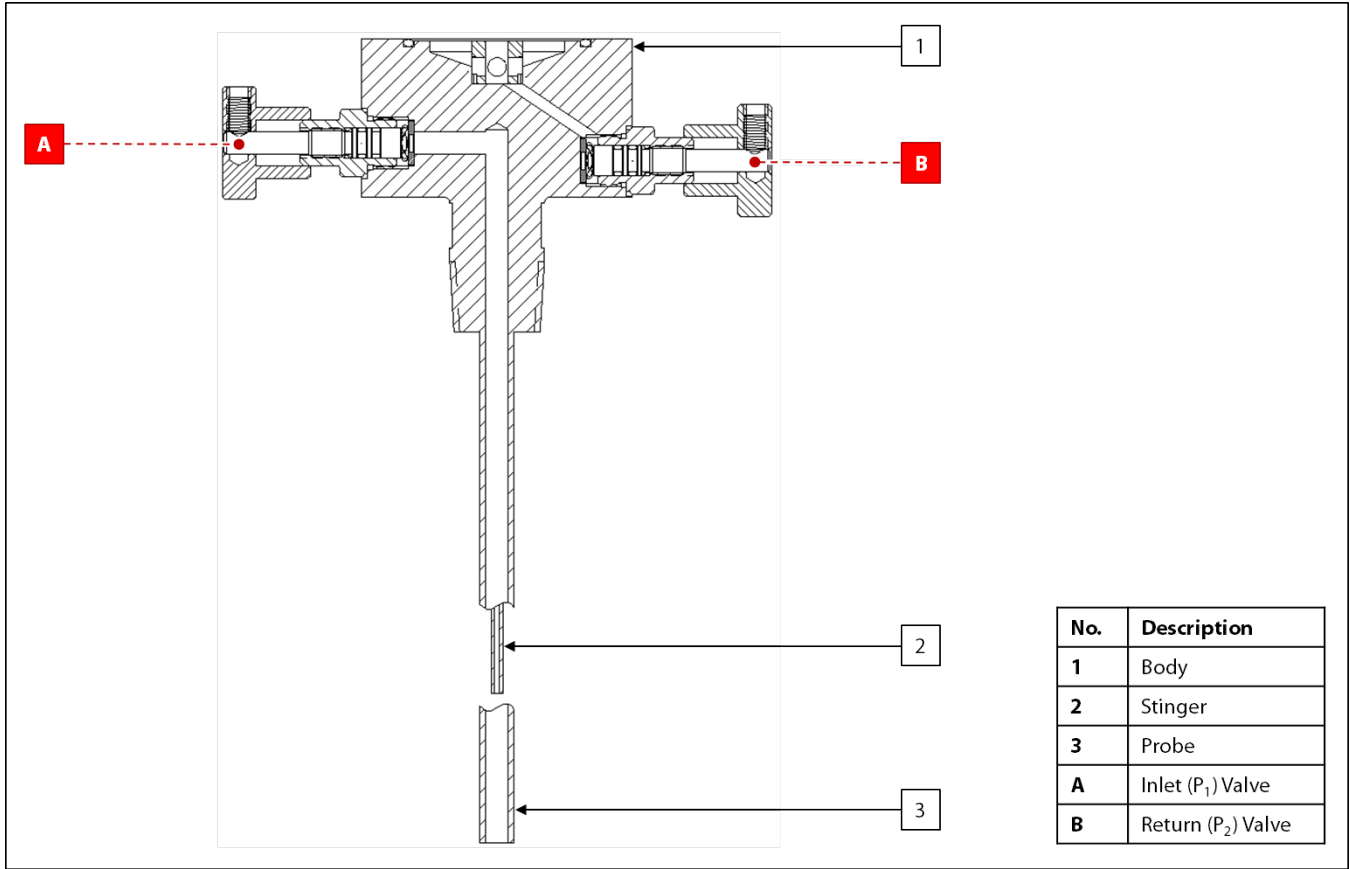


**SCHS WITH OPTIONAL TEMPERATURE TRANSMITTER**

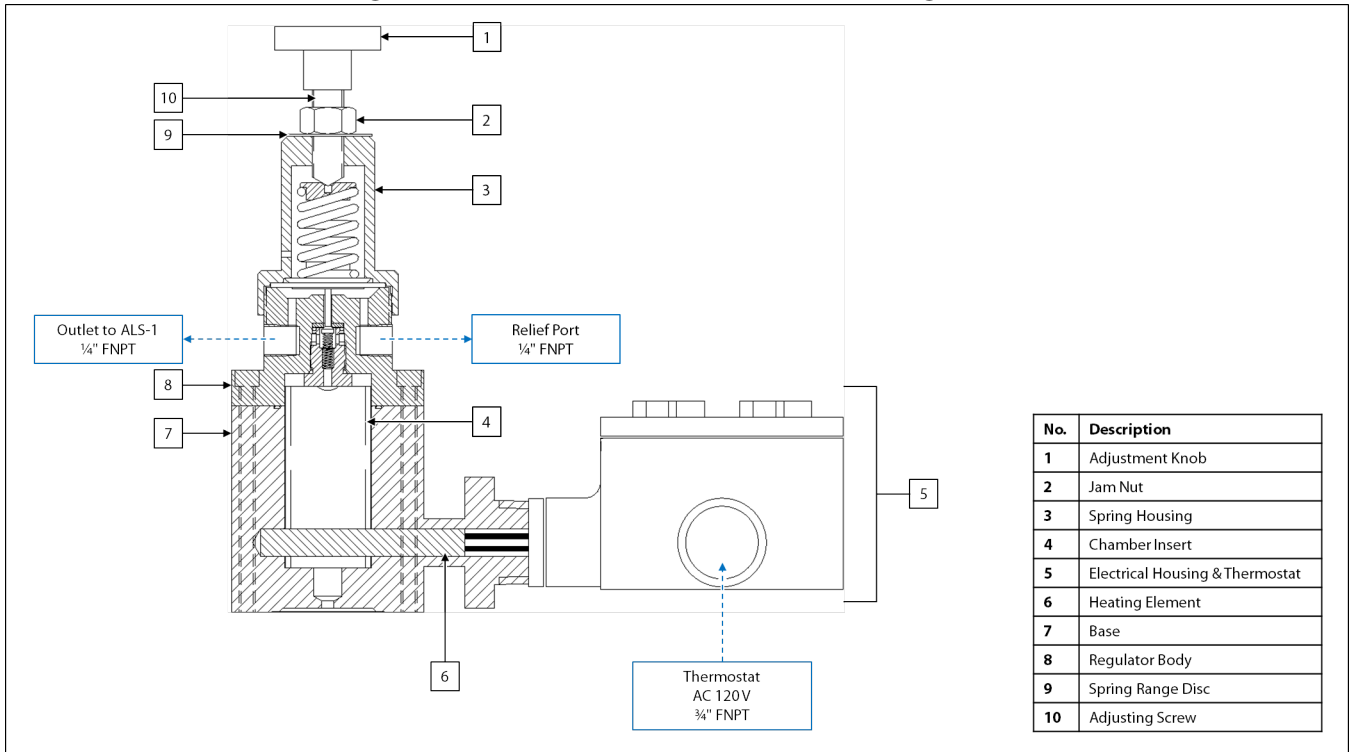


No.	Description
1	Welker® HR-4SS Heated Instrument Regulator (See Figure 4)
2	Welker® LE-2SSKO Probe Mounted Liquid Eliminator (See Figure 3)
3	Welker® ALS-1 Analyzer Liquid Shutoff (See Figure 5)
4	Thermowell (Optional)
5	Temperature Sensor (Optional)
6	Temperature Transmitter (Optional)
A	Inlet (P <sub>1</sub> ) Valve (Not Shown)
B	Return (P <sub>2</sub> ) Valve
C	ALS Isolation Valve
<b><i>Shown Without Enclosure for Clarity</i></b>	

**Figure 3: Welker® LE-2SSKO Probe Mounted Liquid Eliminator**

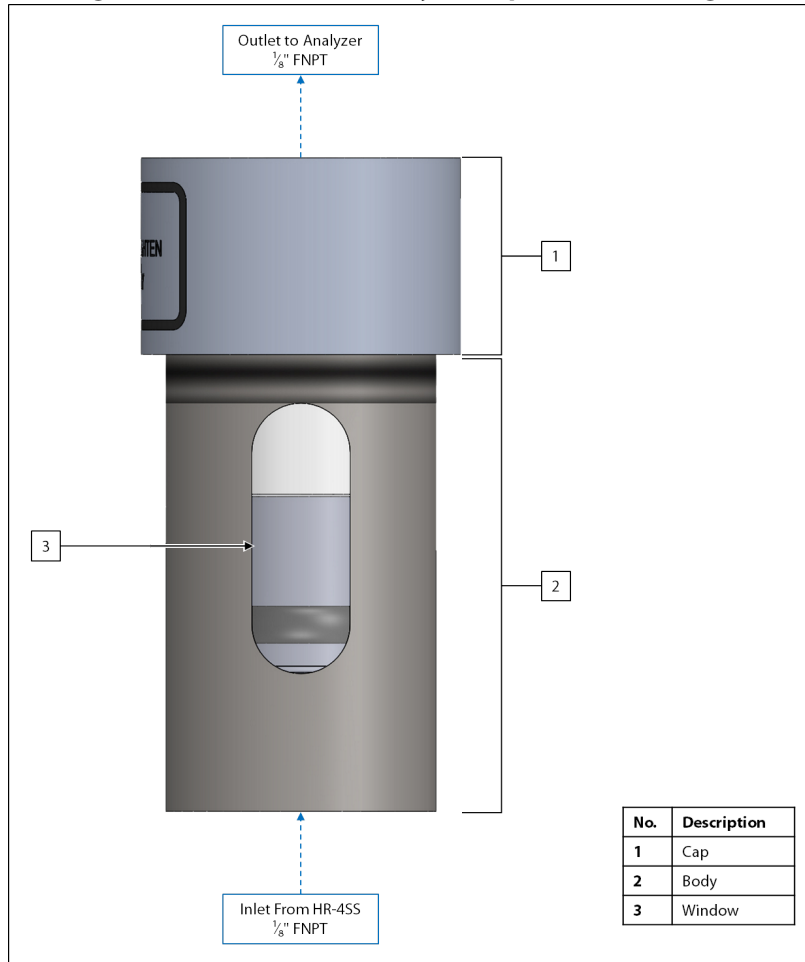


**Figure 4: Welker® HR-4SS Heated Instrument Regulator**





**Figure 5: Welker® ALS-1 Analyzer Liquid Shutoff Diagram**



## SECTION 2: INSTALLATION & OPERATION

### 2.1 Before You Begin



After unpacking the unit, check the equipment for compliance and any damage that may have occurred during shipment. Immediately contact a Welker® representative if you received damaged equipment.

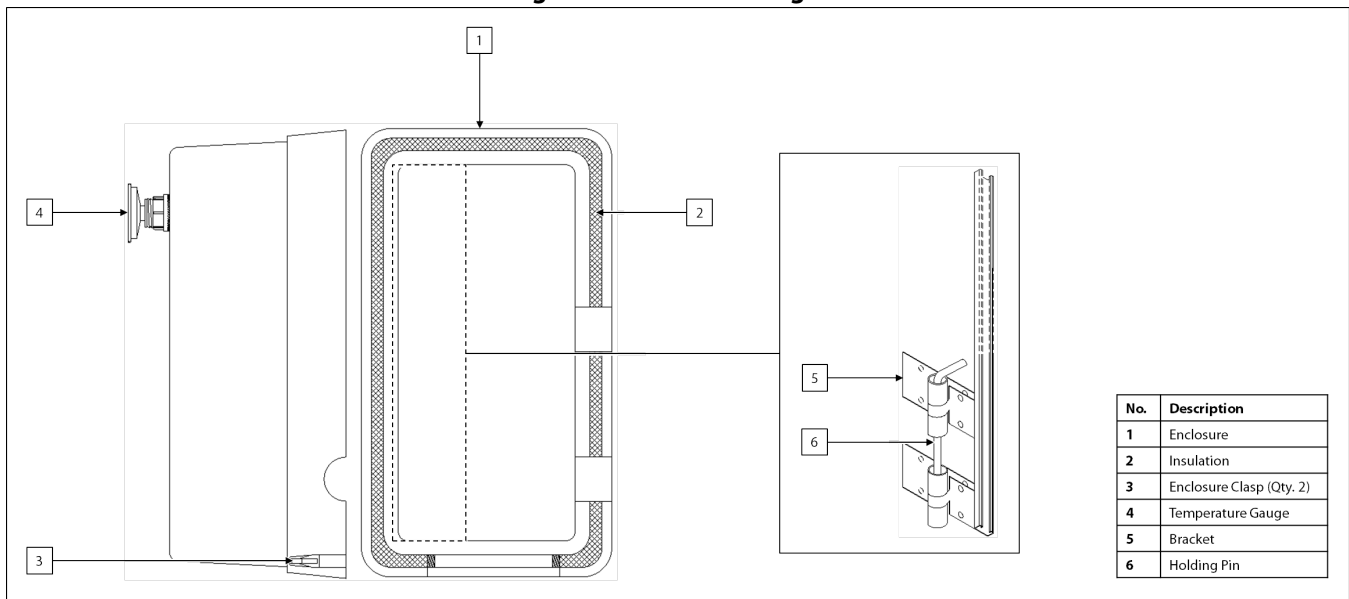


When sealing fittings with PTFE tape, refer to the proper sealing instructions for the brand used.

### 2.2 Installation and Operation

#### Removing the Enclosure

**Figure 6: Enclosure Diagram**



1. Undo the enclosure clasps and open the enclosure (*Figure 6*).
2. Remove the holding pin from the bracket (*Figure 6*). Set the holding pin aside and take care not to misplace the holding pin.
3. Carefully remove the enclosure from the SCHS.

## **Preparing for Installation**

4. Determine the desired length of the probe. As necessary, cut the probe and stinger to the desired length (*Figure 3*).



Ensure that no shavings or metal pieces remain in the probe after clipping or trimming to size.



Welker recommends that the probe be installed in the top of the pipe and inserted into the center one-third ( $\frac{1}{3}$ ) of the pipeline in a location where the product is well-mixed and will yield an accurate and representative sample. The sample probe should be located in the least turbulent area of the flowing stream available (i.e., not in a header or blow-down stack and away from obstructions, elbows, and partially closed valves).

5. If the SCHS must be installed in a location with limited clearance for customer connections, refer to *Appendix B, Preparing the SCHS for Installation in Locations With Limited Clearance*, for instructions on preparing the SCHS for installation.

## **Installing the SCHS**

6. Depressurize the pipeline.



The pipeline must be depressurized prior to installing and removing the unit.

7. Ensure that all valves on the SCHS are closed (*Figure 2*).
8. As necessary, wrap the threads of the threaded pipeline connection with PTFE tape.
9. Install the SCHS to the pipeline so that the stinger of the LE-2SSKO is downstream of the direction of product flow (*Figure 1* and *Figure 3*).
10. In a counterclockwise direction, back off the adjusting screw of the Welker® HR-4SS (*Figure 4*) so that the unit is closed (i.e., no setting or tension on the spring).
11. Pressurize the pipeline. Check for leaks and repair as necessary.

## **Installing the Enclosure**

12. Fit the open enclosure around the installed SCHS.
13. Secure the enclosure to the SCHS by inserting the holding pin into the bracket (*Figure 6*).

## System Connections

14. Using customer-supplied  $\frac{1}{8}$ " tubing, connect from the gas outlet to the analyzer inlet (*Figure 1*).



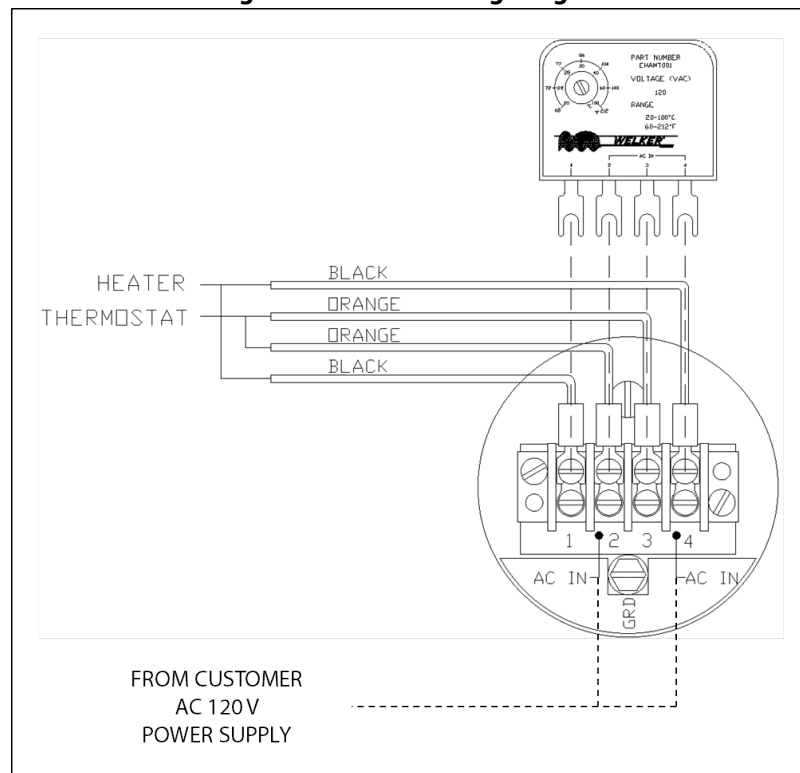
Welker recommends that this tubing be insulated and heat-traced so that the sample maintains its temperature increase prior to reaching the analyzer.

15. With the customer-supplied electrical power turned OFF, connect the AC 120 V leads to terminals 2 and 4 in the provided electrical housing (*Figure 7*).



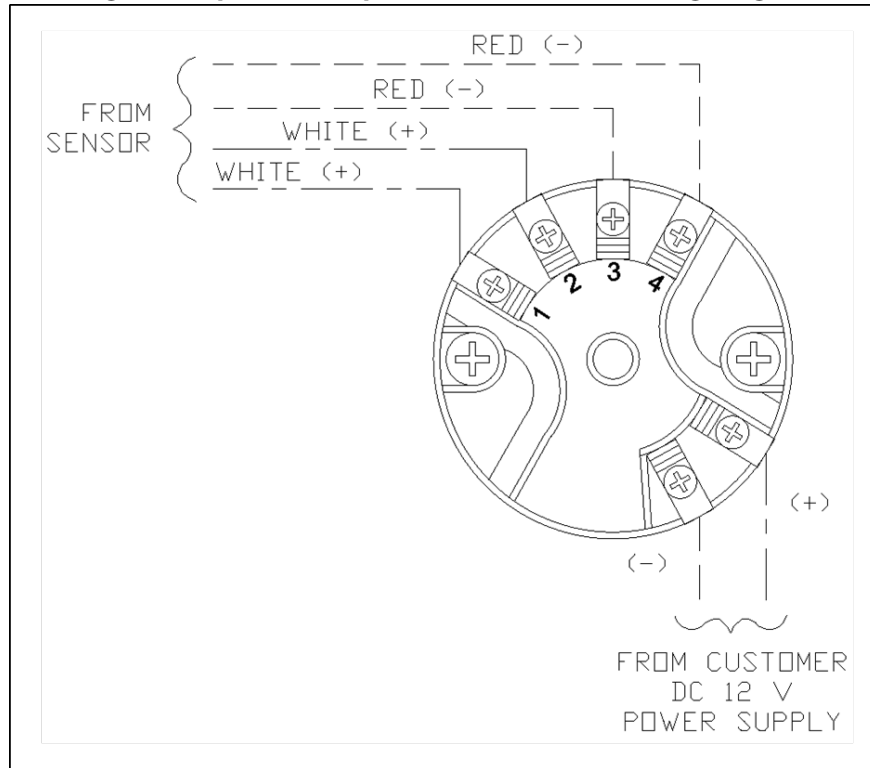
If wired incorrectly, the thermostat will be damaged and will need to be replaced.

**Figure 7: HR-4SS Wiring Diagram**



16. If the SCHS is equipped with the optional temperature transmitter assembly, connect a DC 12 V power supply to the temperature transmitter (*Figure 8*).

**Figure 8: Optional Temperature Transmitter Wiring Diagram**



### **Start-Up Procedures**

17. Turn ON the electrical power to begin operation.
18. Adjust the thermostat to the desired temperature. Allow at least thirty (30) minutes for the HR-4SS to warm up.
19. Loosen the jam nut on the adjusting screw (*Figure 4*).
20. Open inlet ( $P_1$ ) valve A and return ( $P_2$ ) valve B (*Figure 2*).
21. Screw the adjustment knob clockwise to adjust the outlet pressure (*Figure 4*). Tighten the jam nut once the desired outlet pressure has been set.
22. Set the relief valve. Refer to the *Installation, Operation, and Maintenance (IOM) Manual* for the relief valve for instructions on setting the relief.
23. Slowly open ALS isolation valve C (*Figure 2*).
24. Set the analyzer and purge the line to the analyzer in accordance with company policy.
25. Close the enclosure lid and secure it using the enclosure clasps (*Figure 6*).
26. Monitor the temperature on the temperature gauge on the enclosure exterior (*Figure 6*). If the SCHS is equipped with the optional temperature transmitter assembly, the temperature can be monitored remotely from the PLC. Once the desired temperature has been reached, the SCHS is operational.

### 3.1 Before You Begin

1. **Welker recommends that the unit have standard maintenance every six (6) months under normal operating conditions.** In cases of severe service, dirty conditions, excessive usage, or other unique applications that may lead to excess wear on the unit, a more frequent maintenance schedule may be appropriate.
2. Prior to maintenance or disassembly of the unit, it is advisable to have a repair kit available for repairs of the system in case of unexpected wear or faulty seals.



New seals supplied in spare parts kits should be lightly lubricated before being installed to ease the installation of the seals and reduce the risk of damage when positioning them on parts. Wipe excess lubricant from the seals, as it may adversely affect analytical instrument results.



For sample-exposed seals, Welker recommends non-hydrocarbon-based lubricants, such as Krytox®. For non-sample-exposed seals, Welker recommends either non-hydrocarbon-based lubricants or silicone-based lubricants, such as Molykote® 111.



After the seals are installed, the outer diameter of shafts and inner diameter of cylinders may be lubricated to allow smooth transition of parts.

3. All maintenance and cleaning of the unit should be performed on a smooth, clean surface.
4. Welker recommends having the following tools available for maintenance. Please note that the exact tools required may vary by model.
  - a. 6" Adjustable Wrench
  - b. Multimeter
  - c. Seal Pick
  - d. Small Hex Key

### 3.2 Maintenance

1. Turn OFF all electrical power to the unit.



The heated regulator will be HOT after use. Allow approximately thirty (30) minutes for the regulator to cool down prior to performing maintenance.

2. Undo the enclosure clasps and open the enclosure lid (Figure 6).
3. Remove the holding pin from the bracket (Figure 6). Set the holding pin aside and take care not to misplace the holding pin.
4. Carefully remove the enclosure from the SCHS.
5. Close inlet ( $P_1$ ) valve A, return ( $P_2$ ) valve B, and ALS isolation valve C (Figure 2).



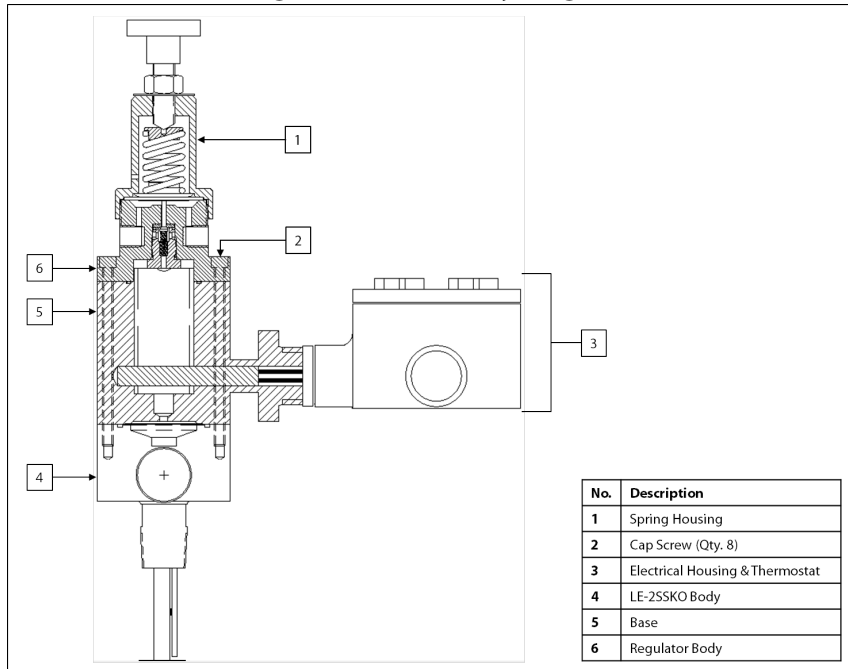
Prior to performing maintenance, the LE-2SSKO must be isolated from pipeline pressure. However, the LE-2SSKO does NOT need to be removed from the pipeline to perform standard maintenance.

6. Disconnect the electrical wiring and all tubing from the SCHS.

#### Disassembly

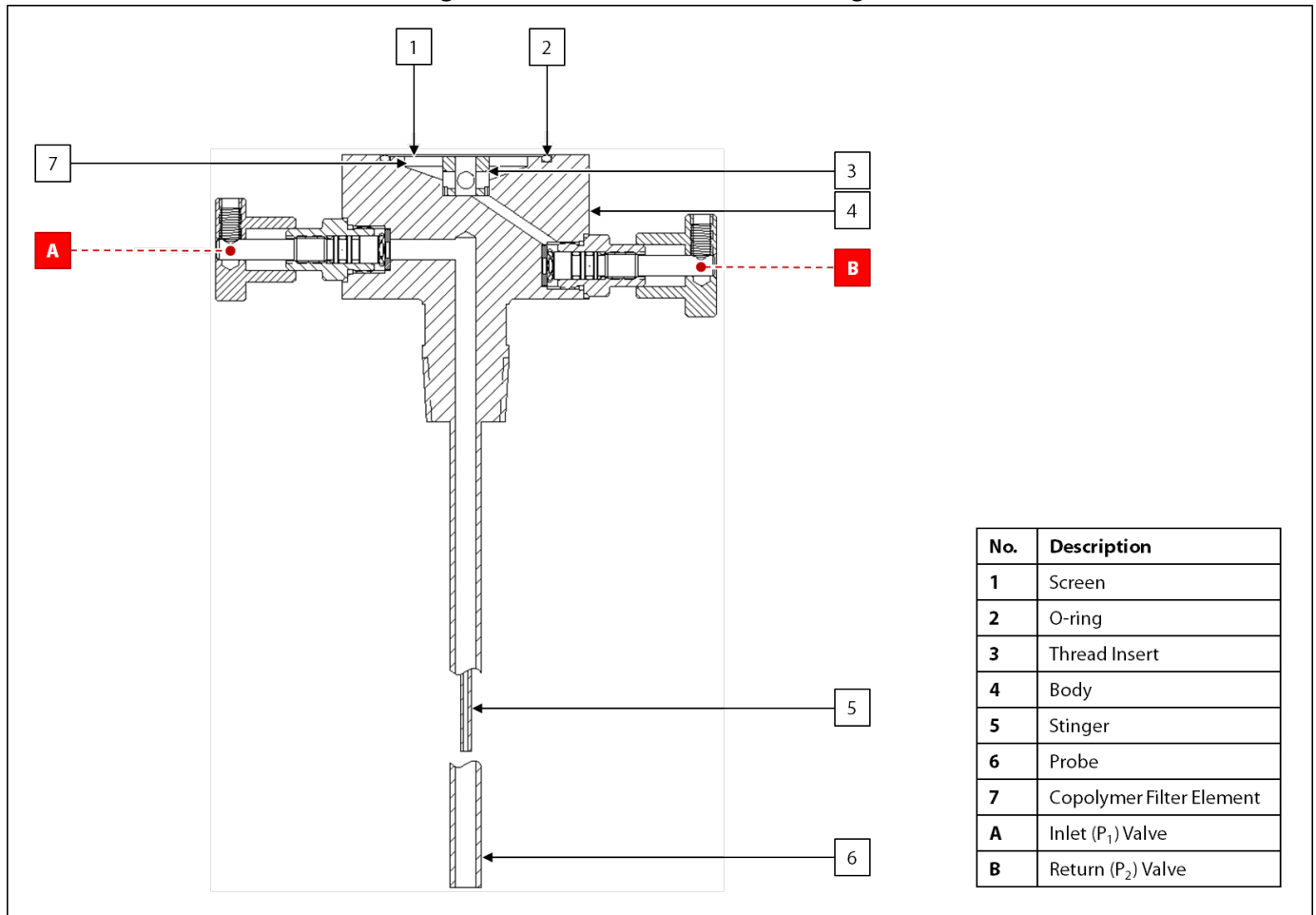
7. Loosen the eight (8) cap screws in the regulator body, and then separate the HR-4SS from the LE-2SSKO (Figure 9). Set the HR-4SS aside.

**Figure 9: Disassembly Diagram**



8. Unscrew the ALS-1 from ALS isolation valve C (Figure 2).

Figure 10: LE-2SSKO Maintenance Diagram



9. Remove the screen.
10. Remove the O-ring.
11. Remove the copolymer filter element.
12. Verify the return is clear. Hold a clean rag over the opening in the body, and then open inlet (P<sub>1</sub>) valve A and return (P<sub>2</sub>) valve B. If the return is clear, the rag will remain clean. If opening the valves cleared the return, the rag will be dirty. After verifying the return is clear, close inlet (P<sub>1</sub>) valve A and return (P<sub>2</sub>) valve B.
13. Using a solvent, clean the screen and inside of the body.



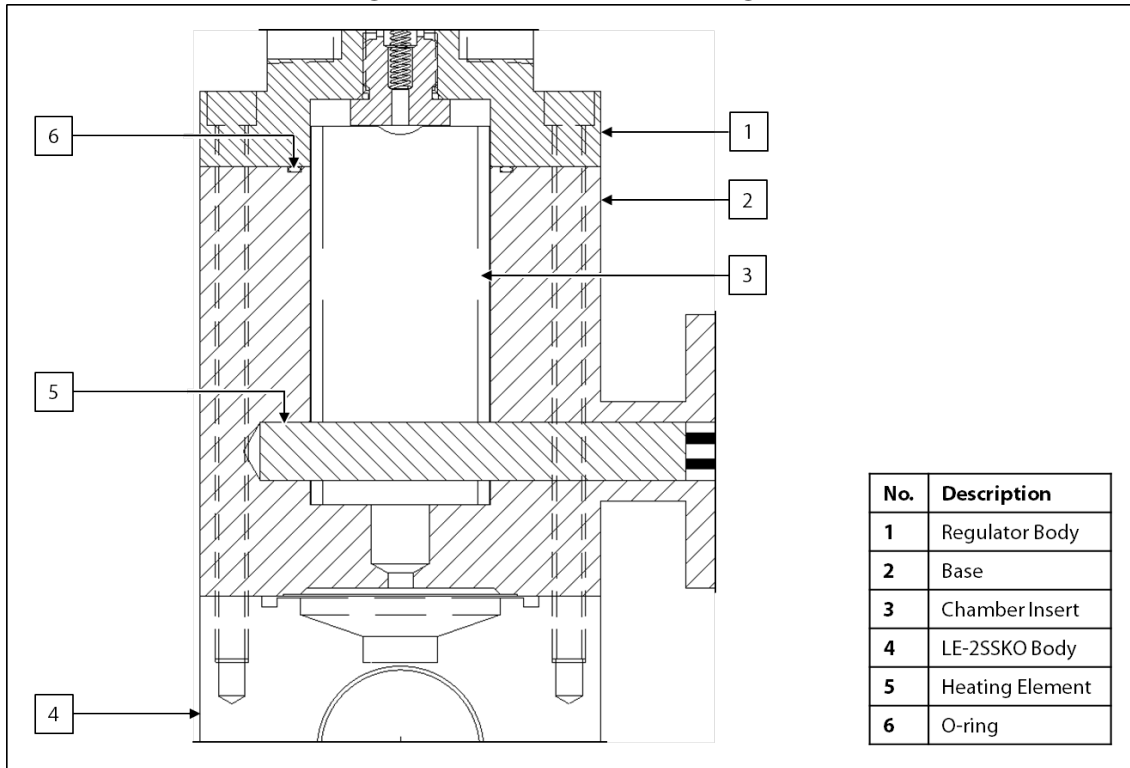
Welker recommends using a solvent, such as rubbing alcohol, that does not leave a film when dry and will not adversely affect analytical instrument results.

14. Replace the copolymer filter element.
15. Replace the O-ring.
16. Return the cleaned screen to the top of the copolymer filter element.



**Base**

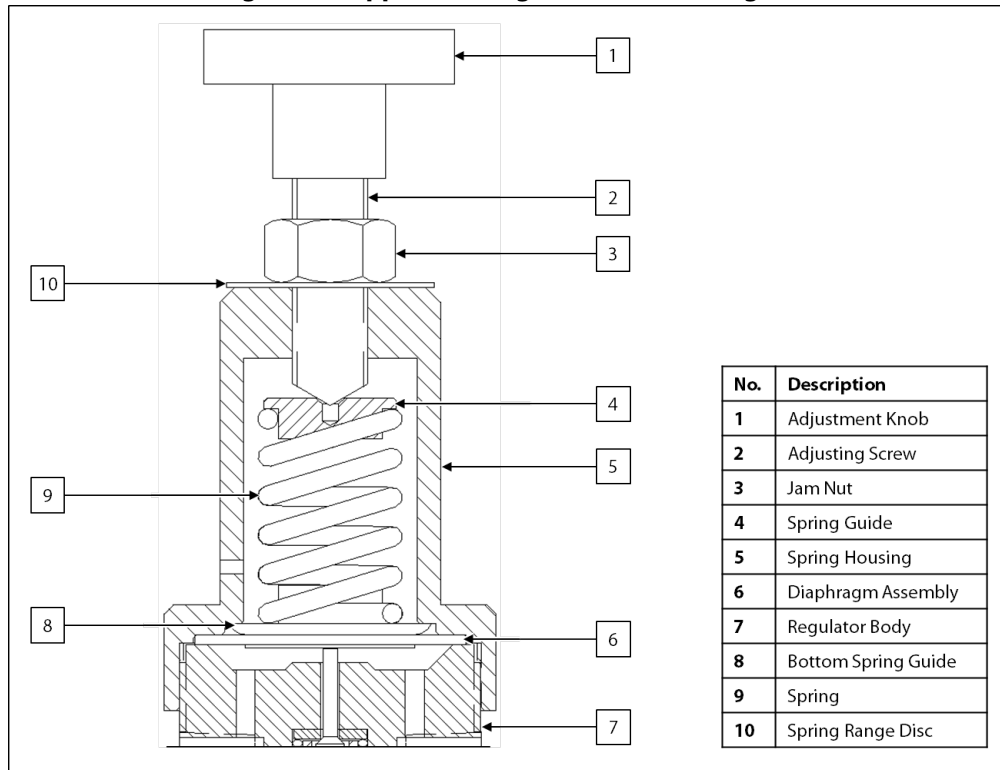
**Figure 11: Base Maintenance Diagram**



17. Replace the O-ring in the top of the base.
18. Remove the chamber insert and inspect it for any dents that would impede the flow of gas. Replace as necessary.
19. Return the chamber insert to the base, and then set the base aside.

## Upper Housing

**Figure 12: Upper Housing Maintenance Diagram**



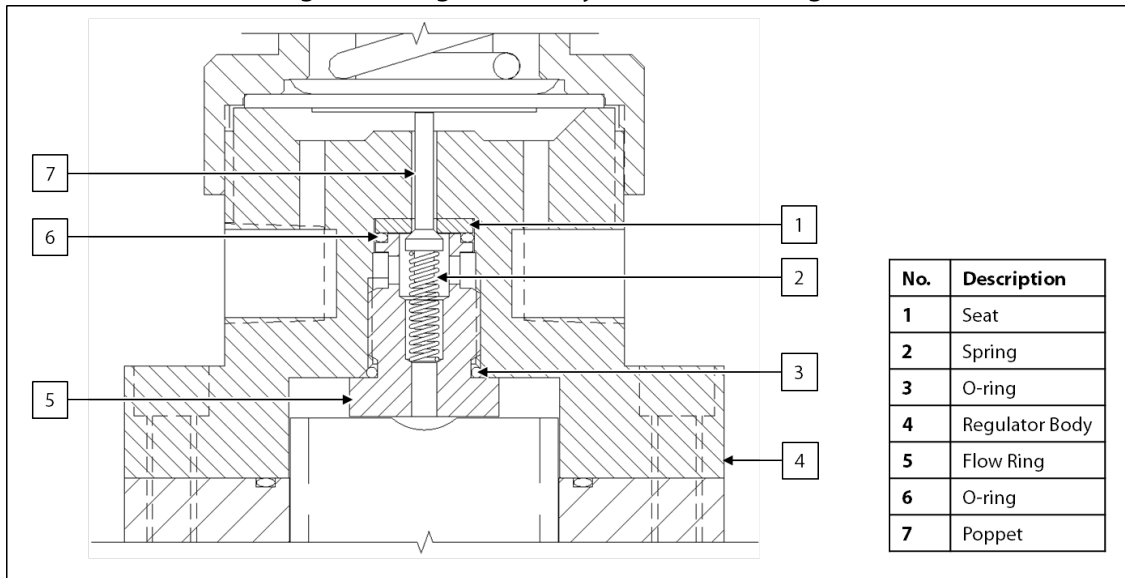
20. Loosen the jam nut on the adjusting screw.
21. In a counterclockwise direction, back off the adjusting screw to relieve tension on the spring.
22. As necessary, perform maintenance on the relief valve. Refer to the *Installation, Operation, and Maintenance (IOM) Manual* for the relief valve for maintenance instructions.
23. Separate the spring housing from the regulator body.
24. Remove the spring guides and spring.
25. Remove the diaphragm assembly.
26. Inspect the diaphragm for wear. Replace as necessary.
27. Place the diaphragm assembly on top of the regulator body with the bottom spring guide facing up.
28. Place the spring on the diaphragm assembly. Ensure that the spring is sitting on the bottom spring guide.
29. Return the spring guide to the top of the spring.
30. Install the spring housing to the regulator body.



When reassembling the upper housing, **HAND-TIGHTEN ONLY**.

## Regulator Body

**Figure 13: Regulator Body Maintenance Diagram**



31. Use a small hex key to loosen the flow ring.
32. Remove the flow ring, spring, and poppet.
33. Examine the seating face of the poppet for scratches or damage. Replace as necessary.



Debris or scratches on the poppet will prevent positive shutoff of the regulator.

34. Use a small pointed instrument to carefully remove the seat from the regulator body.
35. Inspect the seat for debris or scratches. Replace as necessary.

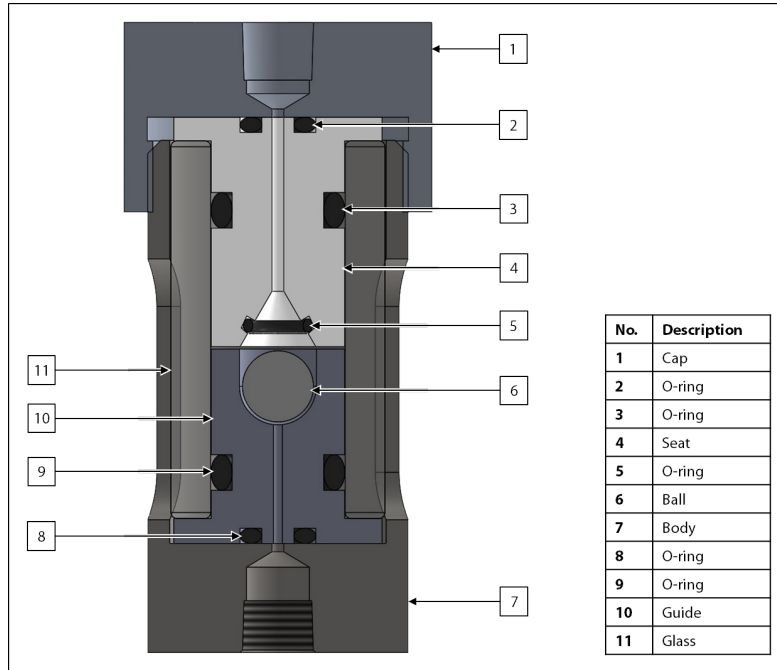


Debris or scratches on the seat will prevent positive shutoff of the regulator.

36. Replace the O-ring on the flow ring.
37. Install the seat to the regulator body.
38. Guide the poppet into the seat.
39. Return the spring to the poppet.
40. Return the flow ring to the regulator body and tighten firmly.

## Maintenance: ALS-1

Figure 14: ALS-1 Maintenance Diagram



41. Unscrew the cap from the body.
42. Carefully remove the seat, taking care not to scratch the glass, and then replace the O-rings on the seat.



DO NOT lubricate the O-ring on which the ball seals (Figure 14, #5).

43. Remove the glass.
44. Remove the guide from the body, and then replace the O-rings on the guide.
45. Inspect the ball for scratches or wear. Replace as necessary.
46. Return the ball to the guide.
47. Install the guide to the body.
48. Carefully install the glass over the guide.
49. Carefully insert the seat into the glass, taking care not to scratch the glass.
50. Return the cap to the body and hand-tighten.



When reassembling the ALS-1, HAND-TIGHTEN ONLY.

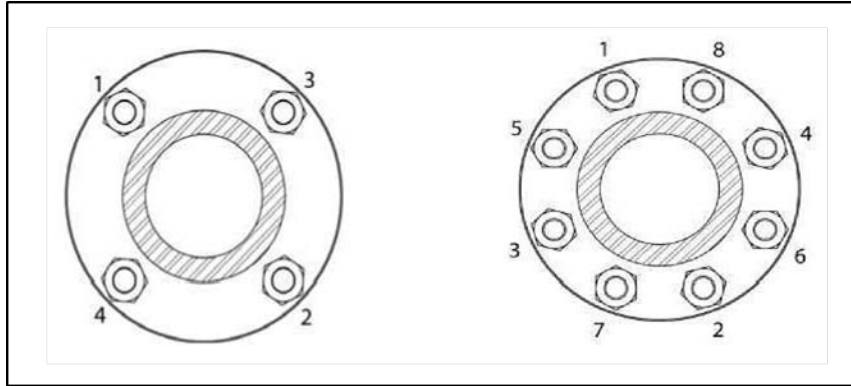
## Maintenance: Optional Temperature Transmitter Assembly

51. If the SCHS is equipped with the optional temperature transmitter assembly, refer to the *Installation, Operation, and Maintenance (IOM) Manuals* for the assembly components for maintenance instructions.

## **Reassembly**

52. Return the base to the LE-2SSKO in the pipeline (*Figure 9*).
53. Return the regulator subassembly to the top of the base (*Figure 9*).
54. Following a cross-bolting sequence, insert the eight (8) cap screws through the regulator body and base to the LE-2SSKO, and then tighten firmly (*Figure 9* and *Figure 15*).

**Figure 15: Cross-Bolting Sequence**



55. Install the ALS-1 to ALS isolation valve C (*Figure 2*).
56. Maintenance is now complete.
57. To complete reinstallation and return the SCHS to operation, see *Section 2.2, Installation and Operation*, for instructions.

### 3.3 Heater Failure



Neither the controller nor the heating element is prone to fail; however, failure is possible in instances of misuse and extreme malfunction of the electrical system.



If the controller or heating element fails, replacement is required.



When reassembling the electrical housing, all joints should be thoroughly cleaned and may be lightly lubricated with suitable grease, such as Crouse-Hinds STL Thread Lubricant, to prevent corrosion and assist in weatherproofing. Use only non-metallic scrapers and non-corrosive cleaning fluids to clean flanges. Keep blind holes clear of grease.

### Assessing the Controller

1. Ensure that all electrical power to the unit has been turned OFF and that the electrical wiring has been disconnected.



The heated regulator will be HOT after use. Allow approximately thirty (30) minutes for the regulator to cool down prior to performing maintenance.



DO NOT open the electrical housing until the surface temperature and any stored electrical energy have decayed to the point that it can no longer be a potential ignition source.



Ensure that the heated regulator is isolated from all incoming and outgoing connections (including neutral conductors) prior to opening the electrical housing.

2. Remove the cover from the electrical housing.
3. Disconnect the two (2) power supply leads from the terminal block.
4. As necessary, disconnect the customer-supplied tubing, fittings, or instrument attached to the unit.
5. Connect an appropriate electrical supply to prongs 2 and 4, and then use a multimeter to measure the current across prongs 1 and 4. If the current reads 0 A, the controller needs to be replaced; continue to step 6. If the current reads greater than 0 A, the heating element needs to be assessed for failure; proceed to step 10.

## Replacing the Controller

6. Ensure that all electrical power to the unit has been turned OFF and that the electrical wiring has been disconnected.



The heated regulator will be HOT after use. Allow approximately thirty (30) minutes for the regulator to cool down prior to performing maintenance.



DO NOT open the electrical housing until the surface temperature and any stored electrical energy have decayed to the point that it can no longer be a potential ignition source.



Ensure that the heated regulator is isolated from all incoming and outgoing connections (including neutral conductors) prior to opening the electrical housing.

7. Remove the cover from the electrical housing.
8. Disconnect the four (4) controller prongs from the terminal block, and then remove the failed controller.
9. Install a new controller to the electrical housing.

## Assessing the Heating Element

10. Ensure that all electrical power to the unit has been turned OFF and that the electrical wiring has been disconnected.



The heated regulator will be HOT after use. Allow approximately thirty (30) minutes for the regulator to cool down prior to performing maintenance.



DO NOT open the electrical housing until the surface temperature and any stored electrical energy have decayed to the point that it can no longer be a potential ignition source.



Ensure that the heated regulator is isolated from all incoming and outgoing connections (including neutral conductors) prior to opening the electrical housing.

11. Remove the cover from the electrical housing.
12. Disconnect the four (4) heating element leads from the terminal block.
13. Using a multimeter, measure the resistance across the two (2) black leads. If the resistance reads "OL" or " $\infty$ ," the heating element needs to be replaced; continue to step 14. If the resistance reads a numerical value, the heating element does not need to be replaced; proceed to step 22.

## Replacing the Heating Element

14. As necessary, disconnect the customer-supplied tubing, fittings, or instrument attached to the unit.
15. Remove the electrical housing from the heated regulator base and pull the heating element out of the base.
16. As necessary, clean the heating element chamber.
17. Prepare the replacement heating element for installation by cutting the leads to the necessary length and crimping on new terminal leads.
18. Lubricate the replacement heating element.



Welker recommends a silicone-based lubricant, such as Molykote® 111, for use with this unit.

19. Insert the replacement heating element into the heating element chamber and ensure that the heating element is fully inserted.
20. Run the leads through the electrical housing entry, and then install the electrical housing to the heated regulator base.
21. Connect the four (4) heating element leads to the terminal block.
22. With customer-supplied electrical power turned OFF, connect the appropriate leads to terminals 2 and 4 in the provided electrical housing (*Figure 7*).
23. Secure the cover to the electrical housing.



## APPENDIX A: REFERENCED OR ATTACHED DOCUMENTS

Welker® *Installation, Operation, and Maintenance (IOM) Manuals* suggested for use with this unit:

- IOM-069: Welker® LE-2SSKO Probe Mounted Liquid Eliminator
- IOM-077: Welker® ALS-1 Analyzer Liquid Shutoff
- IOM-078: Welker® HR-4SS Heated Instrument Regulator
- IOM-105: Welker® NV-1 and NV-2 Instrument Valves

Other *Installation, Operation, and Maintenance (IOM) Manuals* suggested for use with this unit:

- Ashcroft Inc. BI Series Bi-Metal Thermometers (Welker® IOM-V235)
- Generant Series VRV Vent Relief Valve (Welker® IOM-V175)
- INTERTEC™ MINIBOX 21 Transmitter Enclosure (Welker® IOM-V209)
- Rosemount Inc. 148 Temperature Transmitter (Welker® IOM-V045)
- Rosemount Inc. RTD and Thermocouple Assemblies (Welker® IOM-V031)
- WIKA Bourdon Tube Pressure Gauges Type 232.53 and Type 233.53 (Welker® IOM-V171)

Welker® drawings and schematics suggested for use with this unit:

- Assembly Drawing: AD822BU (Standard SCHS)
- Assembly Drawing: AD822BZ (SCHS With Optional Temperature Transmitter Assembly)

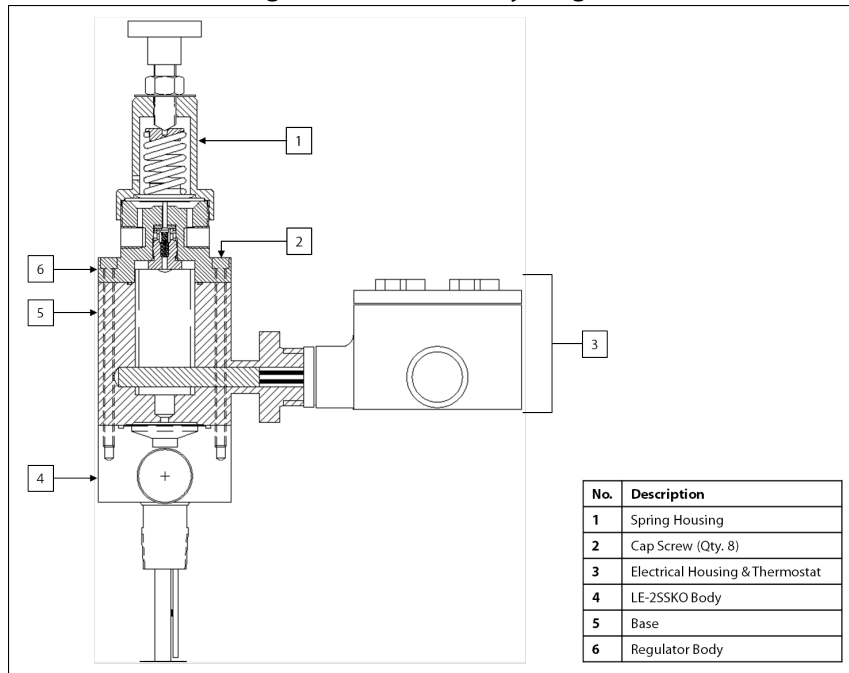
## APPENDIX B: PREPARING THE SCHS FOR INSTALLATION IN LOCATIONS WITH LIMITED CLEARANCE

1. Unscrew the cap screws from the collar below the Welker® LE-2SSKO Probe Mounted Liquid Eliminator, and then set the two-piece collar aside.
2. Remove the eight (8) cap screws from the regulator body (*Figure B1*).



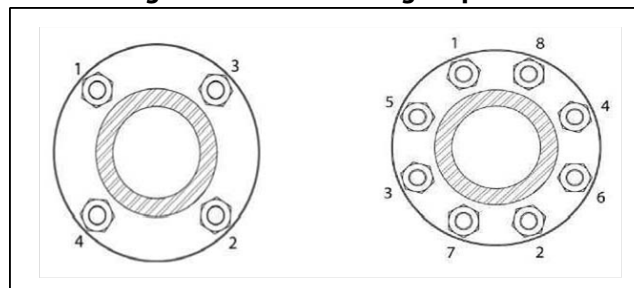
Removing the adjustment knob from the regulator will ease the removal of the eight (8) cap screws.

**Figure B1: Disassembly Diagram**



3. Rotate the Welker® HR-4SS Heated Instrument Regulator and attached Welker® ALS-1 Analyzer Liquid Shutoff 180° on the LE-2SSKO.
4. Following a cross-bolting sequence, insert the eight (8) cap screws through the regulator body and base to the LE-2SSKO, and then tighten firmly (*Figure B1* and *Figure B2*).

**Figure B2: Cross-Bolting Sequence**



5. Install the two-piece lock collar below the Welker® LE-2SSKO so that the piece of the lock collar that connects to the enclosure hinge is 180° from the HR-4SS.
6. To continue installation of the SCHS, return to *Section 2.2, Installation and Operation*, for instructions.

**NOTES**

---

---

---

---

---

---

---

---

---

---

---

---

---

---

---

---

---

---

---

---

---

---

---

---

---

---

---

---

---

---



13839 West Bellfort Street  
Sugar Land, TX 77498  
Phone: 281.491.2331

welker.com