



*Installation, Operation, and
Maintenance Manual*

***Welker[®] Probe-Mounted Liquid Eliminator
with Liquid Shut-off
Model
LE-2SSKO with ALS***

***Drawing No.: AD126EF
Manual No.: IOM-164***

The information in this manual has been carefully checked for accuracy and is intended to be used as a guide for the installation, operation, and maintenance of the Welker[®] equipment described above. Correct operating and/or installation techniques, however, are the responsibility of the end user. Welker[®] reserves the right to make changes to this and all products in order to improve performance and reliability.

This manual is intended to be used as a basic installation and operation guide for the Welker[®] Probe-Mounted Liquid Eliminator with Liquid Shut-off, *LE-2SSKO with ALS*. For comprehensive instructions, please refer to the IOM Manuals for each individual component. A list of relevant component IOM Manuals is given in the Appendix section of this manual.

13839 West Belfort
Sugar Land, TX 77498-1671
(281) 491-2331 - Office
(800) 776-7267 - USA Only
(281) 491-8344 - Fax
<http://www.welkereng.com>

TABLE OF CONTENTS

<u>1.</u>	<u>SPECIFICATIONS</u>	<u>3</u>
1.1	INTRODUCTION	3
1.2	DESCRIPTION OF PRODUCT	3
1.3	SPECIFICATIONS	4
1.4	SYSTEM DIAGRAMS	4
<u>2.</u>	<u>INSTALLATION & OPERATIONS</u>	<u>5</u>
2.1	BEFORE YOU BEGIN	5
2.2	INSTALLATION	6
2.3	OPERATIONS	6
2.4	RETRACTION & REMOVAL FROM PIPELINE	6
<u>3.</u>	<u>MAINTENANCE</u>	<u>8</u>
3.1	BEFORE YOU BEGIN	8
3.2	MAINTENANCE	8
3.3	EMERGENCY SHUT-OFF	10
<u>APPENDIX</u>		<u>11</u>
REFERENCED OR ATTACHED WELKER® IOMS		11
REFERENCED OR ATTACHED BUY-OUT IOMS		11
REFERENCED OR ATTACHED DRAWINGS		11

Welker®, Welker Jet®, and WelkerScope® are Registered Trademarks owned by Welker, Inc.

Section 1: SPECIFICATIONS

1.1 INTRODUCTION

We appreciate your business and your choice of Welker® products. The installation, operation, and maintenance liability for this product becomes that of the purchaser at the time of receipt. Reading the applicable *Installation, Operation, and Maintenance (IOM) Manual* prior to installation and operation of this equipment is required for a full understanding of its application and performance prior to use.*

If you have any questions, please call 1-800-776-7267 (USA) or 1-281-491-2331.

Notes, Cautions, and Warnings



Notes emphasize information or set it off from the surrounding text.



Caution messages appear before procedures that, if not observed, could result in damage to equipment.



Warnings are alerts to a specific procedure or practice that, if not followed correctly, could cause personal injury.

*The following procedures have been written for use with standard Welker® parts and equipment. Assemblies that have been modified may have additional requirements and specifications that are not listed in this manual.

1.2 DESCRIPTION OF PRODUCT

The Welker® Probe-Mounted Liquid Eliminator with Liquid Shut-off is designed to condition gas samples for an analyzer. This product combines an adjustable, manual insertion sample probe; an LE-2SSKO style liquid eliminator with isolation valves; and an analyzer liquid shutoff (ALS). The liquid eliminator is designed to collect a sample of gas from the pipeline while returning any liquids to the pipeline. To protect the analyzer from potential liquid damage, the ALS allows gases to pass through but will shut off if any liquid passes the liquid eliminator and enters the ALS.

1.3 SPECIFICATIONS



The specifications listed in this section are generalized for this equipment. Welker® can modify the equipment according to your company's needs. However, **please note that the specifications may vary depending on the customization of your product.**

Table 1: System Specifications	
Products Sampled	Gas
Materials of Construction	316/316L Stainless Steel, Carbon Steel, Teflon®, Kalrez®, Glass (ALS)
Maximum Allowable Operating Pressure	285 psi @ -20° to 100°F (20 bar @ -29° to 38°C)
Maximum Allowable Operating Temperature	130°F @ 277 psig (55°C @ 19 bar)
Maximum Allowable Insertion Pressure	For Manual Insertion: 110 psig (7.6 bar)
Probe Connection	1"-150 RF Standard Others available upon request.

1.4 SYSTEM DIAGRAMS

Figure 1: System Diagram

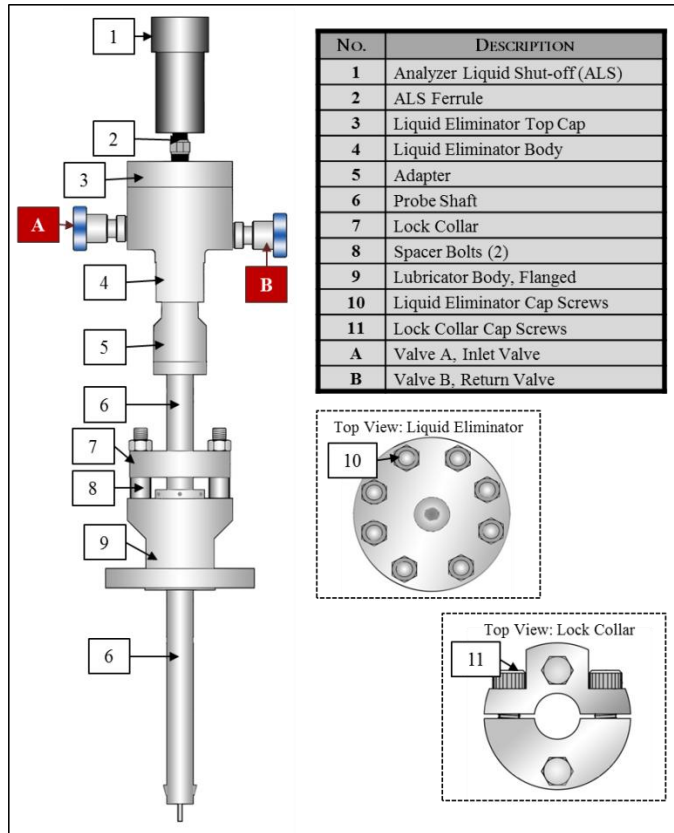

REFER TO *FIGURE 1* AND *DRAWING AD126EF* THROUGHOUT THIS MANUAL.

Figure 2: Recommended General Arrangement

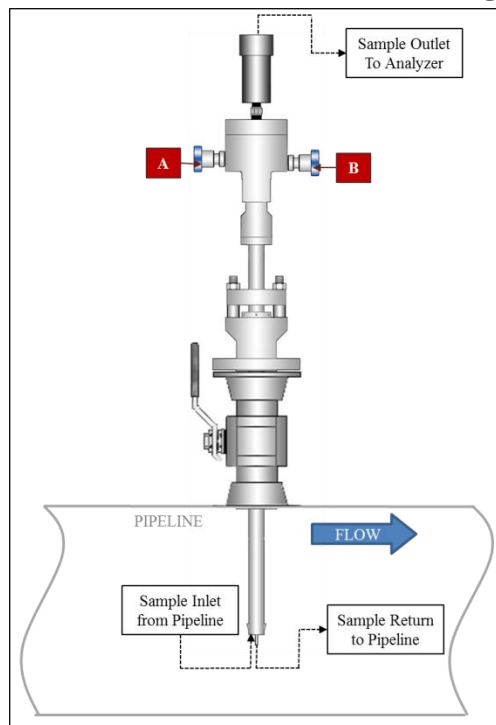

Section 2:

INSTALLATION & OPERATIONS

2.1 BEFORE YOU BEGIN



After unpacking the unit, check the equipment for compliance and for any damage that may have occurred during shipment. **Claims for damage caused during shipping must be initiated by the receiver and directed to the shipping carrier.** Welker[®] is not responsible for any damage caused by mishandling by the shipping company.



When sealing fittings with PTFE tape, refer to the proper sealing instructions for the tape used.

1. Welker[®] recommends that the probe be installed in such a way as to extract the sample from the center one-third (1/3) of the pipeline or wherever the collected sample will be representative of the product as a whole.
2. The probe should be installed upright in the top of the pipeline.
3. The preferred location for installation is in a straight section of inlet piping upstream of any point at which the flowing stream is subjected to turns and impingements. Any such impingement may result in aerosols that may produce a sample that is not representative of the gas in the pipeline.
4. The probe should be located in the least turbulent area of the flowing stream available (i.e., not in a header or blow-down stack and away from obstructions, elbows, or partially closed valves).

2.2 INSTALLATION

Positioning the stop collar (*Figure 3*):

1. Before installing the probe, the length the insertion probe will need to travel inside the pipeline must be determined. Measure the distance the probe must travel from the top of the pipeline isolation valve to the desired insertion depth (e.g., center 1/3 of the pipeline). This will be the probe insertion length.
2. Ensure that the probe is fully retracted. The probe tip should be flush with the bottom of the adapter.
3. Beginning at the top of the body, measure up on the probe from the bottom of the probe tip to the desired insertion length. It may help to mark this point with a felt-tip pen.
4. Loosen the two set screws in the stop collar, and move the bottom of the stop collar to the desired probe insertion length, or the mark made in Step 3.
5. Tighten the set screws in the stop collar to hold the stop collar in place on the shaft.

Figure 3: Positioning the Lock Collar

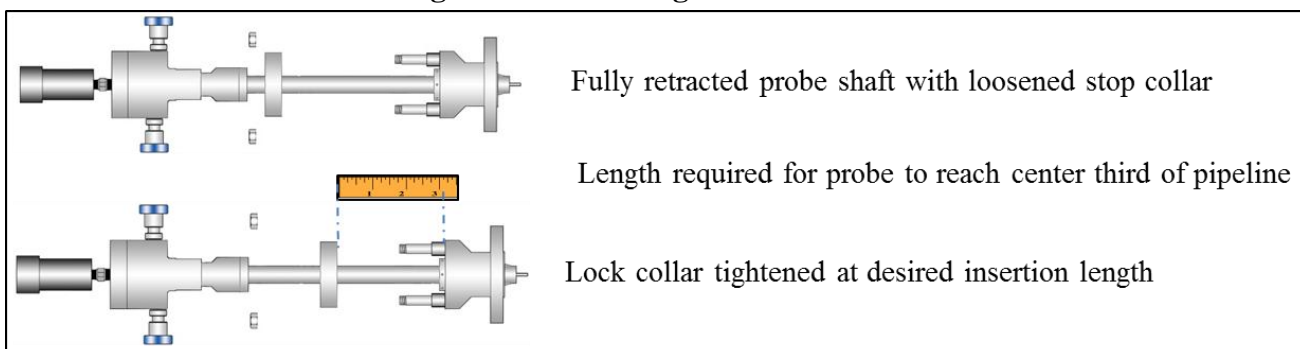

Installing the Probe:

1. Ensure that all valves are closed.
2. With the pipeline isolation valve closed and the probe shaft fully retracted, bolt the probe onto the pipeline flanged connection at the desired location. Install the probe in a manner consistent with the recommendations given in Section 2.1.
3. Depressurize the pipeline to approximately 100 psi for safe manual insertion.



Ensure the pipeline is depressurized to below 110 psig for safe manual installation. Inserting the probe at a pipeline pressure greater than 110 psig may result in injury to the operator or damage to the equipment.

4. Slowly open the pipeline isolation valve.
5. Firmly push the shaft into the pipeline.



When pushing the shaft into the pipeline, push straight downward; do not allow the shaft to bend. Do NOT insert the probe at pressures higher than the pressure specified in Table 1 of these instructions.

6. Tighten the stop collar spacer bolts to lock the stop collar in place. Continue to push downward on the shaft until the stop collar is locked in place

Figure 4: Locking the Lock Collar

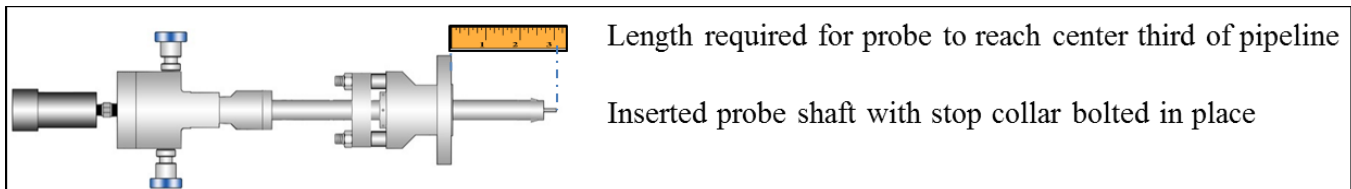

7. Purge and pressurize the pipeline according to company policy and standards.
8. Connect customer-supplied tubing from the sample outlet to the analyzer or pressure regulator.

2.3 OPERATION

1. Open the two isolation valves, A and B, on the liquid eliminator.
2. Check the system for leaks, especially between the pipeline connection and probe. Repair as necessary.
3. Set the regulator on the analyzer, and purge the line to the analyzer according to company policy and standards.
4. During operation, observe the ball in the ALS (*Figure 5*). If the ball rises to shut off the ALS, indicating that liquid has entered the system, cease operation and perform maintenance on the system.

2.4 RETRACTION & REMOVAL FROM PIPELINE

Retracting the Probe:

1. Depressurize the pipeline to approximately 100 psi for safe retraction.



Ensure the pipeline is depressurized to below 110 psig for safe manual retraction. Retracting the probe at a pipeline pressure greater than 110 psig may result in injury to the operator or damage to the equipment.

2. Push downward on the unit, and simultaneously loosen the stop collar bolts.



Failure to maintain downward force on the probe unit while loosening the lock collar may cause the probe to retract too quickly, possibly resulting in damage to the equipment or injury of personnel.

3. Slowly allow pipeline pressure to push the probe shaft out of the pipeline. Gently pull up on the probe shaft as needed until the probe is fully retracted.



Maintain downward pressure and allow the probe to retract slowly; do not allow the shaft to bend. Do NOT retract the probe at pressures higher than the pressure specified in Table 1 of these instructions.

4. Close the pipeline isolation valve.



Ensure the probe is fully retracted prior to closing the isolation valve. Failure to fully retract the probe shaft prior to closing the isolation valve is the leading cause of damage to Welker[®] probes.

5. Open the valve on the probe to relieve any remaining pressure from the probe.
6. Unbolt the unit from the flanged pipeline connection. The unit is now ready for maintenance or to be moved to another location.

Section 3: MAINTENANCE

3.1 BEFORE YOU BEGIN

1. **Welker® recommends that the unit have biannual maintenance under normal operating conditions.** In cases of severe service, dirty conditions, excessive usage, or other unique applications that may lead to excess wear on the unit, a more frequent maintenance schedule may be appropriate.
2. Prior to maintenance or disassembly of the unit, it is advisable to have a repair kit available for repairs of the system in case of unexpected wear or faulty seals.



New seals supplied in spare parts kits are not lubricated. They should be lightly coated with lubrication grease before installation. Welker® recommends silicone grease (DOW CORNING® 111 or an equivalent lubricant) for use with this unit.

3. All maintenance and cleaning of the unit should be done on a smooth, clean surface.
4. It is advisable to have the following tools available for maintenance of this unit. Tools needed may vary depending on the product model.
 - Small pick, knife or other pointed instrument

3.2 MAINTENANCE

1. Close the two isolation valves, A and B, on the liquid eliminator (*Figure 1*).
2. If maintenance is needed on the lower housing or probe shaft, refer to Section 2.4 to retract the unit from the pipeline. Most routine maintenance can be performed without retracting the unit.
3. Remove all tubing and fittings connected to the system.
4. Unscrew the ALS from the hex nipple.
5. Unscrew the hex nipple from the liquid eliminator, and lift the ALS away from the liquid eliminator.

ALS Maintenance (*Figure 5*):

1. Unscrew and remove the top cap of the ALS.
2. Remove the glass assembly. Polish gently with a clean, dry cloth as necessary.
3. Remove and replace all seals in the device.
4. Remove the ball. Examine the ball for scratches or wear. Replace as necessary.
5. Reinsert the ball into the guide.
6. Reinstall the glass assembly inside the cap.
7. Hand-tighten the cap to the body. Set the ALS aside.

Figure 5: ALS Maintenance Diagram

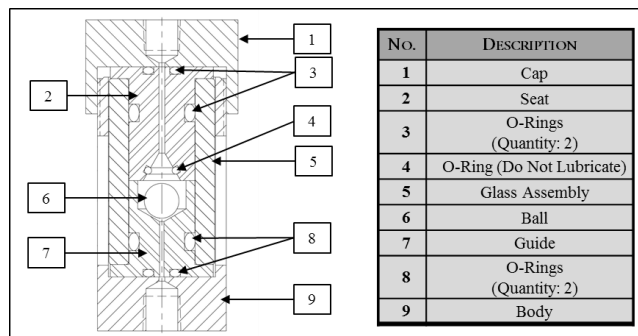

Liquid Eliminator Maintenance (Figure 6):

8. Unscrew the eight cap screws from the liquid eliminator top cap, and lift the top cap away to expose the screen.
9. Remove the screen on the liquid eliminator.
10. Use a pick or small knife to remove the O-ring.
11. Remove the copolymer filter element.
12. Use solvent to clean the inside of the liquid eliminator. Do not leave any residue, which may prevent the unit from functioning properly when the device is pressurized.
13. Center the copolymer filter inside the liquid eliminator.
14. Replace the O-ring.
15. Center the screen over the center of the element.
16. Set the liquid eliminator top cap on top of the screen.
17. Screw the eight cap screws into the liquid eliminator top cap in a crisscross bolting pattern. Set the liquid eliminator aside.

Figure 6: Liquid Eliminator Maintenance Diagram

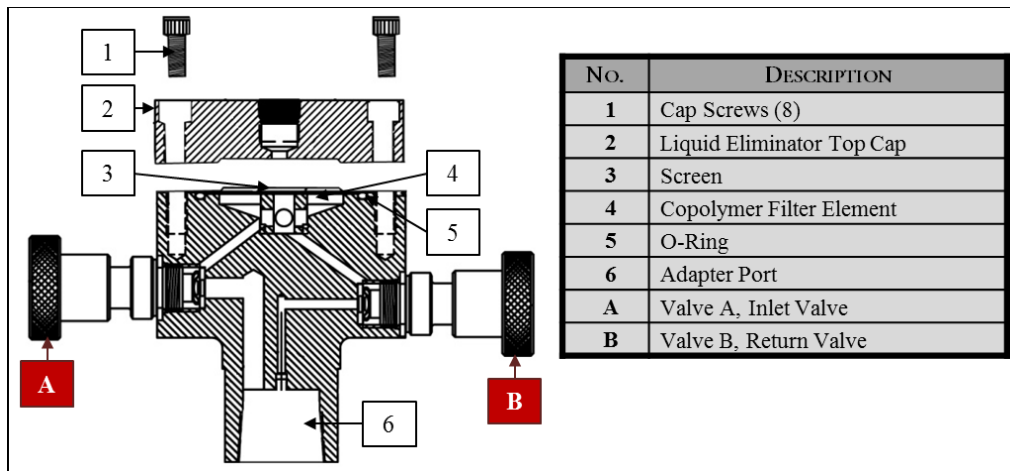

Adapter Maintenance (Figure 7):

1. Unscrew the liquid eliminator from the adapter.
2. Unscrew the two set screws in the adapter locking clamp.
3. Remove the adapter locking clamp from the bottom of the adapter. Be careful not to lose the small adapter pin when separating the adapter and the adapter locking clamp.
4. Gently slide the probe shaft out of the adapter. The lock collar and lubricator body should stay attached to the probe at this time.
5. Replace the O-ring in the adapter body. Set the adapter aside.

Figure 7: Adapter Maintenance Diagram

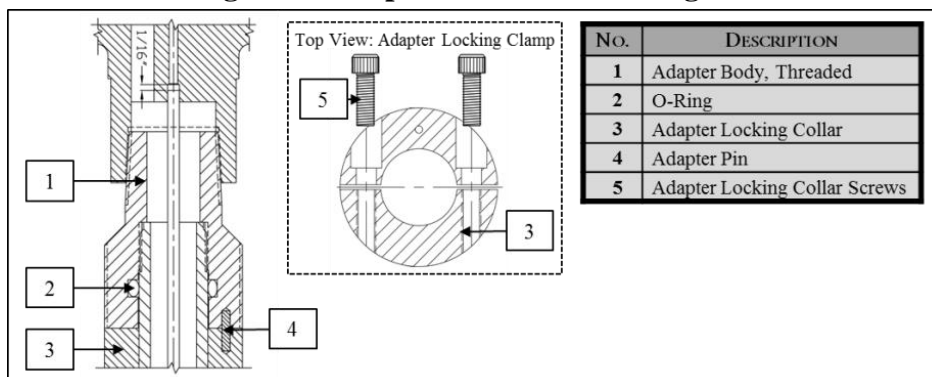

Lower Housing Maintenance (Figure 8):

1. Remove the lock collar set screws from the lock collar, and then remove the lock collar from the probe shaft.
2. Inspect the probe shaft for scratches and polish or replace as necessary.
3. Gently slide the probe shaft out of the lubricator body.
4. As needed, replace the wiper ring at the top of the packing adjustment nut.
5. As needed, remove the packing adjustment nut and replace the packing, then screw the packing adjustment nut back into the lubricator body.
6. Replace the O-ring in the lubricator body.

Figure 8: Lower Housing Maintenance Diagram

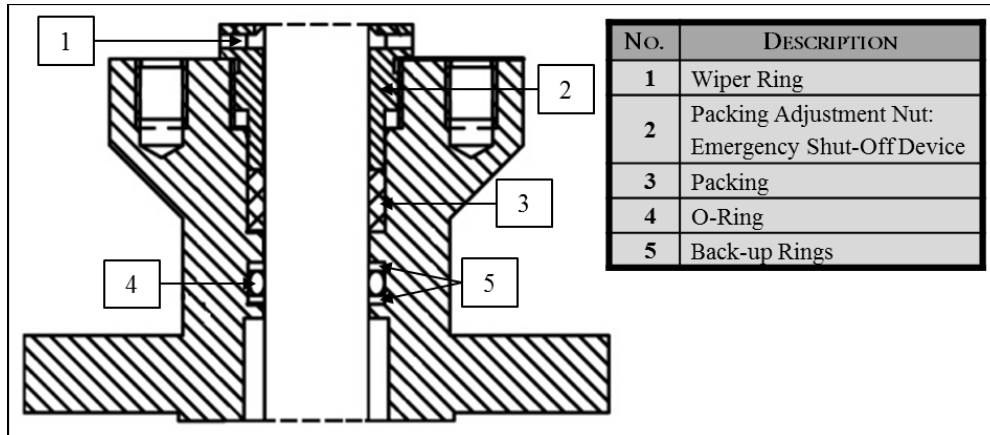

Reassembly:

7. Gently slide the probe shaft back through the lubricator body.
8. Attach the lock collar back onto the probe shaft, leaving it slightly loose.
9. Screw the adapter back onto the probe shaft.
10. Screw the liquid eliminator back onto the adapter.
11. Screw the hex nipple into the outlet port of the liquid eliminator.
12. Screw the ALS inlet onto the hex nipple.
13. Screw the adapter into the adapter port of the liquid eliminator.
14. Reconnect all necessary tubing and fittings. Refer to Section 2 for installation and operation instructions.

3.3 EMERGENCY SHUT-OFF

1. If noticeable leaking occurs at the lower housing, tighten the adjustment packing nut (Figure 8).
2. The adjustment packing nut emergency shut-off is a temporary measure only. As soon as possible, retract the unit from the pipeline and perform maintenance as needed on the lower housing.

APPENDIX

ATTACHED DOCUMENTS:

Welker® *Installation, Operation, and Maintenance* Manuals suggested for use with this unit:

- None

Other *Installation, Operation, and Maintenance* Manuals suggested for use with this unit:

- None

Welker® drawings and schematics suggested for use with this unit:

- Assembly Drawing: AD126EF



13839 West Bellfort
Sugar Land, TX 77498-1671
Phone: (281) 491-2331
Fax: (281) 491-8344
Toll Free: (800) 776-7267
Web Page: www.welkereng.com