

**Honeywell**

MIWI350



## MIWI350 Installation and Operations Guide

FD-610 | Version 5.0 | December 2022

Honeywell Process Solutions | Mercury Instruments

2101 Citywest Boulevard Houston, TX 77042 USA

855 251-7065 – United States & Canada | 302 669-4253 – Outside the United States

<https://process.honeywell.com>

Copyright 2022. Honeywell Process Solutions. All rights reserved.

Information in this document is subject to change without notice. The software described in this document is furnished under a license agreement or non-disclosure agreement. The software may be used or copied only in accordance with the terms of those agreements. No part of this publication may be reproduced, stored in a retrieval system, or transmitted in any form or any means electronic or mechanical, including photocopying and recording for any purpose other than the purchaser's personal use without the written permission of Honeywell Process Solutions.

## Version Changes List

Document Name	Document ID	Description	Version Number	Publication Date
MIWI350 Operating and Installation Guide	FD-600	Initial Draft	1.00	Feb 2018
MIWI350 Operating and Installation Guide	FD-610	R100 release	2.00	Mar 2019
MIWI350 Operating and Installation Guide	FD-610	R110.1 release	2.50	Sep 2020
MIWI350 Operating and Installation Guide	FD-610	R110 release	3.00	Nov 2020
MIWI350 Operating and Installation Guide	FD-610	R120.0 release	4.00	Jan 2022
MIWI350 Operating and Installation Guide	FD-610	R150 release	5.00	July 2022

# CONTENTS

<b>1 About MIWI350</b> .....	<b>1</b>
1.1 Product Features .....	1
1.2 Power Supply Options .....	1
1.3 Abbreviations .....	1
1.4 Specifications .....	2
1.4.1 Power Input Sources and Options .....	2
1.4.2 Audit Trail .....	3
1.4.3 Certifications .....	3
1.4.4 Wiring Guidelines for AC Input .....	4
1.4.5 Environmental .....	5
1.4.6 Temperature Measurement .....	6
1.4.7 Pressure Measurement .....	6
1.5 Safety Measures .....	8
1.5.1 Safety and Hazardous Information .....	8
1.5.2 Conditions of Acceptability .....	8
1.5.3 Warning-Explosion Hazard/Avertissement - Risque d'explosion ...	8
1.5.4 Things to Remember .....	9
1.5.4.1 Usage of MIWI350 in Hazardous Areas .....	9
1.5.4.2 Installation and Commissioning of MIWI350 in Hazardous Areas .....	9
1.5.4.3 Instructions for Installation in Zone 2 Location as per IECEX Certification .....	9
1.5.4.4 Service, Maintenance, and Troubleshooting .....	9
<b>2 Security Control Measures</b> .....	<b>11</b>
<b>3 Installation</b> .....	<b>14</b>
3.1 Unpacking .....	14
3.2 Mounting Options .....	14
3.2.1 Device Marking .....	15
3.3 Zone2 installation .....	16
<b>4 Mechanical Assembly and User Interface</b> .....	<b>18</b>
4.1 Device Dimensions & Weights .....	19
4.2 Display Options .....	21
4.2.1 HMI User Interface .....	22
4.3 Gland Entries .....	25
4.3.1 Power Input .....	25
4.3.2 Temperature Input .....	26
<b>5 Electrical Assembly</b> .....	<b>28</b>
5.1 Input or output board .....	28
5.2 Power Distribution Board .....	29
5.2.1 Power Distribution Board connections for Solar-Input/AC-DC input with lead acid battery back up .....	31
5.2.2 Power Distribution Board jumper settings for Alkaline Battery or DC input .....	32
5.2.3 Power Distribution board Output voltage and Jumper settings ...	33
5.3 MODEM .....	33
<b>6 Remote Pulser</b> .....	<b>34</b>
6.1 Pulser to MIWI cable connections .....	35
<b>7 Internal Wiring</b> .....	<b>38</b>
7.1 Power Distribution Board and IO Board .....	38
7.2 Power Distribution Board and Modem .....	38
7.3 IO Board and MODEM .....	40
<b>8 Battery Installation</b> .....	<b>42</b>
8.1 Lead-Acid Battery .....	42

# CONTENTS

8.2 Dual/Quad Alkaline Battery .....	43
8.3 Battery Life (approximate) .....	44
<b>9 SLA Alarm Scenarios .....</b>	<b>45</b>
<b>10 Reference Drawings .....</b>	<b>47</b>
10.1 MIWI350 with EC350 or ERX350 .....	47
10.1.1 Wiring Dual or Quad Battery .....	47
10.1.2 Wiring Solar or External DC Power (13.5 to 15V DC) for MIWI35049	
10.1.3 Wiring AC-DC Power for DIV2 .....	50
10.1.4 Wiring AC-DC Power for DIV2 .....	51
10.1.5 Wiring AC-DC Power for Zone2 .....	53
10.1.6 Wiring External DC Power .....	55
10.2 MIWI350 as Power Box .....	56
10.2.1 Wiring Dual or Quad Battery for MIWIPCB .....	56
10.2.2 Wiring Solar or External DC (13.5 to 15V DC) Power for MIWIPCB .....	58
10.2.3 Wiring AC DC Power for MIWIPCB .....	59
10.2.4 Wiring External DC Power for MIWIPCB .....	60
10.3 MIWI350 as Power or Communication Box .....	61
10.3.1 Barrier Connections .....	61
10.3.1.1 With CloudLink MODEM .....	61
10.3.1.2 With CloudLink 4G M1 MODEM .....	62
10.3.1.3 With RV50/RV50X/RV55 MODEM .....	64
10.3.2 Terminal Block Connections .....	67
10.3.2.1 With CloudLink MODEM .....	67
10.3.2.2 With CloudLink 4G M1 MODEM .....	68
10.3.2.3 With RV50/RV50X/RV55 MODEM .....	70
<b>11 Configuration Software .....</b>	<b>72</b>
<b>12 350S Audit Trail Log support for CloudLink MODEM .....</b>	<b>73</b>
<b>13 As Shipped Configuration Reload Procedure .....</b>	<b>76</b>
<b>14 Orderable Kits .....</b>	<b>78</b>

# 1 About MIWI350

The MIWI350 is the latest offering in the Honeywell's EVC Product Line. This product line provides a more competitive, reliable, and easy to use solution. It provides a comprehensive selection of communication hardware and power supply systems optimized to integrate with the Mercury Instruments precision measurement instrumentation. It also includes software for Remote Monitoring and Data Acquisition (RMADA), including alarm handling and notification.

The MIWI350 device typically includes:

- An integrated Electronic Volume Corrector or Electronic Recorder (using electronics from the Honeywell EC350/ERX350)
- An integrated electronic cellular MODEM

## 1.1 Product Features

- IECEx Class1 Zone2 Group IIB Certification
- CSA C/US Class 1, Division 2, Group C & D certification
- Compatible with MasterLink and PowerSpring software
- Available in UMB (Universal Mounting Bracket), Wall, Pipe, and Portable mounting options
- Internal or External Mounted Display
- MODEM Power Control through Power Distribution Board
- Optional Backup Battery for Uninterrupted EVC Functionality
- Pressure Expansion (PE) Board for Third Pressure, P3

## 1.2 Power Supply Options

- AC/DC or External 12V DC Power Supply (For Quick Start Guide Refer FD-611)
- Solar Power with rechargeable Sealed Lead-Acid Battery (For Quick Start Guide Refer FD-612)
- Battery - Alkaline Packs (Dual/Quad) (For Quick Start Guide Refer FD-613)
- Power - Communication box (For Quick Start Guide Refer FD-614)

## 1.3 Abbreviations

AC	Alternating Current
AT	Audit Trail
CL	CloudLink
CLR100	CloudLink 4G MODEM
CLR110	CloudLink 4G M1 MODEM
CORR.VOL	Corrected Volume
CSA	Canadian Standards Association
DC	Direct Current
DoS	Denial-of-Service
ELV	Extra Low Voltage

EVC/EC	Electronic Volume Corrector / Electronic Corrector
FCC	Federal Communications Commission
HMI	Human Machine Interface
I/O	Input/Output
IOB	Input/Output Board
LAN	Local Area Network
LED	Light emitting diode
MC	Metrological Configuration
MDM	Mobile Device Management
MIWI350	MI Wireless with Gas Volume Correction functionality
MIWIPCB	MIWI Power and Communication Box
MPC	MODEM Power Control
MSG	Model Selection Guide
PD Board	Power Distribution Board
RF	Radio Frequency
SLA	Sealed Lead Acid
UMB	Universal Mounting Bracket
PE	Pressure Expansion
PWA	Printed Wiring assembly
SELV	Safety Extra Low Voltage
TAC	Tower Area Code
TCP	Transmission Control Protocol
UDP	User Datagram Protocol
UL	Underwriters Laboratories
VPN	Virtual Private Network

## 1.4 Specifications

### 1.4.1 Power Input Sources and Options

Configuration	Source/Battery Type	Voltage (VDC)	Battery Backup	Type	Backup Battery Voltage (VDC)	Ampere Hours (Ah)	Battery Power usage
*Dual pack with Supercap	Alkaline	18					EVC & MODEM

Configuration	Source/Battery Type	Voltage (VDC)	Battery Backup	Type	Backup Battery Voltage (VDC)	Ampere Hours (Ah)	Battery Power usage
*Quad pack with Supercap	Alkaline	18					EVC & MODEM
Backup Battery	Alkaline	6	Yes	Alkaline	6		EVC only as backup
Solar with SLA Battery	Solar Panel	15	Yes	Lead-Acid	12	7/21	EVC & MODEM
AC/DC with SLA Battery	AC Input	15	Yes	Lead-Acid		7/21	EVC & MODEM
External 12V DC	DC Input	12	Yes	Alkaline	6		EVC only as backup

**Note:** For more details on EC350 specifications refer [User Manual](#) and [Datasheet](#).

**Note:** For Dual pack with Supercap and Quad pack with Supercap, power source is not supported for MIWI350 Zone 2 variant.

**Warning:** Ensure that **Alkaline** battery type is selected while configuring SLA External Supply input through MasterLink software.

## 1.4.2 Audit Trail

2MB memory is reserved for AT logs.

The device supports five AT logs. A maximum of 20 items can be configured in one AT log.

## 1.4.3 Certifications

### Metrology

Measurement Canada (approval pending)

### Haz Loc Certifications

CSA C/US Class I, Division 2, Groups C and D, T3C

IECEX Class I, Zone 2 Group IIB (approval pending)

### Wireless Certification (IC & FCC)

#### Max RF POWER of the MODEM

CLR100: 25dBm/316mW ; CLR110: 23dBm/200mW

RV50/RV55 MODEM: 32dBm/1600mW ; RV50X MODEM: 23dBm/200mW

**Industry Canada:** IC ICES-003

**FCC:** Part 15 B Class-A Digital device



This device complies with Part 15 of the FCC Rules. Operation is subject to the following two conditions:

1. This device may not cause harmful interference, and;
2. This device must accept any interference received, including interference that may cause undesired operation.

**Note:** This equipment has been tested and found to comply with the limits for a Class A digital device, pursuant to part 15 of the FCC Rules. These limits are designed to provide reasonable protection against harmful interference in a residential installation. This equipment generates—and can radiate—radio frequency energy and, if not installed and used in accordance with the instructions, may cause harmful interference to radio communications. However, there is no guarantee that interference will not occur in a particular installation.

**Warning:** Changes or modifications to this unit not expressly approved by the party responsible for compliance could void the user's authority to operate the equipment.

**Caution:** This equipment has been tested. It complies with Part 15 of the FCC Rules. These limits are designed to provide reasonable protection against harmful interference in a residential installation. This device generates, uses and radiates radio frequency energy. If this device is not installed and used in accordance with the instructions, it can cause harmful interference to radio communications. However, there is no guarantee that interference will not occur in installation.

**Note:** The radiated output power of the device is far below the exposure limits. Nevertheless, use the device in such a manner that the potential for human contact during normal operation is minimal.

#### 1.4.4 Wiring Guidelines for AC Input

##### Over current protection

It is required to install an input fuse in-order to protect the equipment from Over current and short circuit. Recommended Fuse is as below:

INPUT	FUSE RATING	VOLTAGE RATING
230VAC	1A	250VAC Slow blow fuse
120VAC	1.5A	250VAC Slow blow fuse
12VDC	2A	250VAC Slow blow fuse

##### 230/120AC Input Cable Specification

It is required to use a UL/CSA approved cable with working voltage spec of min 300V. Cable shall be protected with an outer sheath.

**Warning:** For AC Input variant, readily accessible two-poled disconnect device must be incorporated in the fixed wiring.

### 1.4.5 Environmental

Maximum Operating Temperature Range (see listed configurations below):

-40 °F to +140 °F (-40 °C to +60 °C).

For your reference, the Operating Temperature Range for different assemblies are as below:

#### Ambient Temperature vs Assembly Code Table

Assembly code (ACXX) <sup>1</sup>	Ambient Temperature Range (°F)	Ambient Temperature Range (°C)	Assembly Description <sup>2</sup>
AC01	-4 to 113	-20 to 45	EVC, Modem, Barrier, and 21Ah SLA Battery
AC02	5 to 113	-15 to 45	EVC, Battery, Barrier, and 7Ah SLA Battery
AC03	-4 to 131	-20 to 55	EVC, Modem, and Barrier <sup>3</sup>
AC04	-22 to 140	-30 to 60	EVC, RV50/RV50X/RV55 Modem <sup>3</sup>
AC05	-40 to 140	-40 to 60	EVC and CL4G Modem <sup>3</sup>
AC06	-14 to 113	-10 to 45	EVC, Modem, Barrier, and 21Ah SLA Battery and AC-DC

1. The assembly code (ACXX) is also mentioned on the product Label for cross reference.
2. The assembly description indicates the max configuration supported for each assembly code.
3. Indicates the part which constraints the temperature range for each code.

**Humidity:** 0-95% Non-Condensing

**Type of Installation:** Out Door Unit

**Altitude:** Less than 2000m

#### Zone 2 Ambient Temperature vs Assembly Code Table

Assembly code (ExACXX) <sup>1</sup>	Ambient Temperature Range (°F)	Ambient Temperature Range (°C)	Assembly Description <sup>2</sup>
ExAC01	-4 to 113	-20 to 45	EVC, Modem, Barrier, and 21Ah SLA Battery
ExAC02	5 to 113	-15 to 45	EVC, Battery, Barrier, and 7Ah SLA Battery
ExAC03	S-4 to 131	-20 to 55	EVC, Modem, and Barrier <sup>3</sup>
ExAC04	-22 to 140	-30 to 60	EVC, RV50/RV50X/RV55 Modem <sup>3</sup>
ExAC05	-40 to 140	-40 to 60	EVC
ExAC06	-14 to 113	-10 to 45	EVC, Modem, Barrier, 21Ah SLA Battery, and AC-DC

1. The assembly code (ACXX) is also mentioned on the product Label for cross reference.
2. The assembly description indicates the max configuration supported for each assembly code.
3. Indicates the part which constraints the temperature range for each code.

### 1.4.6 Temperature Measurement

- Highly stable, solid state temperature sensor (Thermistor)
- Maximum error over the full temperature range  $-40^{\circ}$  to  $70^{\circ}\text{C}$  ( $-40^{\circ}\text{F}$  to  $+158^{\circ}\text{F}$ ) including linearity, repeatability and hysteresis:
  - Temperature:  $\pm 0.1\%$  of reading
- Maximum error at reference conditions:
  - Temperature:  $\pm 0.1\%$  of reading

### 1.4.7 Pressure Measurement

#### Ambient temperature range of Pressure Transducer:

- Maximum error over the full temperature range  $-40^{\circ}$  to  $70^{\circ}\text{C}$  ( $-40^{\circ}\text{F}$  to  $+158^{\circ}\text{F}$ ) including linearity, repeatability and hysteresis:
  - Pressure:  $\pm 0.1\%$  of full scale
- Maximum error at reference conditions:
  - Pressure:  $\pm 0.04\%$  of full scale
- Long term drift:
  - Pressure:  $\pm 0.4\%$  of full scale over 10 years

Maximum pressures per pressure transducer type and range: 6 to 1500psig/30-1500psia

**Note:** For more specification details, please refer [EC350 Datasheet](#).

Type	Pmax	Units
Gauge	6	psig
Gauge	30	psig
Gauge	60	psig
Gauge	100	psig
Gauge	300	psig
Gauge	600	psig
Gauge	1000	psig
Gauge	1500	psig
Absolute	30	psia
Absolute	100	psia
Absolute	300	psia
Absolute	600	psia
Absolute	1000	psia
Absolute	1500	psia

Pressure Expansion (PE) Board for Pressure Transducer, P3:

Existing MIWI350 supports only two pressure connections. An additional Pressure, P3 option is now enabled for additional pressure measurement and to monitor the pressure.

A simple pressure regulator station contains minimum of three pressure taps to monitor under abnormal conditions:

1. Regulator Input
2. Regulator Output and
3. Pressure Alarm (which is now available with P3).

To enable P3, MIWI350 uses Pressure Expansion (PE) Board which allows the customer to connect up to three pressures and monitor the alarms with the third pressure connection.

PE Board is an additional PWA mounted inside MIWI350 casing adjacent to Power Distribution Board and is a complete retro fit to current MIWI350 solution.

Pressure Expansion (PE) Board to Input-Output Board internal wiring connections:

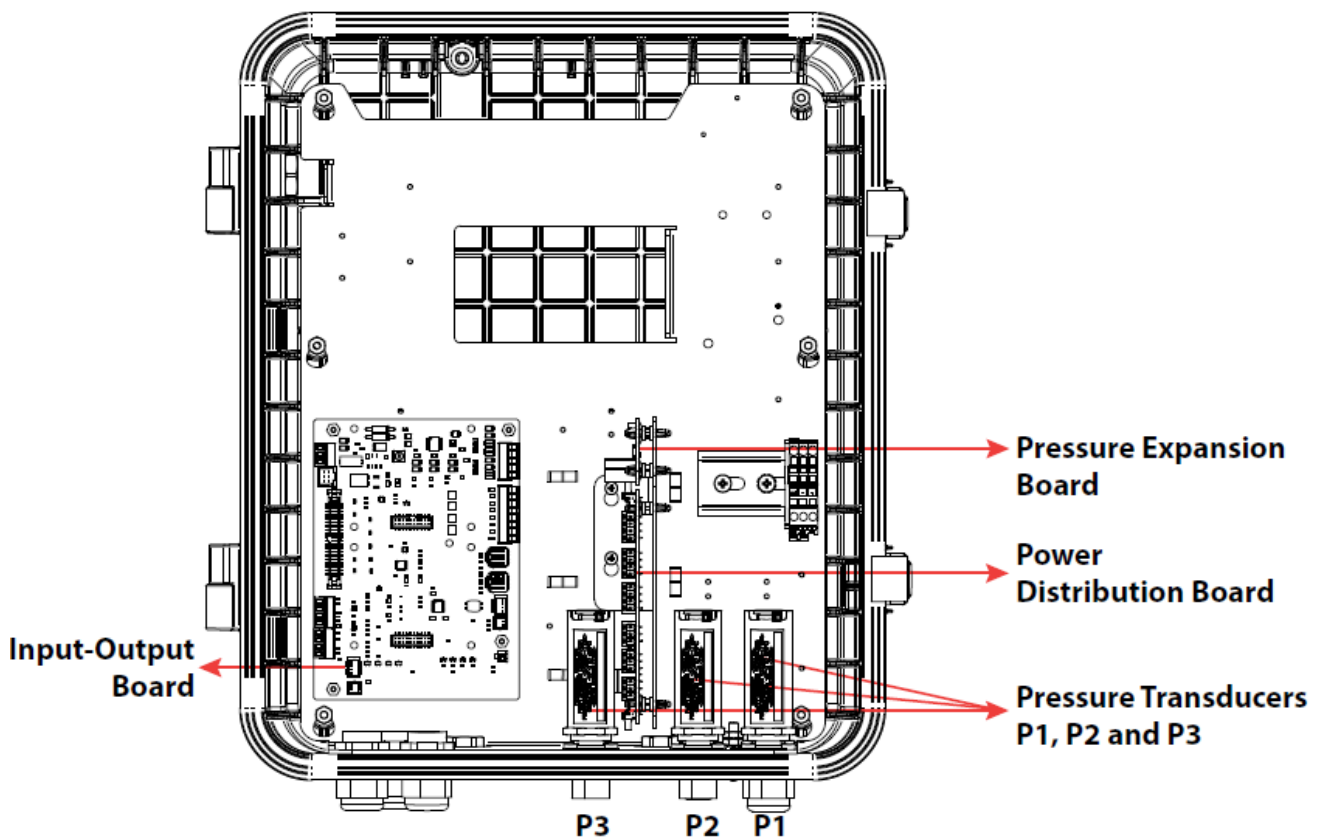

**Note:** Refer Item Reference Guide for Pressure, P3 support and battery related item list.

An additional P4 sensor is now enabled to measure and monitor the pressure.

The **P4** is a virtual sensor. It is configured to all pressure sensors. As configured, it calculates the pressure differences between any two pressure sensors. For example, P1-P2, P1-P3, P2-P1, P2-P3...and so on.

For more information, see *EC350 Users Guide* and *Item Reference Guide*

## 1.5 Safety Measures

### 1.5.1 Safety and Hazardous Information

MIWI350 complies with general safety standards and regulations. However, failure to operate this product as per the safety instructions available in this document may lead to hazards.

It is approved for use in hazardous areas Class I, Division 2\Class1 Zone2. Different versions of MIWI350 are available depending on the operating temperature conditions. The permitted operating conditions are marked on each product. Check the operating condition limits of MIWI350 before installing. You must be familiar and comply with current applicable electrical installation standards and regulations before installing and operating MIWI350 in hazardous areas.

### 1.5.2 Conditions of Acceptability

1. The MIWI350 enclosure shall not be opened in the presence of ignitable concentration of explosive gas atmosphere. Do not connect/disconnect the device unless the power has been switched off or the area is deemed to be non-hazardous.
2. For externally powered configurations, power to this equipment must be supplied by a source that is categorized as “CLASS 2” and “SELV” as specified in the Canadian Electrical Code, C22.1 and the National Electrical Code NFPA 70.
3. Use only Honeywell approved battery/battery packs with this product. Substitution of components will void suitability for Class I Division 2.

**Warning:** Denotes an explosion hazard. Ensure you follow all instructions described in the warning notification.

### 1.5.3 Warning-Explosion Hazard/Avertissement - Risque d'explosion

Do not Open, Disconnect, or Service in an area where an explosive atmosphere may be present. Any service or repair shall be performed by qualified technicians only.

Ne pas ouvrir, déconnecter ou entretenir dans une zone où une atmosphère explosive peut être présente. Toute réparation ou réparation ne doit être effectuée que par des techniciens qualifiés.

Honeywell recommends you to observe the warning information described in this document and other generally applicable safety rules.

- No warranty claims can be asserted if there is an unauthorized interference with the device.
- You can use MIWI350 in hazardous areas, under permitted operating conditions. Ensure to comply with the applicable laws and regulations, and company policies for the usage of MIWI350.

- Installation, commissioning, service, maintenance, and troubleshooting of MIWI350 in hazardous areas must only be done by specially trained and qualified staff.
- Operate MIWI350 only if the instrument is completely intact.

**Warning:** (For mains configuration only) This unit must be isolated or disconnected from the mains supply before opening the enclosure. Cet appareil doit être isolé ou déconnecté de l'alimentation secteur avant d'ouvrir le boîtier (pour la configuration secteur uniquement).

### 1.5.4 Things to Remember

#### 1.5.4.1 Usage of MIWI350 in Hazardous Areas

You may use MIWI350 in hazardous areas, under permitted operating conditions. Ensure to comply with the applicable laws and regulations, and company policies for the usage of MIWI350.

#### 1.5.4.2 Installation and Commissioning of MIWI350 in Hazardous Areas

MIWI350 must be installed and commissioned only by specially trained and qualified staff. The installation of the intrinsically safe circuits must comply with the applicable local laws or regulations. Operate MIWI350 only if the instrument is completely intact. For further details, Refer to 40-6187: MIWI350 Installation drawings.

#### 1.5.4.3 Instructions for Installation in Zone 2 Location as per IECEx Certification

When installing the MIWI350 AC-DC Variant, make sure to perform the below steps:

1. Ensure the equipment shall install as per IEC 60079-14 standard.
2. At the equipment's supply terminals, transient protection shall be provided at a level not exceeding 140% of the peak rated voltage value.

#### 1.5.4.4 Service, Maintenance, and Troubleshooting

The service, maintenance and troubleshooting of MIWI350 device operating in hazardous areas must be performed only by specially trained and qualified staff.

MIWI350 contains no user replaceable part except the approved battery Packs.

##### Replacement of battery pack

To maintain acceptability of use in hazardous locations, only use replacement battery packs supplied by Honeywell.

**Honeywell approved battery packs are:**

Sl No.	Battery Pack	Honeywell Part Number
1	Alkaline Dual Pack	22-2770-3-KIT
2	Alkaline Quad Pack	22-2770-3-KIT X 2
3	SLA Battery 21Ah	40-6180-KIT

4	SLA Battery 7Ah	40-2321-KIT
5	Backup Battery	40-6064-KIT

Fuse rating of the SLA battery 5A, 32V

**Make:** Bussman

**Part No.:** 5ATC

**Caution:** Alkaline dual and quad packs are not approved for zone 2 installations " DO NOT USE THIS ALKALINE KITS FOR ZONE 2 LOCATIONS"

## 2 Security Control Measures

Security control recommendations are provided hereby to avoid unauthorized external access that may result in the following:

- Loss of system availability.
- Incorrect execution of controls causing damage to the plant, or theft or contamination of the product.
- The capture, modification, or deletion and loss of data.

**Caution:** The caution warns you of possible damage to property and provides instructions to avoid damage to MIWI350.

### Recommendations:

- Use a state full firewall at the business network to restrict access from the business network to process control network.
- Logically segment process control system networks into multiple segments (such as control network, supervisory network, non-control system network, business network). Take steps to implement and enforce physical security of devices in network.
- Logically and physically isolate control system networks from non-control system networks. The network devices (e.g. switches, routers, firewalls) along with necessary access control and routing policy can be used to logically isolate, prioritize the different network segment and/or application traffic.
- Prohibit or restrict unnecessary network traffic into control system networks from non-control system network and vice versa.
- Secure the communication through private VPN IPsec tunnel from the device/cellular network to the remote MDM host.
- Use physical security for process control network systems. Take steps to implement and enforce physical security of devices in network.
- Do not allow the use of unauthorized removable media near to the device installation.
- Use strong passwords on network equipment.
- Prevent the use of unauthorized laptops on the process control network.
- Ensure safe storage of installation media, license keys, and configuration information.
- The device must be physically protected in locked cabinets, and logically protected with passwords to prevent tampering
- Secure the local LAN link from VPN gateway to host application within the premises
- The host machine and software should be protected by anti virus and Operating system patches.
- Restrict physical access to the device. Avoid access to local interfaces (RS232, Ethernet and USB interfaces) of MODEM.
- Avoid using default credentials for cellular MODEM access. The user is strongly advised to change the default password for device access. Also, the user is strongly advised to periodically change the password of the device as per respective organization policies.
- Activate only required ports.

Apply ZoneProtection profiles to provide protection against entire zones from flood attacks and DoS protection. This provides granular defense for specific systems, especially critical systems



## 2 Security Control Measures

that users access from the internet and often attack targets, such as web servers and database servers. Apply both types of protection.

- Refer CloudLink ([R100](#) and [R110](#)) manuals for security features in CloudLink MODEM and refer [RV50](#) and [RV50X](#) and RV55 data sheets for RV50/RV50X/RV55.
- Report security issues or vulnerabilities at [MI-TAC-Support@Honeywell.com](mailto:MI-TAC-Support@Honeywell.com) for us to quickly respond.
- The RV50x/RV55 unique Password to access ALMS (AirLink Management Service) for each device will be provided along with the Product test Report document shipped with each device.

### ROLES:

System Operator	Role allows a user to login into the device and collect application data
Field Technician	Role allows a user to login into the device, configure, calibrate, collect application data and test for proper operation.

### MIWI350 deployments with CloudLink R100/R110:

The user is recommended to deploy the device and Remote MDM server application under secured VPN network.

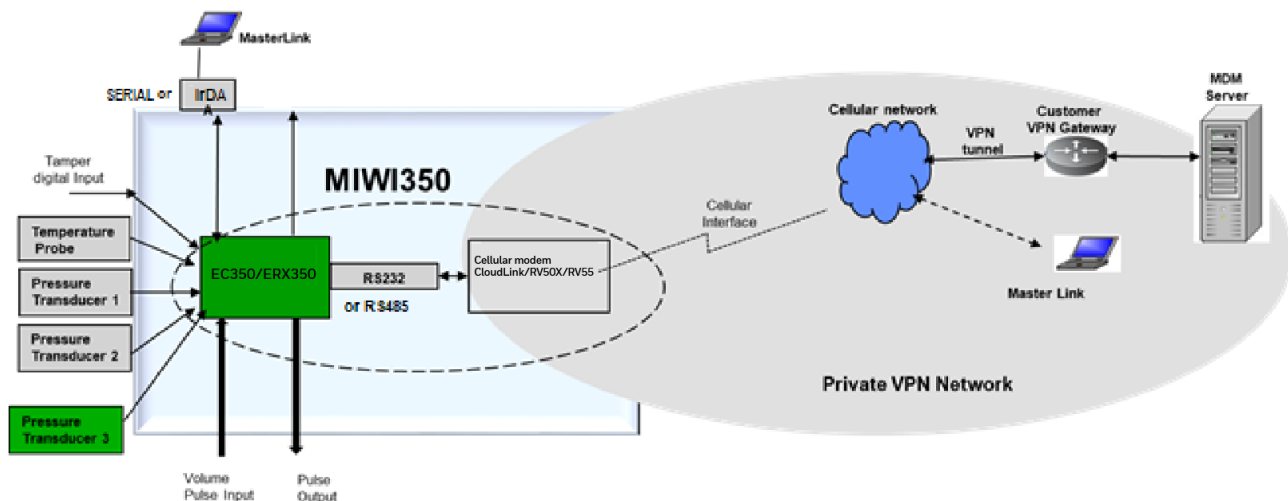

- Restrict physical access to the device and other network devices in the network.
- Secure the connection between the Cellular carrier network and end gateway by VPN tunnel.
- Secure the LAN connecting Customer/User VPN gateway and the MDM server running the MDM application.
- Use a firewall for the business network to process control/monitor network interface to restrict access to the business network to process control network.
- Use a firewall within local area network connecting VPN Gateway to server hosting MDM application.
- Close all unused TCP and UDP communication ports on server hosting MDM application.
- Set the minimum level of privilege for all accounts, and enforce a strong password policy.
- Do not allow the use of unauthorized removable media.
- Prevent the use of unauthorized laptops on the process control network.
- Use and enforce a strong password policy.

## 2 Security Control Measures

---

- User is recommended to use remote host whitelisting on CloudLink (Configure up to 10 host IP addresses of remote hosts that will be allowed to communicate with the device in case of call outs from remote host to the device).
- The user is advised to use passkey entry mechanism for BLE communication.
- Ensure that your virus protection and Microsoft security hot fixes are up to date on all systems.

## 3 Installation

### 3.1 Unpacking

After you receive the MIWI350 package:

1. Remove the contents from the box and the mounting kit bag.
2. Check the shipment against the order to ensure that the components ordered are installed in MIWI350.
3. Report any shortage or shipping damages to your Honeywell Account Manager immediately.

### 3.2 Mounting Options

The MIWI350 device can be installed in the field using the following mounting options:

#### Meter or UMB Mount



#### Wall Mount



**Note:** Recommended Brick Wall Fasteners - Stainless Steel Thread Forming ¼" dia-2.0" length, Screw size 0.25" Min Torque 56 lb-in.

Pipe Mount - U-Bolt 2" 3" and 4"

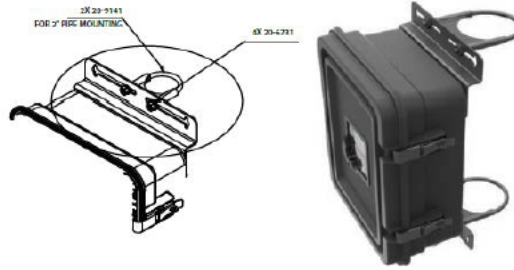

3.2.1 Device Marking

  
**MERCURY INSTRUMENTS**  
**MODEL MIW350**  
 GAS VOLUME CORRECTOR

CLASS I, DIV 2 GROUPS C & D; T3C  
 WHEN INSTALLED AS PER DRAWING 40-6187

RATINGS: **#TEXT 1**  
 ASSEMBLY CODE: **#TEXT 2**

USE ONLY MERCURY INSTRUMENTS BATTERY PACKS AS  
 PER INSTALLATION DRAWING 40-6187

DIV 2 WARNINGS: EXPLOSION HAZARD  
 DO NOT OPEN, DISCONNECT OR SERVICE IN AN AREA  
 WHERE AN EXPLOSIVE ATMOSPHERE MAY BE PRESENT.  
 ANY SERVICE OR REPAIR SHALL BE PERFORMED BY  
 QUALIFIED TECHNICIANS ONLY.

DIV 2 AVERTISSEMENT: RISQUE D'EXPLOSION  
 NE PAS OUVRIR, DÉBRANCHER OU RÉPARER DANS UNE  
 ZONE OÙ UNE ATMOSPHÈRE EXPLOSIVE PEUT ÊTRE  
 PRÉSENTE. TOUTE RÉPARATION OU RÉPARATION NE DOIT  
 ÊTRE EFFECTUÉE QUE PAR DES TECHNICIENS QUALIFIÉS.

CAUTION  
 REFER TO USER MANUAL FOR DETAILED OPERATING  
 TEMPERATURE SPECIFICATION AND MODEM POWER INPUT  
 SPECIFICATIONS

MERCURY INSTRUMENTS INCORPORATED  
 512 VIRGINIA DRIVE  
 FORT WASHINGTON, PENNSYLVANIA, 19034  
 UNITED STATES **#TEXT 3**

**MERCURY INSTRUMENTS**  
**MODEL MIW350**  
 GAS VOLUME CORRECTOR



Ex ec IIC T4 Gc  
 IECEx SIR 21.0000X  
 WHEN INSTALLED AS PER DRAWING 40-6187

RATINGS: **#TEXT 1**  
 ASSEMBLY CODE: **#TEXT 2**

USE ONLY MERCURY INSTRUMENTS BATTERY PACKS AS  
 PER INSTALLATION DRAWING 40-6187

ZONE 2 WARNINGS: EXPLOSION HAZARD  
 DO NOT OPEN, DISCONNECT OR SERVICE IN AN AREA  
 WHERE AN EXPLOSIVE ATMOSPHERE MAY BE PRESENT.  
 ANY SERVICE OR REPAIR SHALL BE PERFORMED BY  
 QUALIFIED TECHNICIANS ONLY.

ZONE 2 AVERTISSEMENT: RISQUE D'EXPLOSION  
 NE PAS OUVRIR, DÉBRANCHER OU RÉPARER DANS UNE  
 ZONE OÙ UNE ATMOSPHÈRE EXPLOSIVE PEUT ÊTRE  
 PRÉSENTE. TOUTE RÉPARATION OU RÉPARATION NE DOIT  
 ÊTRE EFFECTUÉE QUE PAR DES TECHNICIENS QUALIFIÉS.

CAUTION  
 REFER TO USER MANUAL FOR DETAILED OPERATING  
 TEMPERATURE SPECIFICATION AND MODEM POWER INPUT  
 SPECIFICATIONS

MERCURY INSTRUMENTS INCORPORATED  
 512 VIRGINIA DRIVE  
 FORT WASHINGTON, PENNSYLVANIA, 19034  
 UNITED STATES

**TEXT 3**

### 3.3 Zone2 installation

The MIWI350 Zone 2 can be installed using the following steps

Step-1: Engage the door latches of the device one at a time and then close the device door.



Step-2: Install EX Protection top (22-3188) & EX Protection bottom (22-3189) brackets on MIWI350 device with two M4 screws (60-5074) for each bracket.

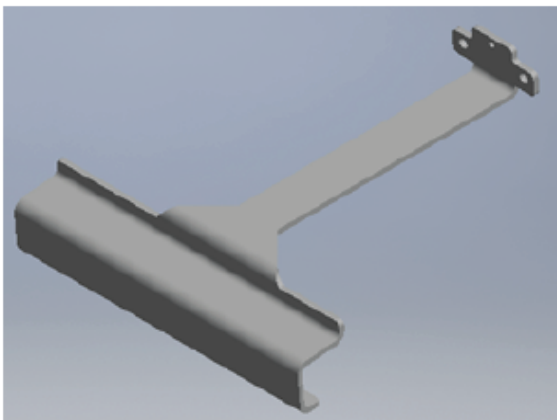

EX-Protection Top bracket (22-3188)

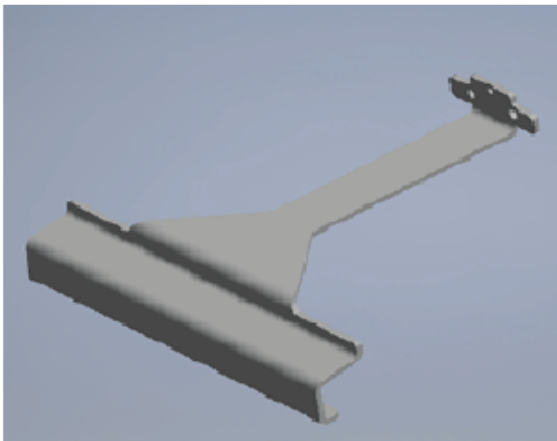

EX-Protection Bottom bracket (22-3189)

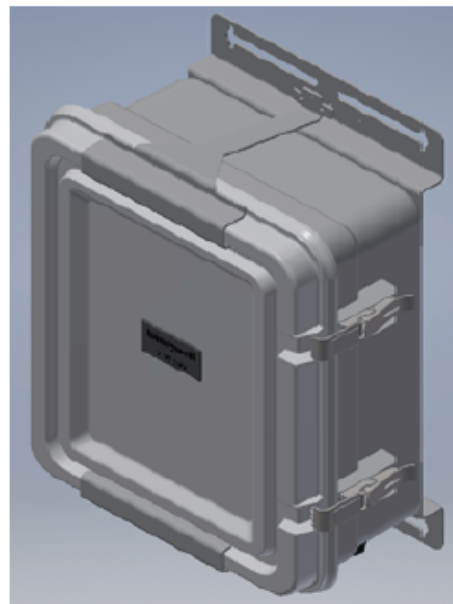

EX-Certified Enclosure (22-3190)



**Note:** Apply 5 to 6 in-lb. torque to M4 screw (60-5074).

Step-4: Make sure that door is compressed properly with the gasket across the borderline by checking the Case & Door mating surfaces.

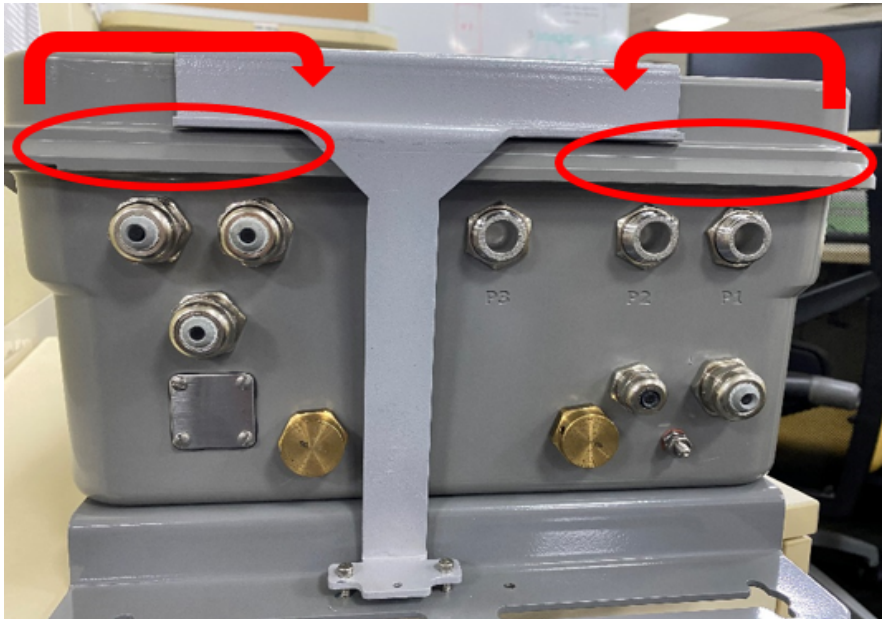

**Warning:** Ensure to install in a Non-Hazardous environment only.

## 4 Mechanical Assembly and User Interface

The MIWI350 device assembly includes:

- Door that includes internal or external display, and without display (MIWI PCB).
- Case that holds Batteries, Power Supply, Antenna, Power Distribution Board, Pressure Transducers, Solar Charge Controller, Temperature Probe Assembly, Barriers, Terminal Blocks, Cable glands, super capacitor and a MODEM.

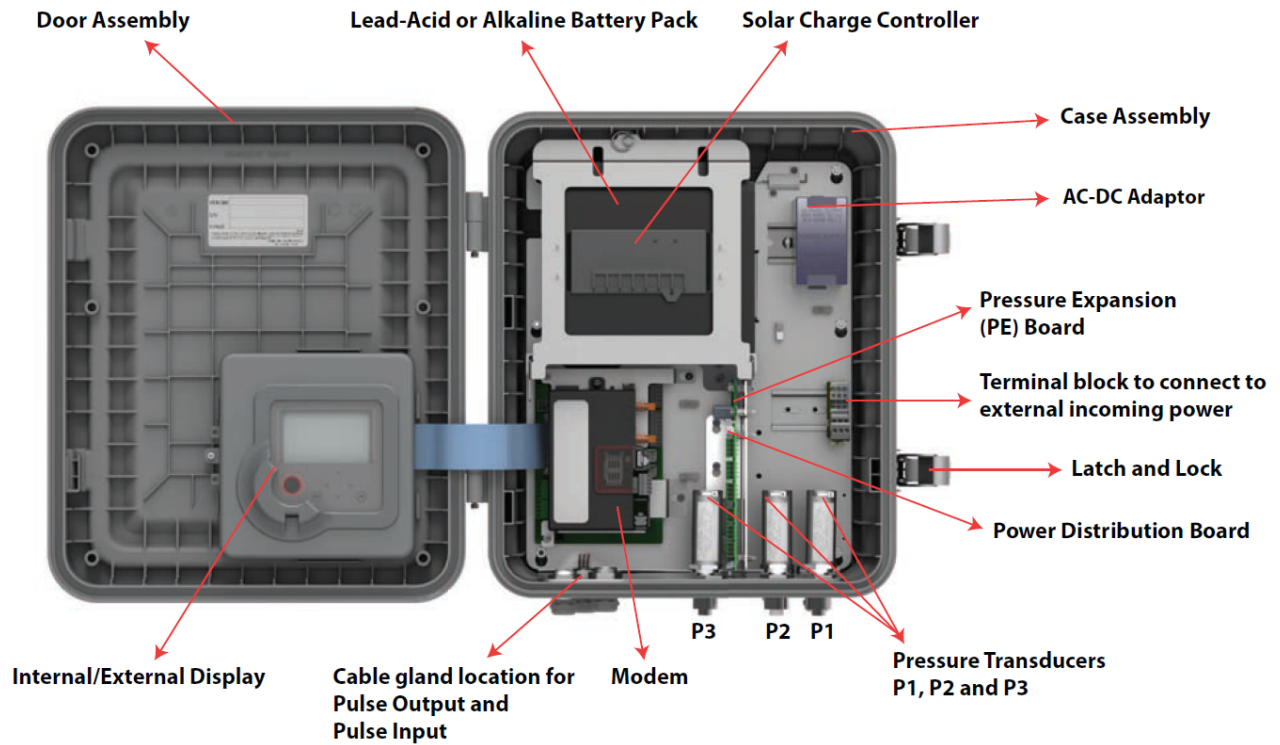

Figure 4-1: MIWI350 Mechanical Assembly

**Note:** Based on MSG configuration, these sub-assemblies may vary.

## 4.1 Device Dimensions & Weights

The images below provide dimensions of MIWI350 devices (all dimensions are in inches.)

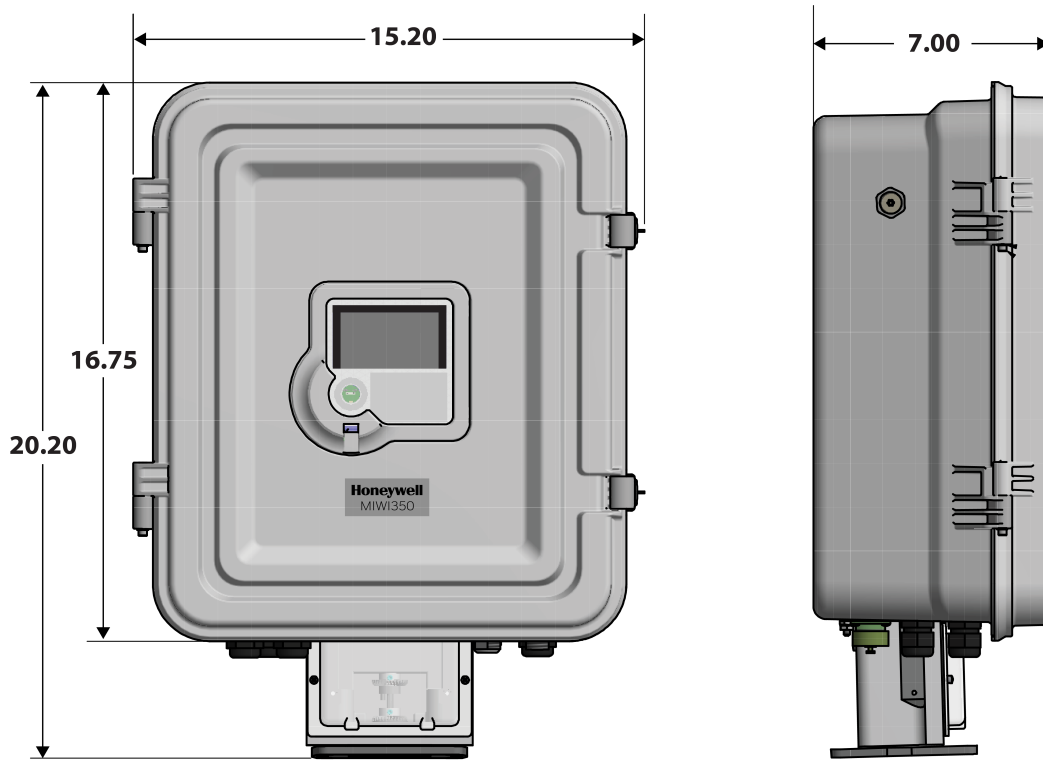

Figure 4-2: Meter Mount (20 lbs\* approx.)

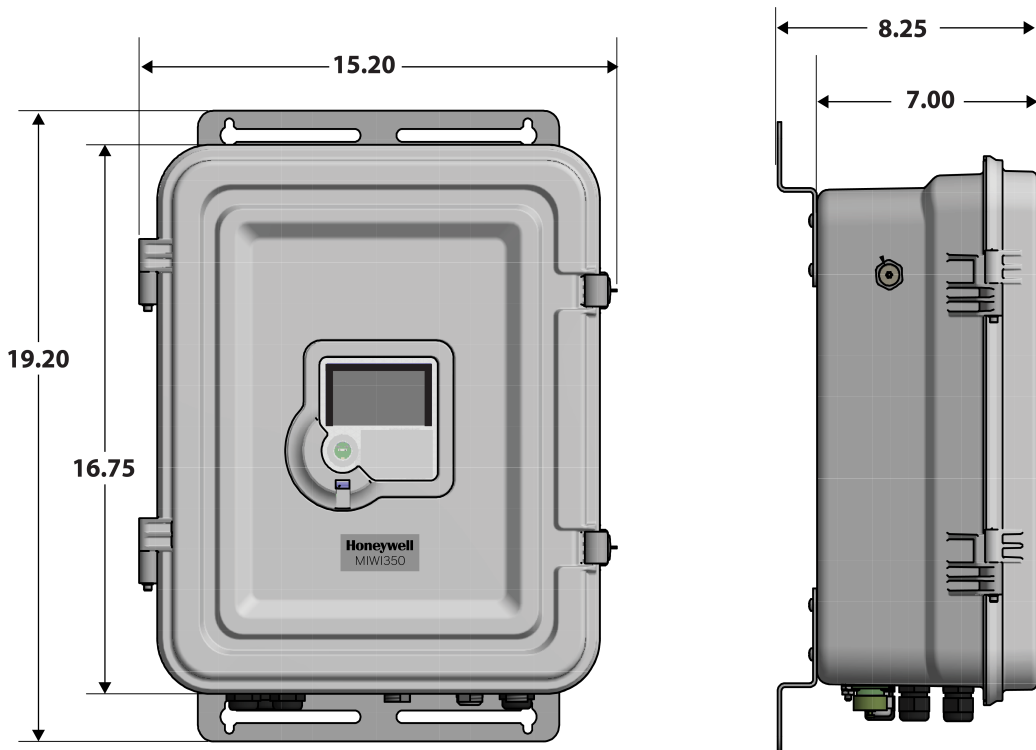

Figure 4-3: Remote (Wall/U-Bolt) Mount (23 lbs\* approx.)



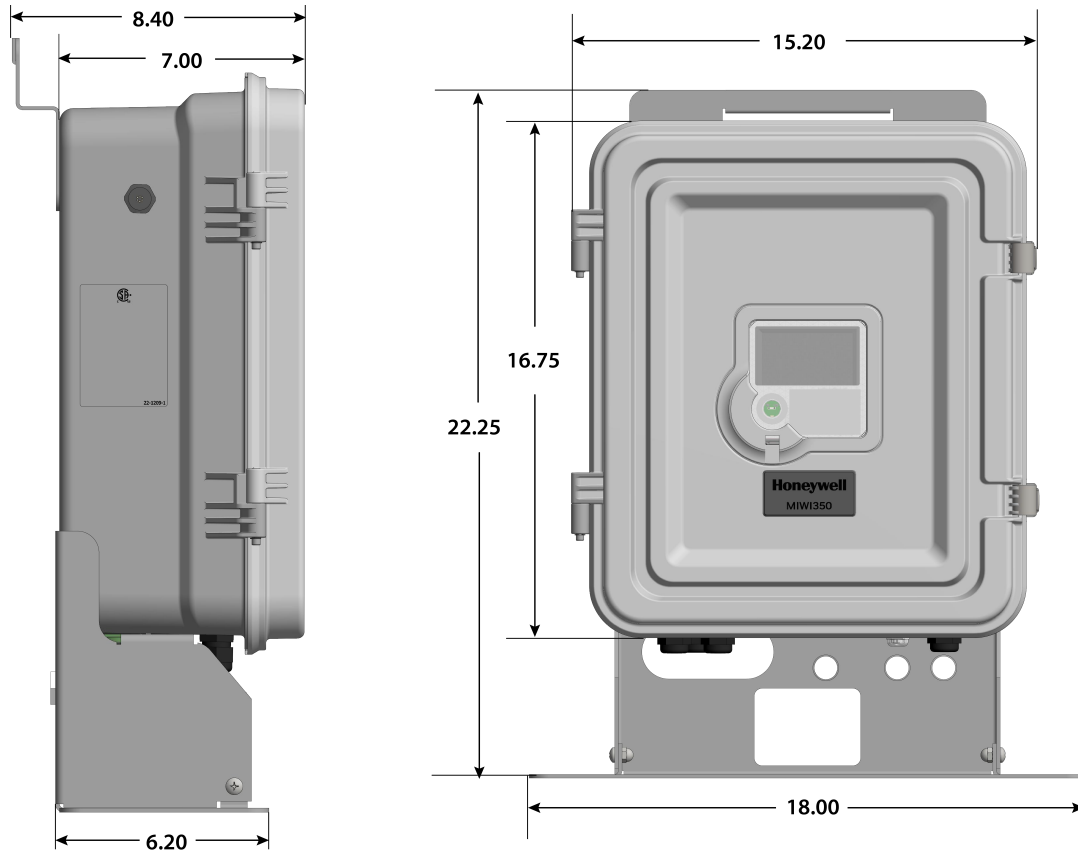

Figure 4-4: Remote Portable Mount (25 lbs\* approx.)

**Note:** \* Device weights may vary depending on the configuration selected.

## 4.2 Display Options

The MIWI350 device is available with two display options - External and Internal. power or Communication Box variants are available without the display option.

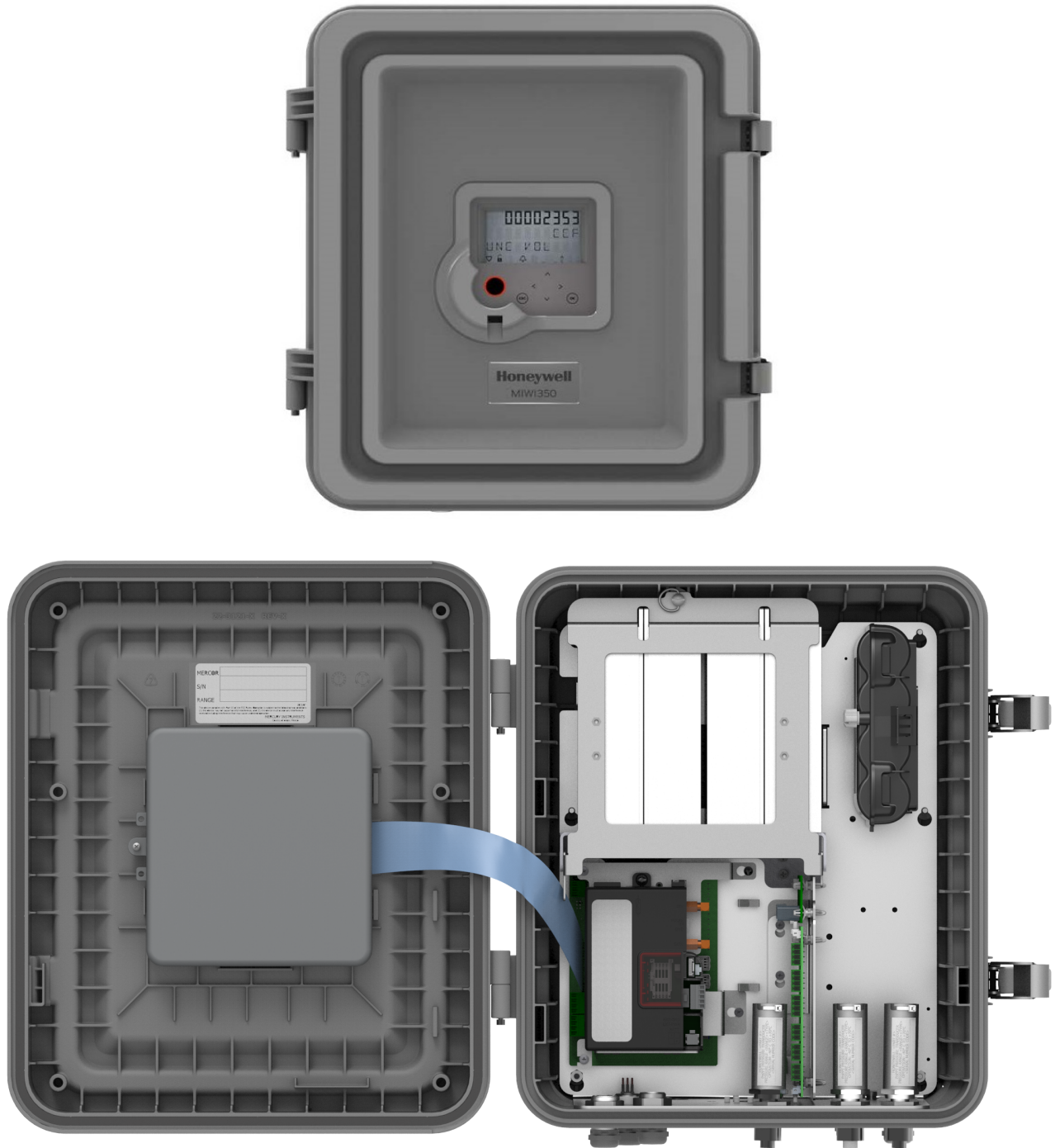

Figure 4-5: MIWI350 with External Display

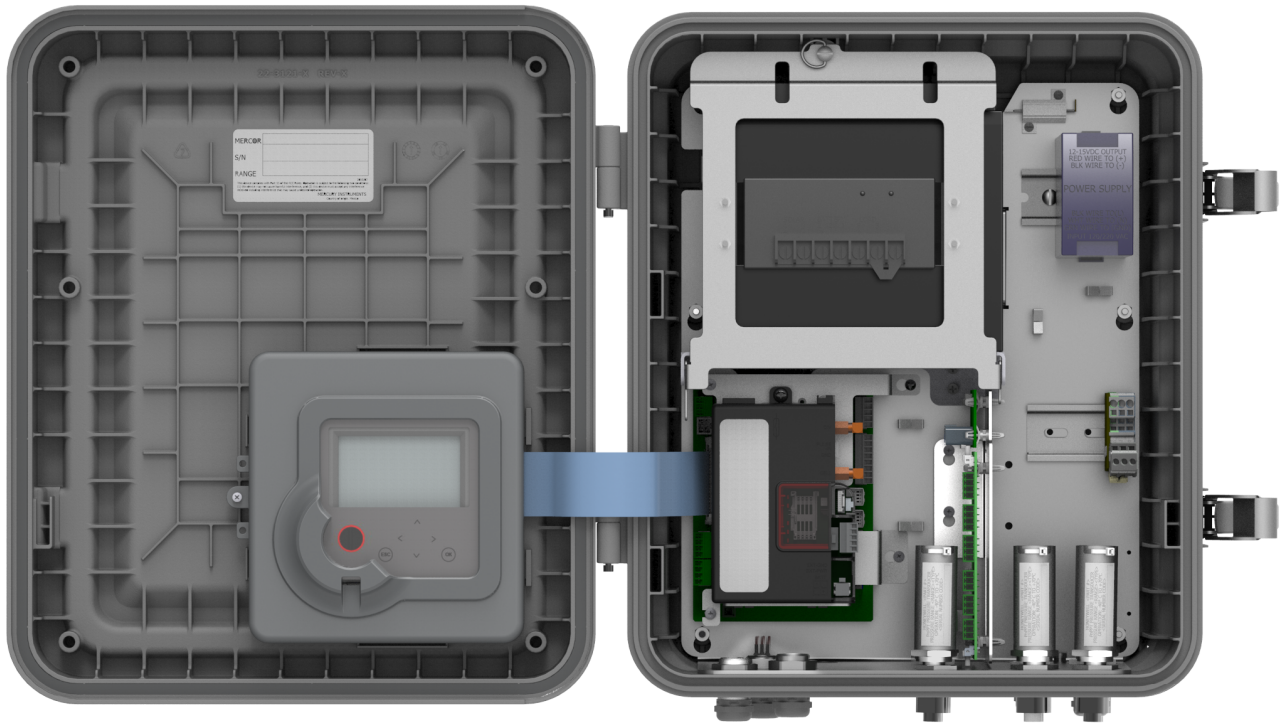

Figure 4-6: MIWI350 with Internal Display

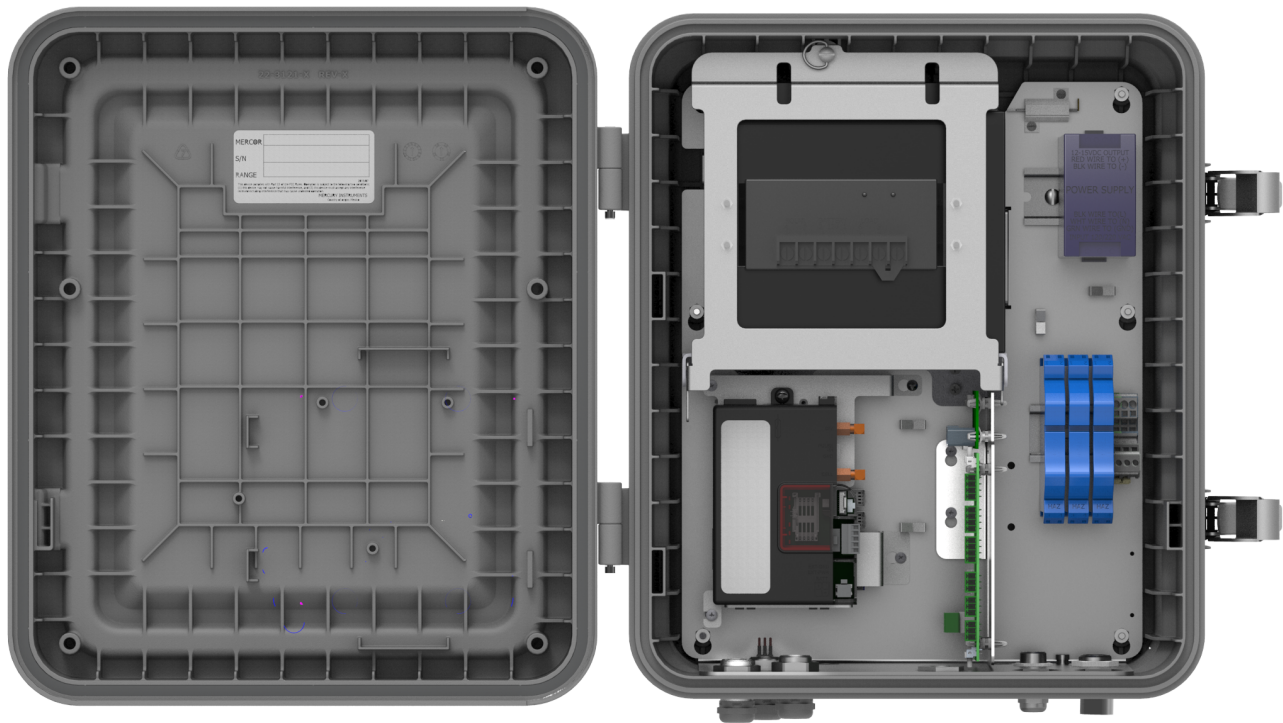

Figure 4-7: MIWI350 Power and Communication Box

#### 4.2.1 HMI User Interface

MIWI350 device includes 3 rows of ten characters, configurable, alphanumeric LCD display with a row of icons to display system and alarm status. The LCD display can be configured to ON or OFF at different times of day. Following is an LCD display illustration, showing all segments ON.

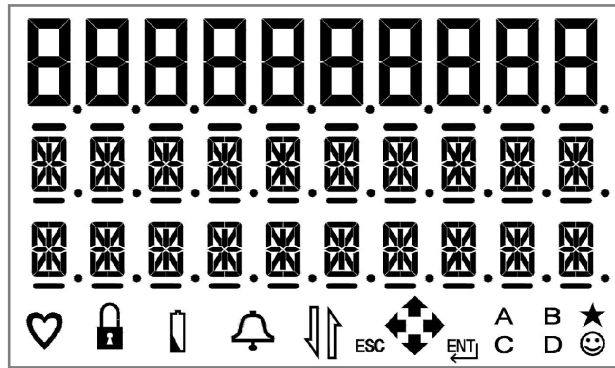























Figure 4-8: LCD display

	<b>Heart Beat:</b> flashes to indicate normal operation.
	<b>Lock/Unlock:</b> indicates whether the unit is metrologically sealed or not.
	<b>Battery:</b> indicates a low voltage condition.
	<b>Alarm:</b> indicates an alarm condition (e.g. high pressure).
	<b>Comm:</b> indicates that the IrDA circuit is enabled.
	<b>Navigation key function indicator:</b> indicates the keys that are available for use during HMI navigation.
	<b>Output channel indicator:</b> indicates enabled pulse output channels and pulse activity.
	<b>Smile:</b> indicates the HMI is unlocked and the navigation keys are functional.
	<b>Star:</b> The Star indicates real-time occurrence of pressure and temperature measurement samples.

Option	Description
 and 	Unlock the keypad and activate the display. To unlock the keypad, press <b>ESC</b> and hold  at the same time until display test appears. Display Test (all segments ON at the same time).
 or 	Scroll up and down in a menu or increase and decrease a value at the current position.
 and 	Navigate to the next and/or previous digit. Move the cursor one character at a time, in forward or backward directions.
	Access the main menu or display the sub menu of the current menu. It is also used for accepting an input value.

Option	Description
	Display the Home screen, cancel an entry, or go back to the previous menu.

**Principles of menu navigation**

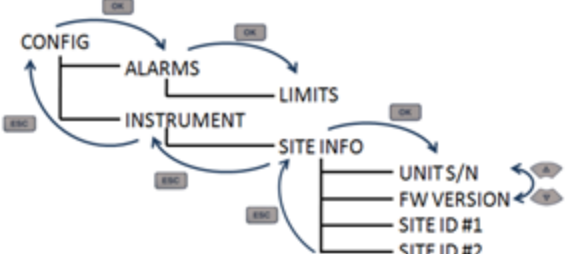
<ul style="list-style-type: none"> <li>- The menu is organized in a tree format.</li> <li>- Use  to drill down one level.</li> <li>- Use  to go up one level.</li> <li>- Use  or  to navigate within the elements of the same subgroup.</li> </ul>	 <p>L2.4 L2.4.1 L2.4.1.1 L2.4.2 L2.4.2.1 L2.4.2.1.1 L2.4.2.1.2 L2.4.2.1.3 L2.4.2.1.4</p>
--	--

Refer to the [Honeywell EC350 User's Manual](#) for more information on using the HMI User Interface.

### 4.3 Gland Entries

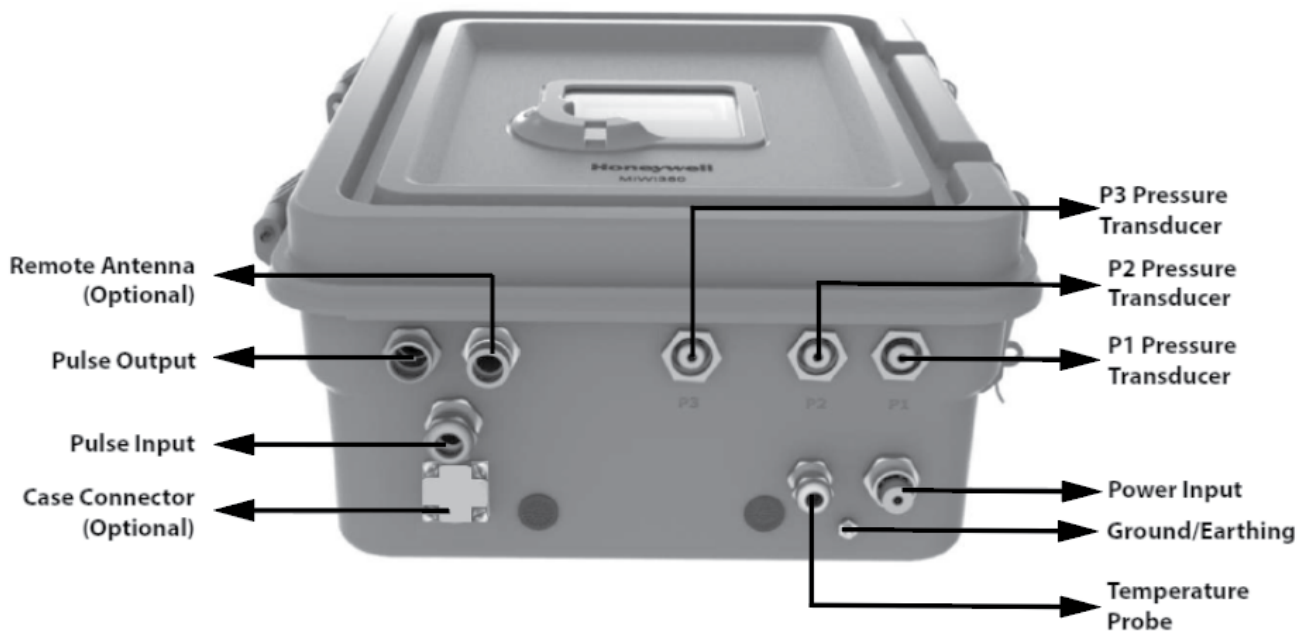
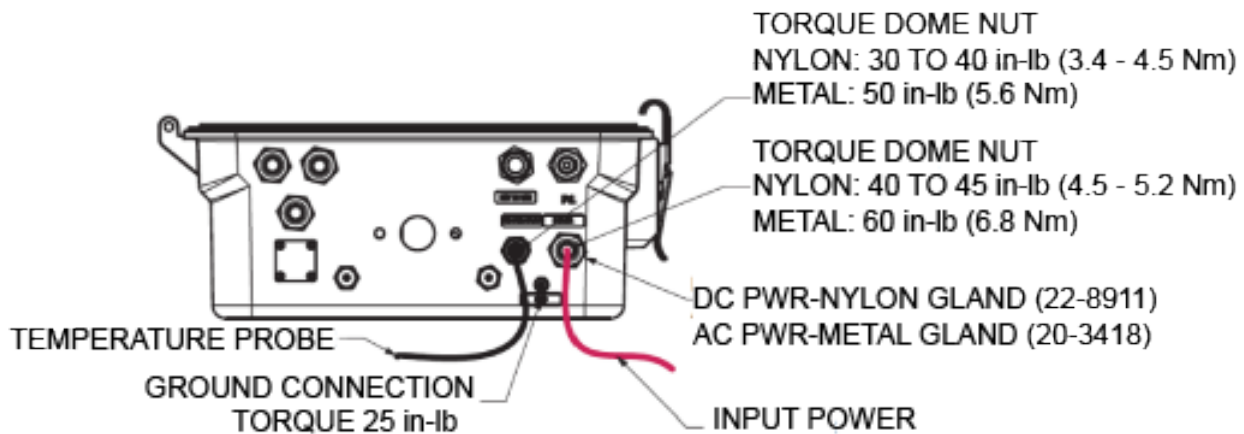

Figure 4-9: Gland Entries

**Note:** The cable glands may not provide sufficient clamping and that the user shall provide additional clamping of the cable to ensure that pulling and twisting is not transmitted to the terminations.

#### 4.3.1 Power Input

The External AC/Solar/DC input supply (as per MSG) should be provided to MIWI350 through this cable gland only. For AC variant a metal conduit will replace the plastic



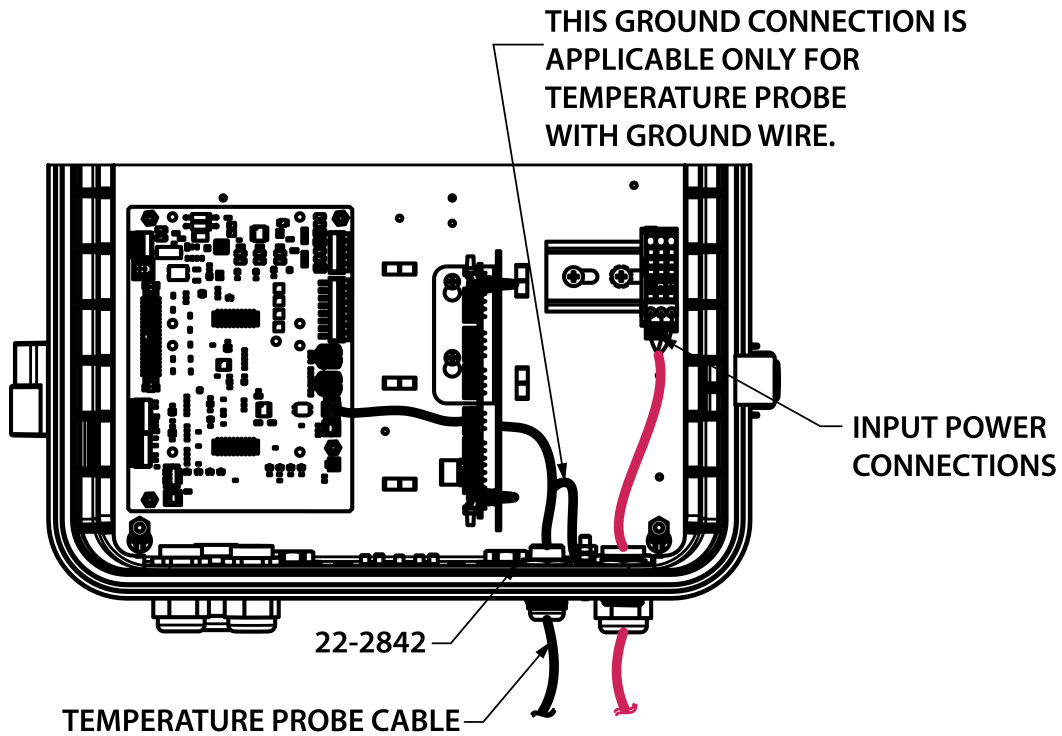
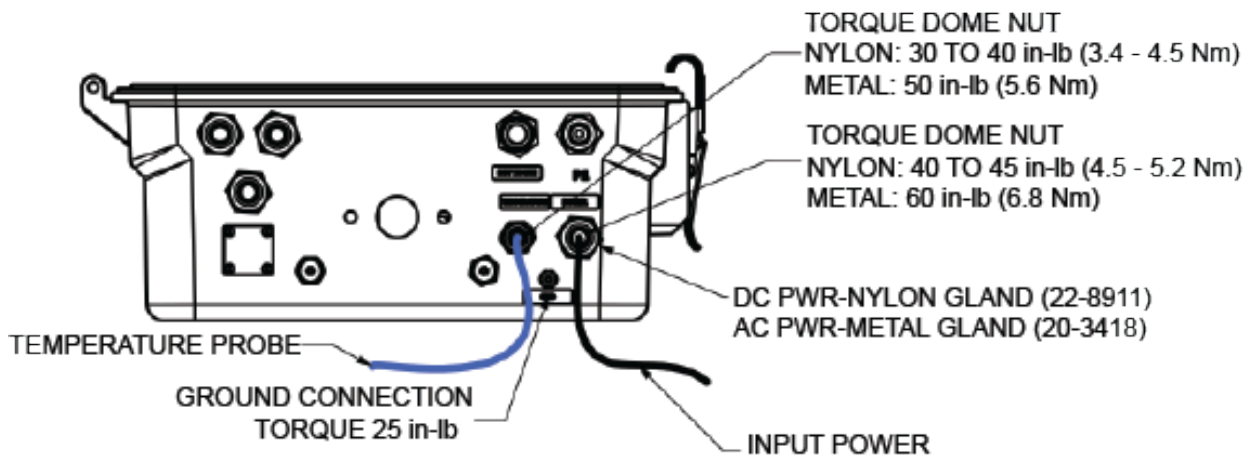

Figure 4-10: Power Input

### 4.3.2 Temperature Input

The Honeywell approved Temperature probes (as per MSG) should be provided to MIWI350 through this cable gland only.



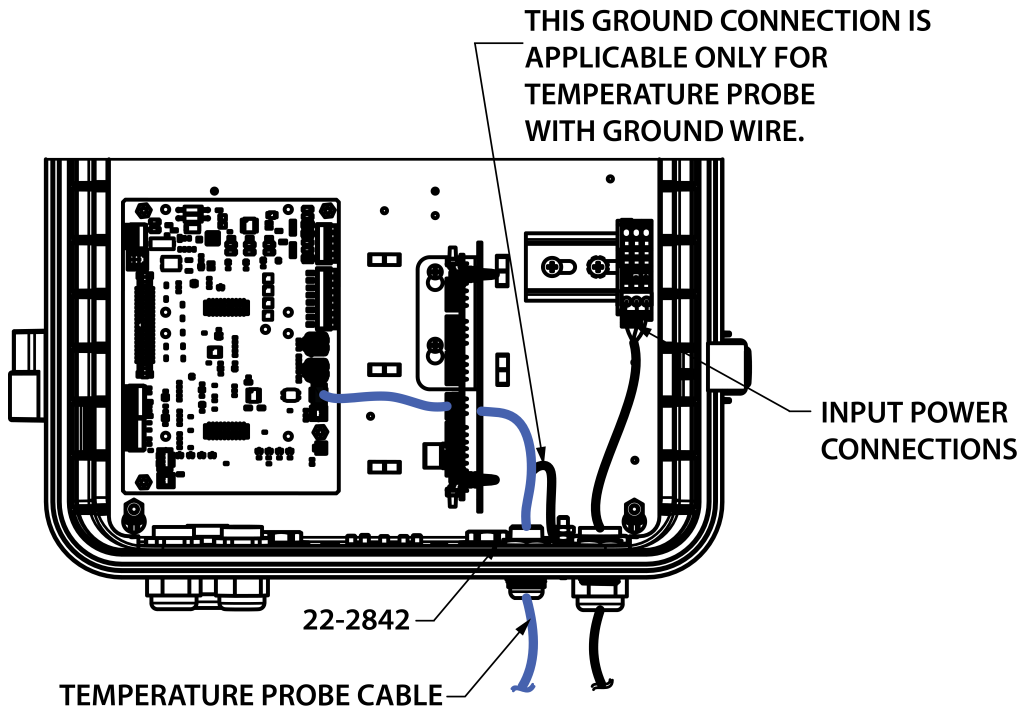

Figure 4-11: Temperature Input

GLAND	DESCRIPTION
Pulse Input	The UMB/Remote pulse inputs (as per MSG) should be provided to MIWI350 through this cable gland only.
Pulse Output	To utilize the 3x Pulse output & 1x Alarm output , the wiring has to be done and cables should be routed through this cable gland only.
Remote Antenna (Optional)	Honeywell approved remote antenna cable for MIWI350 Modem should be provided through this N-Type RF Connector. The MIWI350 comes along with the RF connector when this remote antenna option is selected in MSG.
Case Connector (Optional)	The MIWI350 Power/communication variants has support for case connector to provide the modem serial communication interface. MIWI350 will come with case connector when this option is selected in MSG

**Instruction for Grounding:**

The ground terminal shall be connected to an earth-ground using 12AWG or higher wire gauge and the insulation shall have flammability rating of UL94 V-2 or better. The color code and wiring shall be done as per the rule by the National Electrical Code.

**Caution:** 2X Breather (Bottom) & 1X Breather (Side) vents provided to allow the air passage for pressure equalization, prevent moisture intrusion and protect the device from ingress. Should neither be closed nor used for any cable routing purposes.



# 5 Electrical Assembly

## 5.1 Input or output board

The Input/output board (IO board) lets user to utilize the below mentioned features and interface them

2 Pressure (Optional 3rd Pressure)

1 Temperature

3 Pulse, 1 Alarm Output

4 Digital Inputs

1 RS232/485

1 Tamper Input

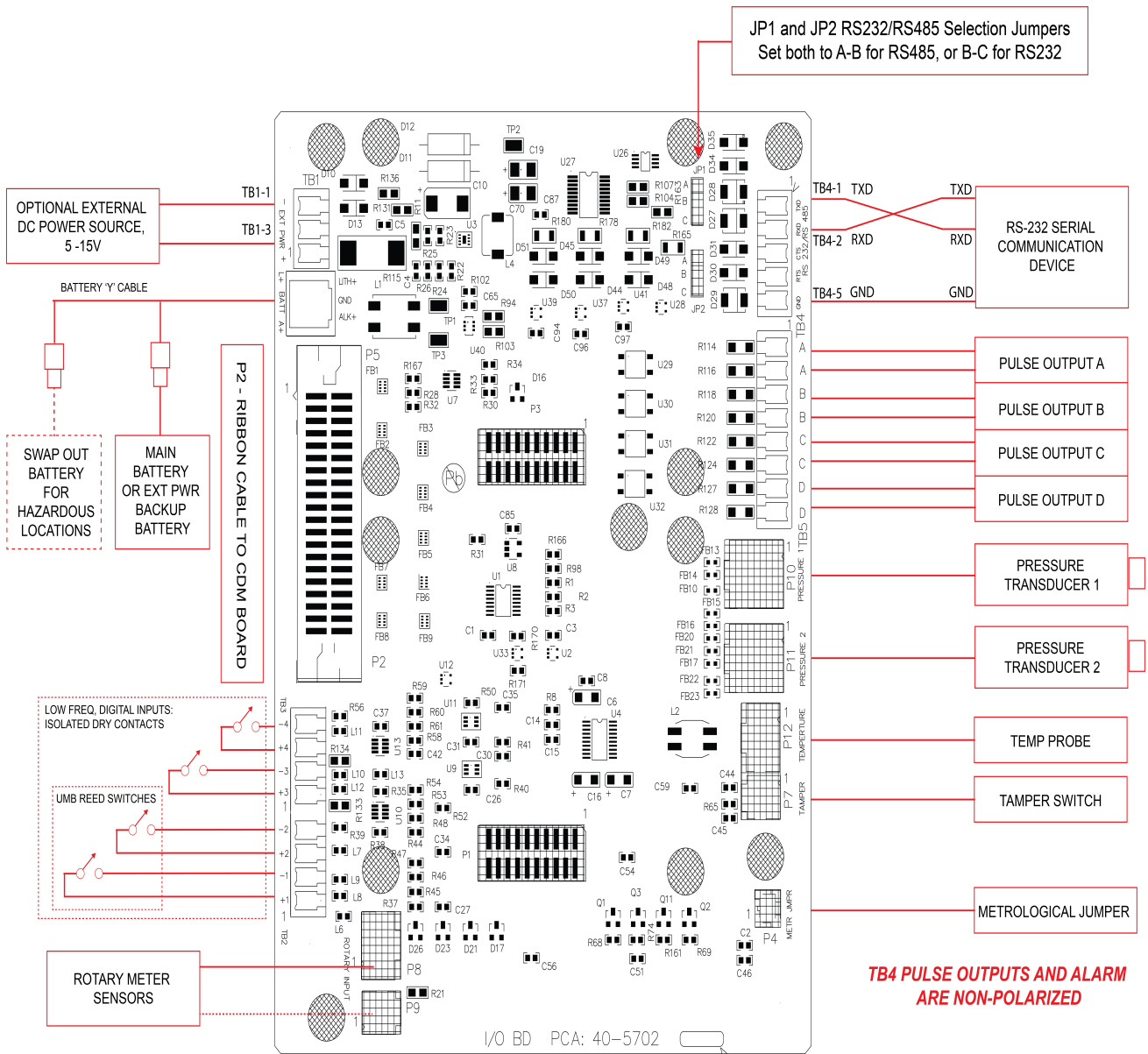

Figure 5-1: Input/Output Board or EVC Board

## 5.2 Power Distribution Board

The primary purpose of the Power Distribution board is to provide primary power (7.5 to 24V DC @1Amp/Hr) and to distribute power out to various communication modules & gas measurement products. The communication modules will likely be a CloudLink, RV50 or RV50X or RV55 cellular MODEM. The gas measurement products will be the 350- series products (configured as either EC350 electronic volume corrector or ER350 pressure recorder) or legacy products, such as; Mini-Max, Mini-AT, ERX, etc.

The secondary purpose of the PD board is to switch MODEM power On or Off, based on a time-schedule or on-demand call-in activity.

Refer [Figure 5-2](#) for more information.

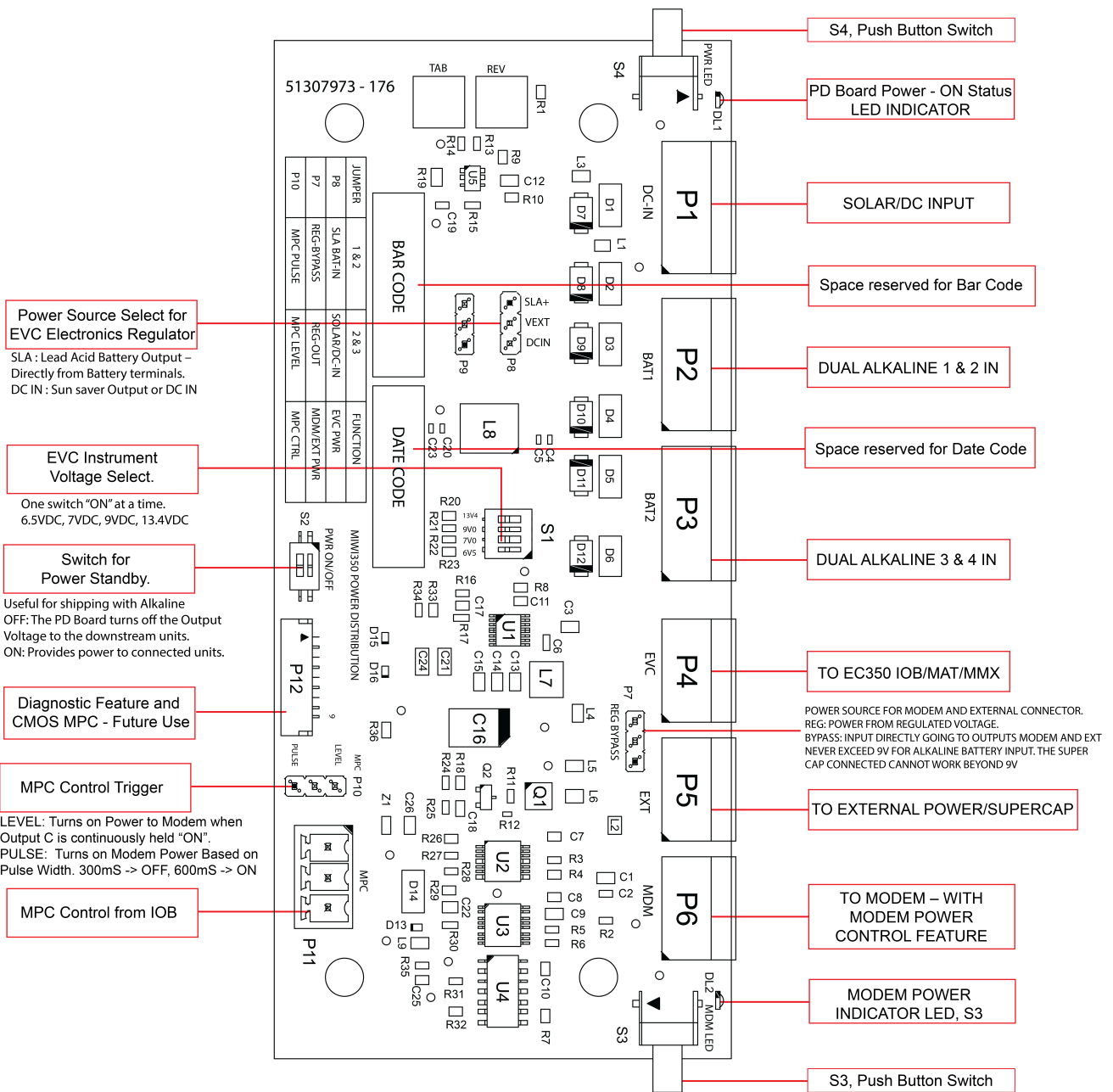

Figure 5-2: Power Distribution Board

**LED switches:**

Push button switch "S3" and "S4" provides visual status of incoming and outgoing power via Red & Green LEDs. To conserve battery power, the LEDs are not operational until the user presses and holds down on each push button switch.

S3 - An LED (located to the right of connector P6) glows bright Red when the Power Distribution board is providing MODEM power but only when the S3 momentary push button is held closed.

S4 - An LED (located to the left of connector P1) glows bright Green when input power to the Power Distribution board is present but only when the S4 momentary push button is held closed.

### 5.2.1 Power Distribution Board connections for Solar-Input/AC-DC input with lead acid battery back up

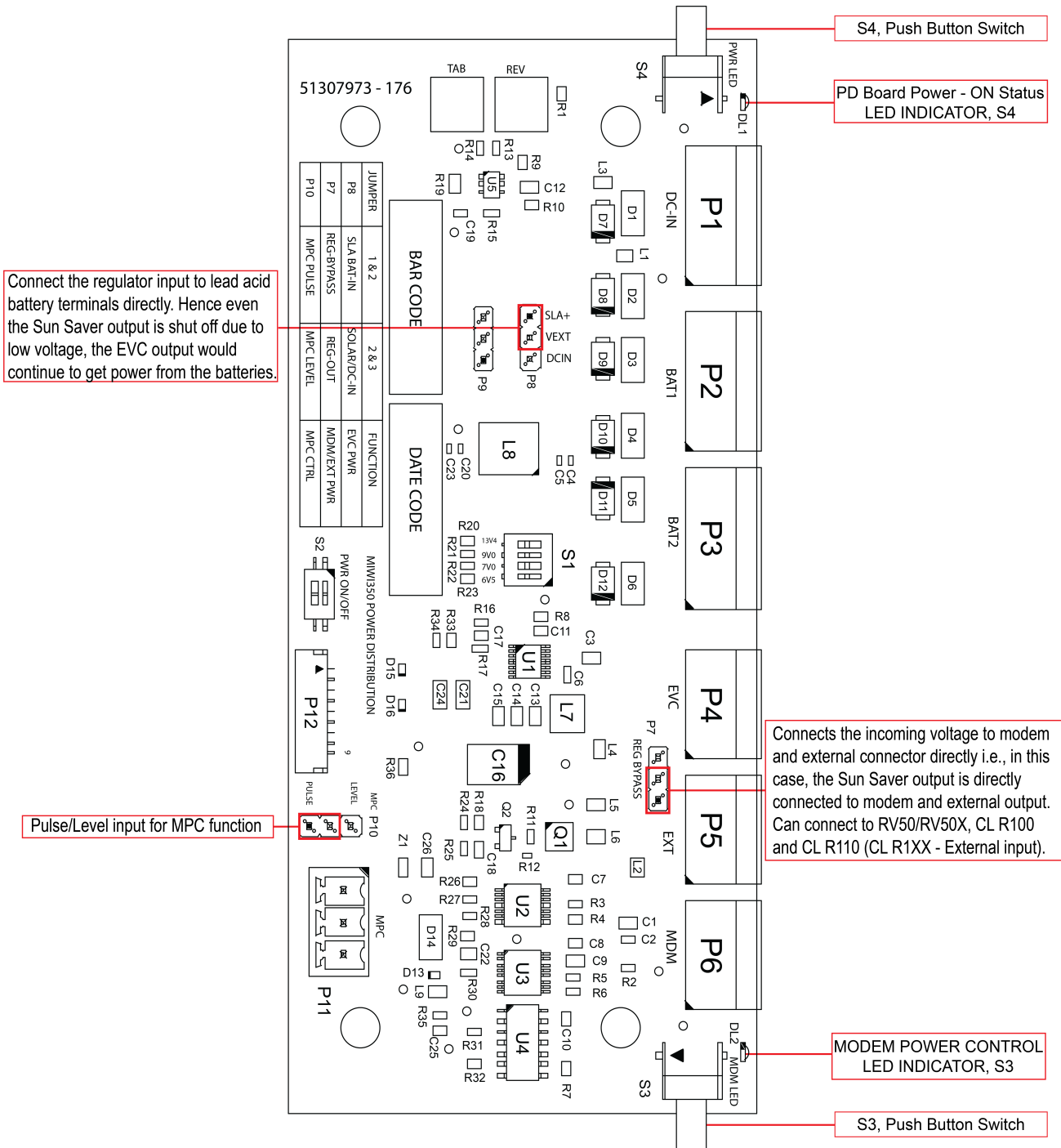

Figure 5-3: Power Distribution Board

5.2.2 Power Distribution Board jumper settings for Alkaline Battery or DC input

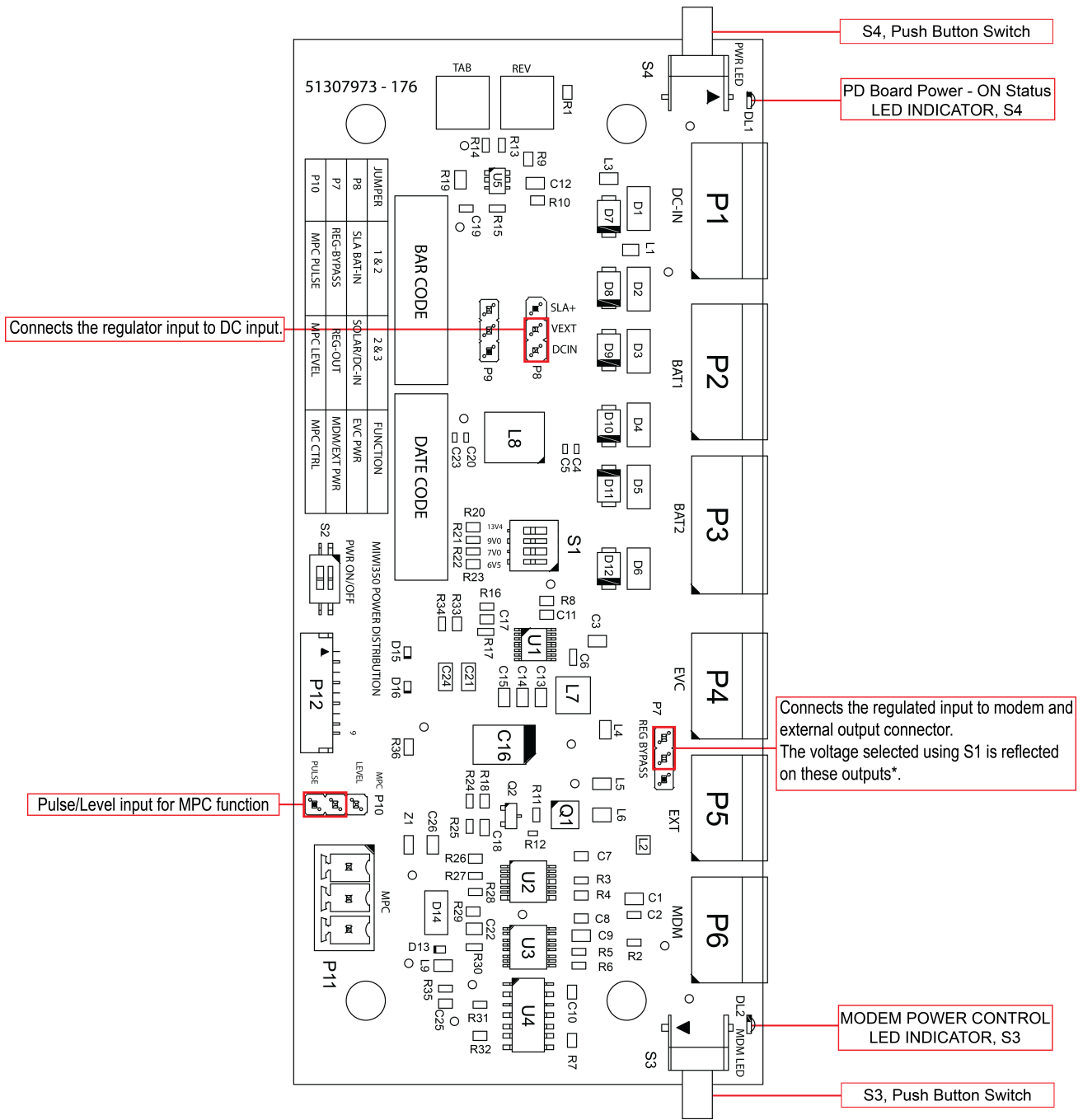

Figure 5-4: Power Distribution Board

**Caution:** Never exceed 9V for Alkaline battery input. The supercap connected cannot work beyond 9V.

## 5.2.3 Power Distribution board Output voltage and Jumper settings

POWER SOURCE	VOLTAGE IN	INSTRUMENT	S1 INSTRUMENT VOLTAGE	MODEM	JUMPER SETTING		MPC
					P7	P8	P10
SOLAR	15V	EC350	13.4V	RV50/RV50X/RV55	1-2	1-2	PULSE
ALKALINE	18V	EC350	9V	RV50/RV50X/RV55	2-3	2-3	PULSE
AC-DC	15V	EC350	13.4V	RV50/RV50X/RV55	1-2	1-2	PULSE
DC	12V	EC350	9V	RV50/RV50X/RV55	2-3	2-3	PULSE
SOLAR	15V	EC350	13.4V	CLR100/R110	1-2	1-2	PULSE
ALKALINE	18V	EC350	9V	CLR100/R110	2-3	2-3	PULSE
AC-DC	15V	EC350	13.4V	CLR100/R110	1-2	1-2	PULSE
DC	12V	EC350	9V	CLR100/R110	2-3	2-3	PULSE
SOLAR	15V	Mini-Max	6.5V	AS PER MSG	1-2	1-2	PULSE
ALKALINE	18V	Mini-Max	6.5V	AS PER MSG	2-3	2-3	PULSE
AC-DC	15V	Mini-Max	6.5V	AS PER MSG	1-2	1-2	PULSE
DC	12V	Mini-Max	6.5V	AS PER MSG	2-3	2-3	PULSE
SOLAR	15V	Mini-AT	9V	AS PER MSG	1-2	1-2	PULSE
ALKALINE	18V	Mini-AT	9V	AS PER MSG	2-3	2-3	PULSE
AC-DC	15V	Mini-AT	9V	AS PER MSG	1-2	1-2	PULSE
DC	12V	Mini-AT	9V	AS PER MSG	2-3	2-3	PULSE

## 5.3 MODEM

The currently supported modems which can be used with a MIWI350 device include:

- [Honeywell CloudLink R100/ Honeywell CloudLink R110-M1 MODEM](#)
- [Sierra Wireless AirLink® RV50 RV50X RV55](#)

**Note:** The modem on the MIWI350 rev B & rev C PD board should always be connected to the P6 connector. The P5 connector is only used to supply power to an external device (such as a super capacitor), and it is not recommended for modem connections.

**Note:** The Unit scans for modem types every minute. If the user changes the modem type (i1458) from CloudLink to Other (non-mercury), it turns off the modem power in the next minute if no modem activities are running.

## 6 Remote Pulsar

The Model 206 Pulse Transmitter from Mercury Instruments is an adaptable solution for transmitting uncorrected volume pulses to a remote EVC. Refer the below pulse input wiring for the interface drawing connections from 206 Pulsar to MIWI350.

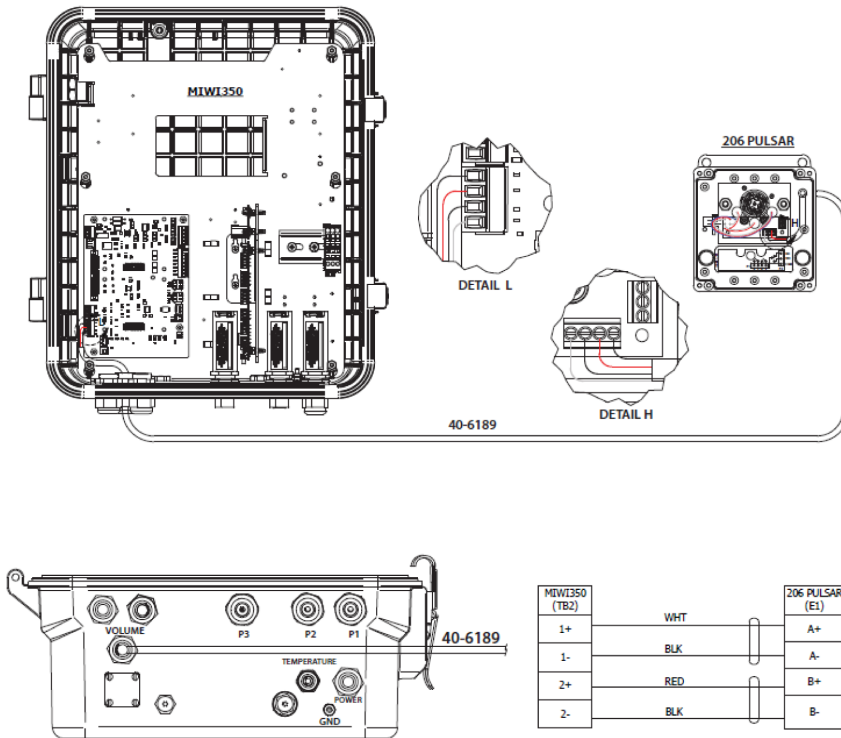

Figure 6-1: Electrical Wiring - Remote Pulsar to MIWI350

## 6.1 Pulsar to MIWI cable connections

Follow the below steps carefully to interface the Pulsar and MIWI350.

Step 1 : Insert the interfacing cable (40-6189) from the Pulsar through the Pulse Input Gland on MIWI350 device.



Step 2 : Plug the interfacing cable (40-6189) to the 4-pin connector of the IO Board (TB2). Refer Detail L in the Figure [here](#).





Step 3 : The other end of the interfacing cable (40-6189) runs to the Pulsar Output gland.

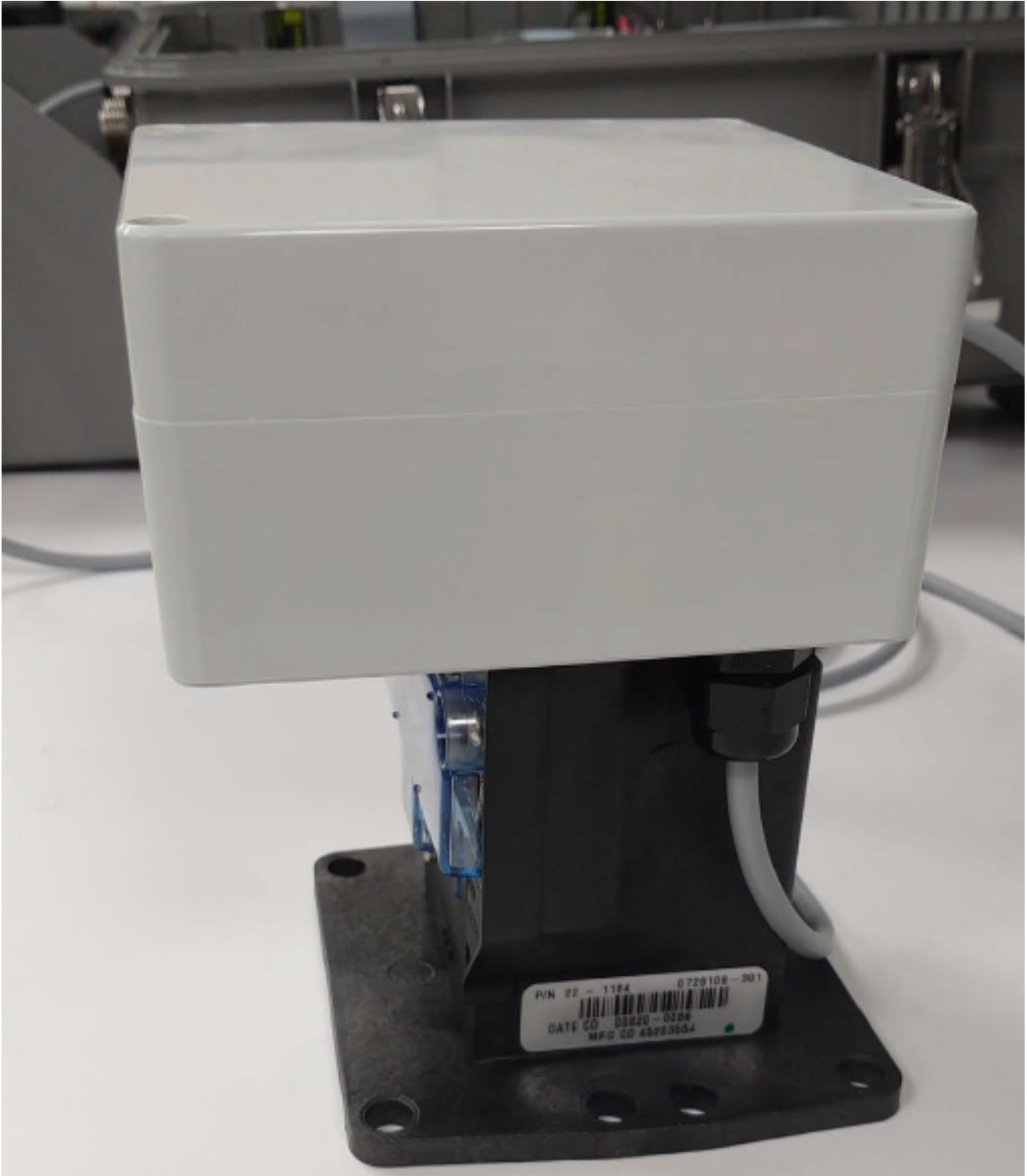

## 6 Remote Pulsar

Step 4 : The connector must be inserted into the Pulsar Board as per the Electrical Wiring diagram (Refer Detail H) shown [here](#).



Step 5 : The final wiring arrangement will be as below. Cross check each connection with the Remote Pulsar Electrical wiring explained in detail [here](#).



Figure 6-2: Cable wiring connections from Remote Pulsar 206 to MIWI350

# 7 Internal Wiring

## 7.1 Power Distribution Board and IO Board

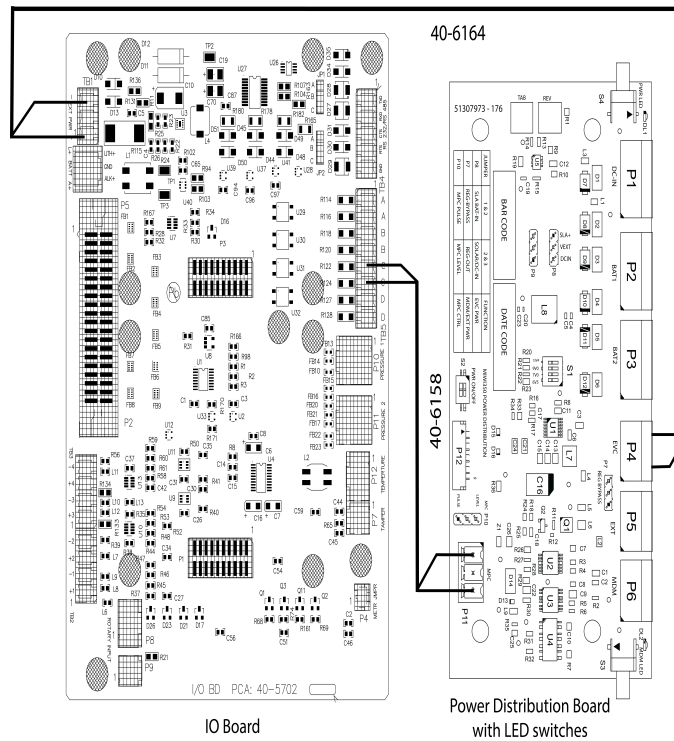

Figure 7-1: Electrical Wiring between Power Distribution Board and IO Board

## 7.2 Power Distribution Board and Modem

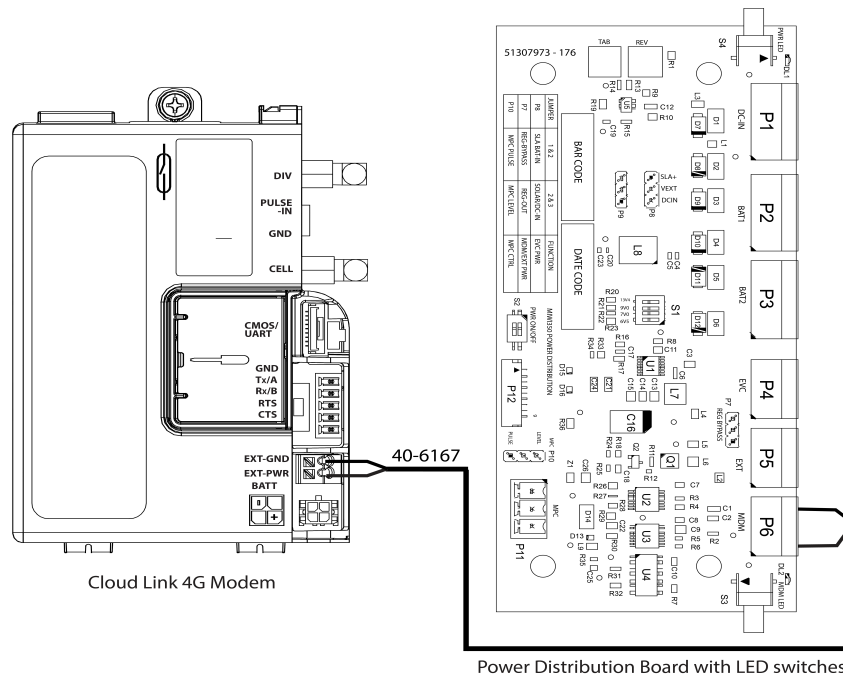

Figure 7-2: Electrical Wiring between Power Distribution Board and CloudLink 4G MODEM

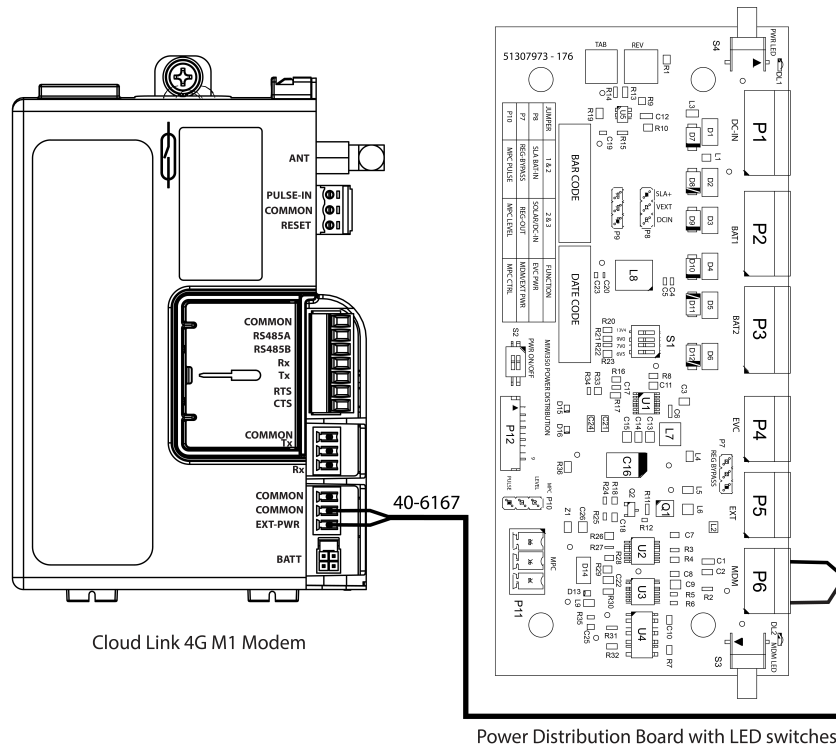

Figure 7-3: Electrical Wiring between Power Distribution Board and CloudLink 4G MODEM

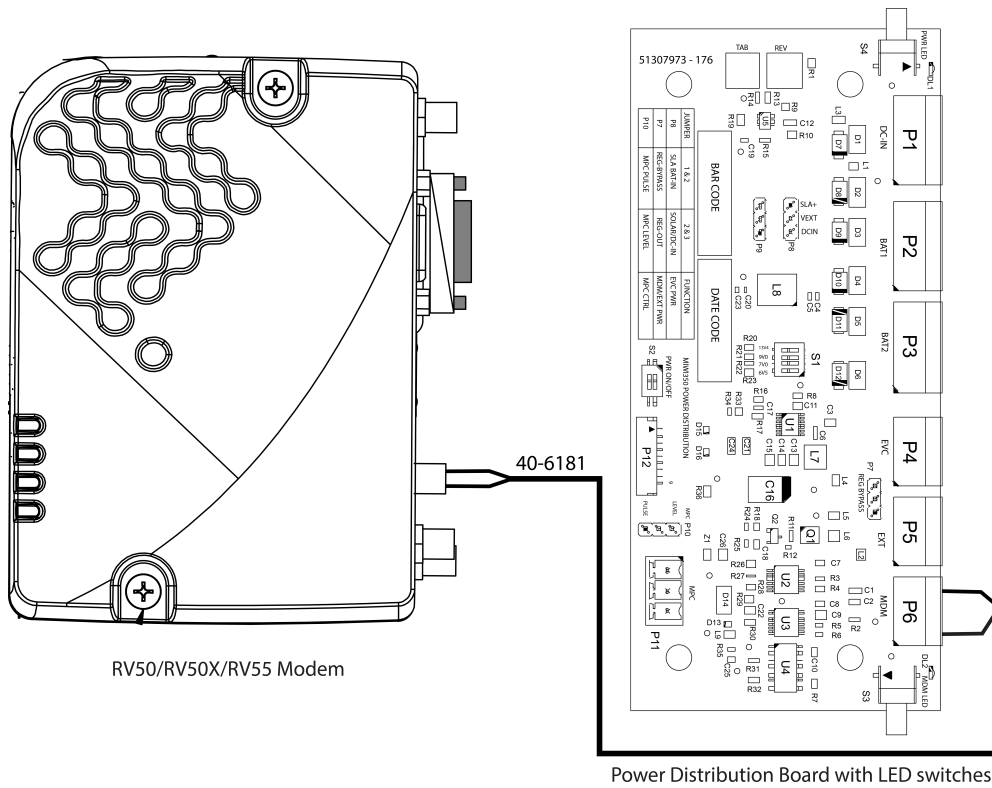

Figure 7-4: Electrical Wiring between Power Distribution Board and RV50/RV50X/RV55 Modem

### 7.3 IO Board and MODEM

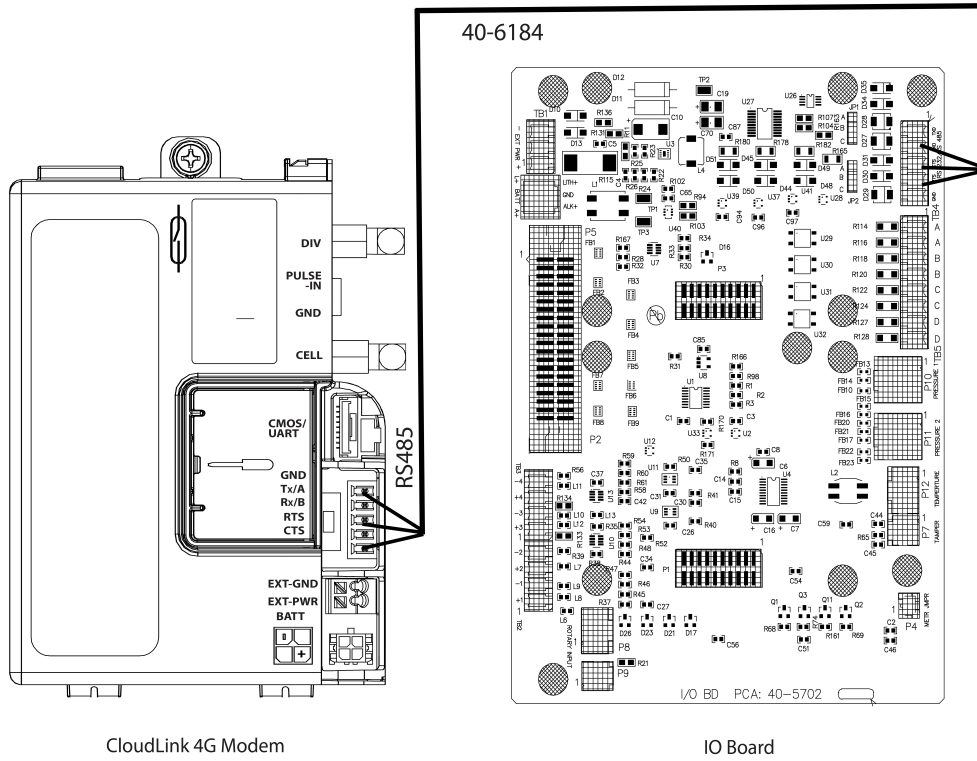

Figure 7-5: Electrical Wiring between IO Board and CloudLink 4G MODEM

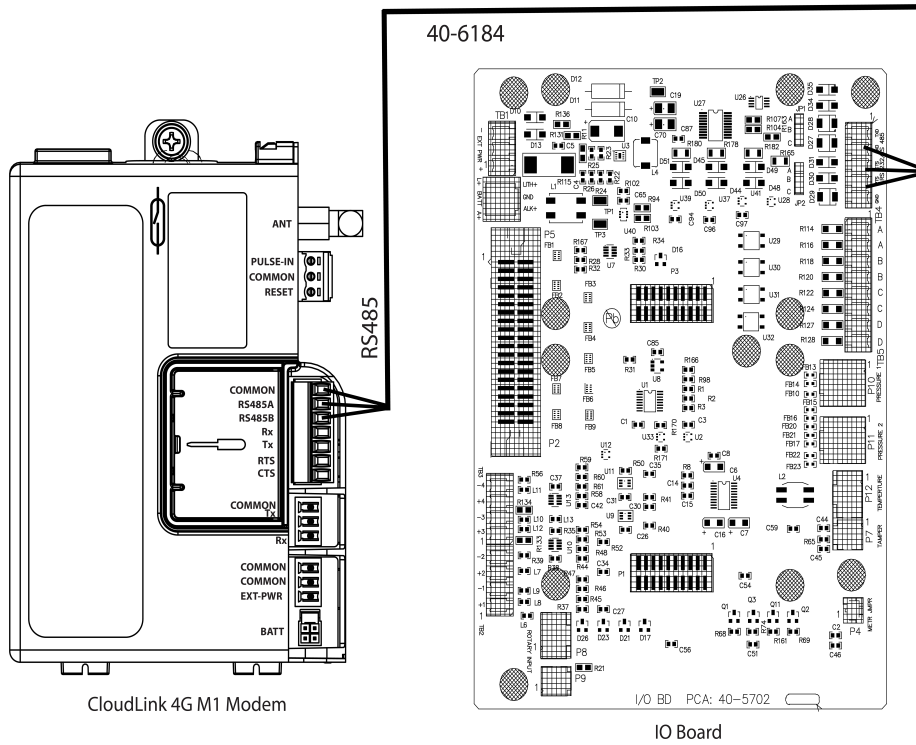

Figure 7-6: Electrical Wiring between IO Board and CloudLink 4G M1 Modem

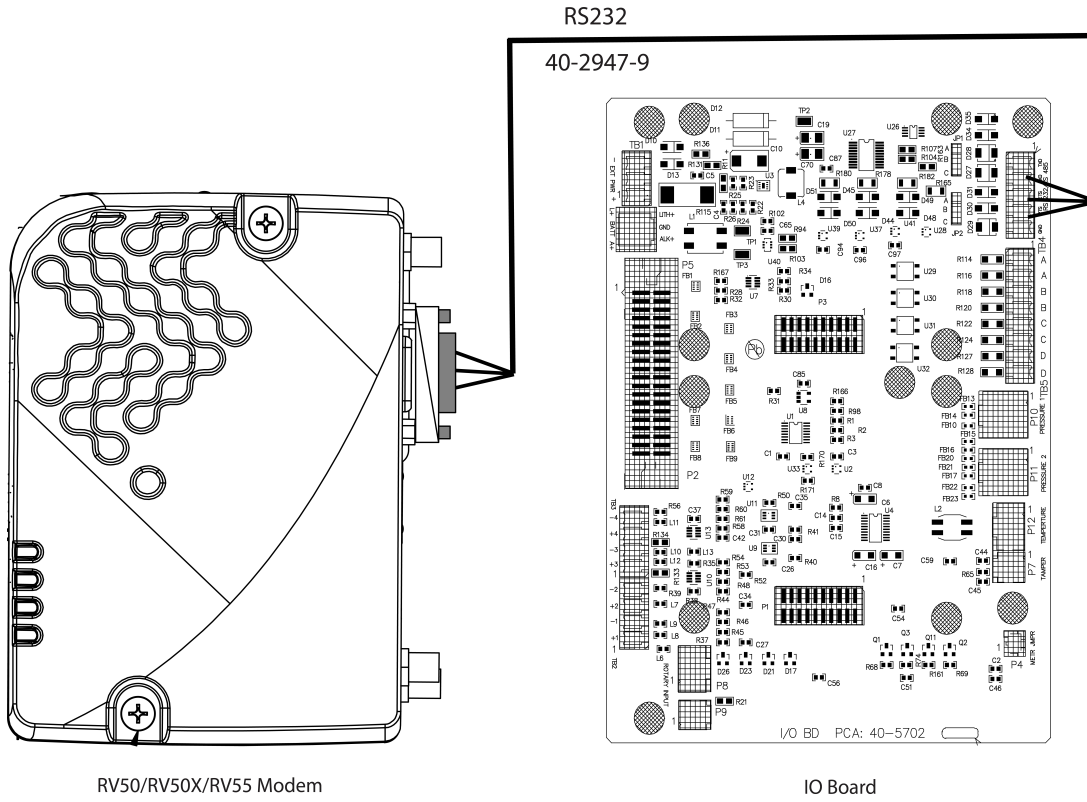

Figure 7-7: Electrical Wiring between IO Board and RV50/RV50X/RV55 Modem

## 8 Battery Installation

### 8.1 Lead-Acid Battery

To install a 7Ah/21Ah lead-acid battery:

1. Quarter turn the screw and open the battery mount bracket flip cover.



2. Carefully insert the battery in the mount bracket.

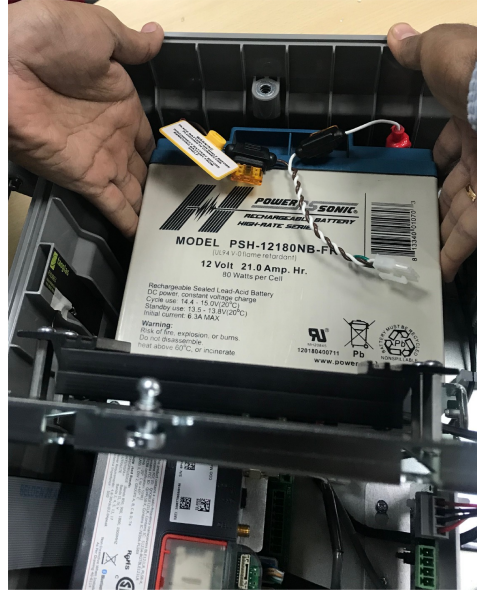

3. Connect the battery cable (\*) to battery charge controller cable.



4. Close the battery mount bracket flip cover by quarter turning the screw.

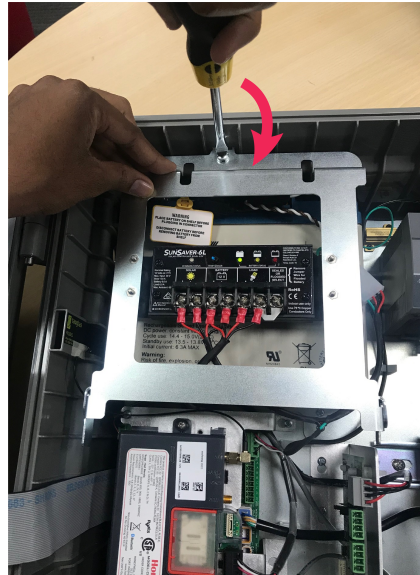

\*40-6169-2 - If you are connecting a 12V 21Ah lead-acid battery for division 2

\*40-6169-3 - If you are connecting a 12V 7Ah lead-acid battery for division 2

"# 40-6169-5 - If you are connecting a 12V 21Ah lead-acid battery for zone 2

# 40-6169-6 - If you are connecting a 12V 7Ah lead-acid battery for zone 2.

## 8.2 Dual/Quad Alkaline Battery

To install a Dual/Quad alkaline battery pack:

1. Quarter turn the screw

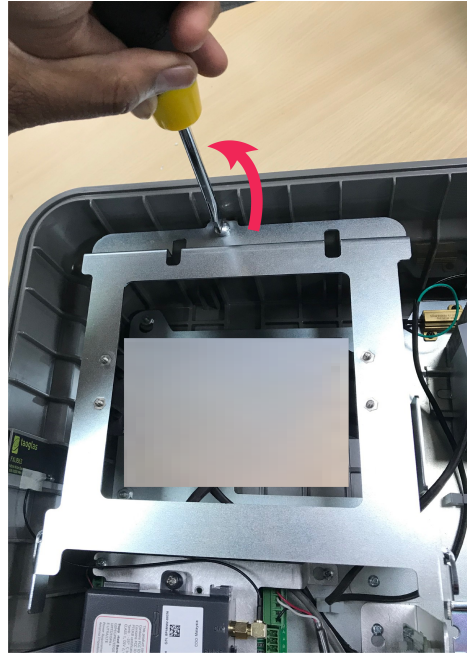

2. Carefully insert the battery packs into the mount bracket.

Dual battery pack



Quad Battery pack

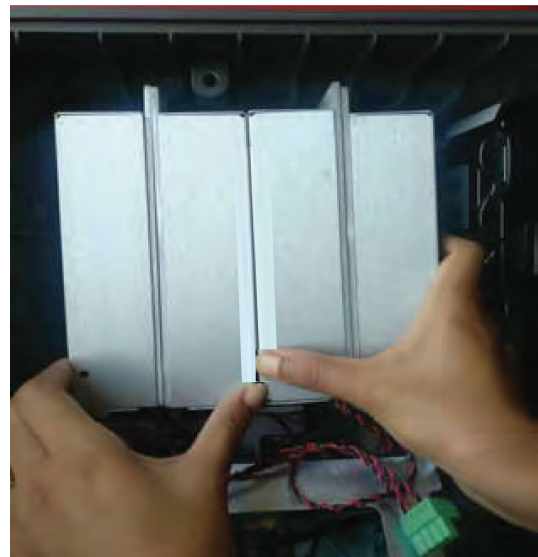



## 8 Battery Installation

3. Close the battery mount flip cover and turn back the screw.



4. Connect the dual/quad battery cable to power distribution board \*

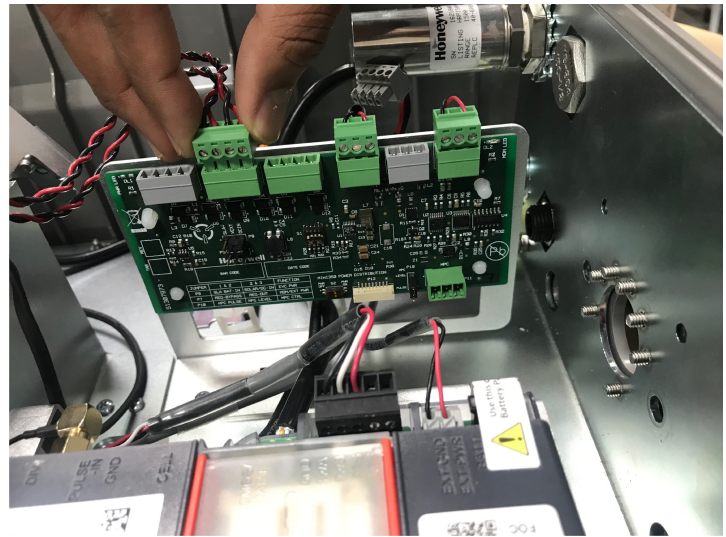

\*Refer **Section 8.3.1.2** for detailed wiring connections.

### 8.3 Battery Life (approximate)

*MIWI350 with CloudLink MODEM (1 call/day)*

Battery Type	Months	
	CLR100	CLR110
7Ah 12V DC SLA	2.0	2.4
21Ah 12V DC SLA	6.0	7.3
Dual Alkaline Battery pack (12Ah-derated)	6.9	8.3
Quad Alkaline Battery Pack (24Ah-derated)	13.7	16.6

*MIWI350 with Sierra RV50/RV50X/RV55 (1 call/day)*

Battery Type	Months
	RV50/RV50X/RV55
7Ah 12V DC SLA	2.0
21Ah 12V DC SLA	6.0
Dual Alkaline Battery pack (12Ah-derated)	6.8
Quad Alkaline Battery Pack (24Ah-derated)	13.7

\*RV50/RV50X/RV55 MODEM power controlled

**Note:** Please note that the Battery life values may slightly vary due to poor network conditions, bad signal quality and extreme temperature conditions.

## 9 SLA Alarm Scenarios

SLA Battery alarm functionality under few scenarios are detailed below. Note these item parameters to understand the alarm behavior in detail.

ITEM NUMBER	DESCRIPTION	OPTIONS/RANGE
1607	SLA Not Charging Alarm Days	0-255 days (0 means alarm will be disabled)
1608	SLA Not Charging Alarm	Active/Inactive
1614	SLA Not charging alarm counter	in days

### Scenario 1: SOLAR PANEL REPLACEMENT

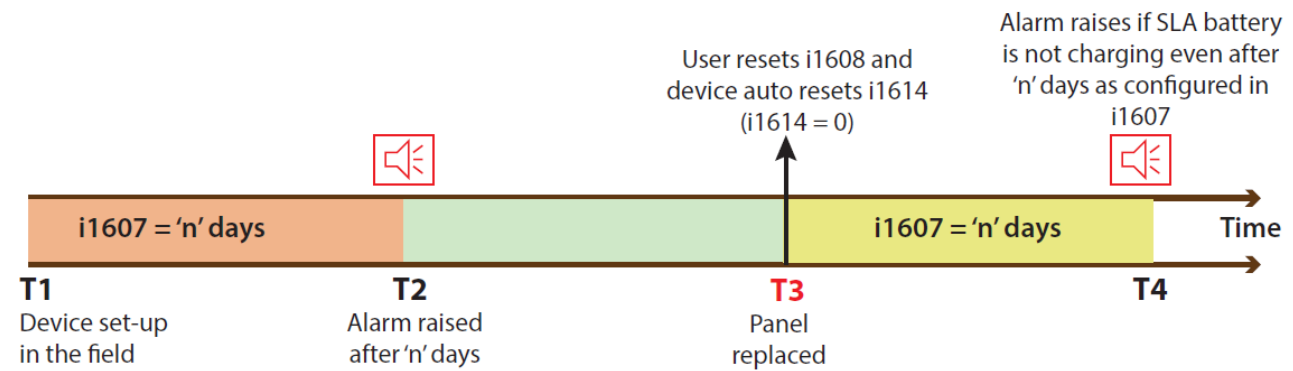

Example:

At **T1** i1607 is configured as 10 (days). After 10 days of SLA not charging, alarm raises at **T2**.

At **T3**, if the solar panel is replaced after 5 days from **T2** user has to reset the alarm i1608 so as to restart the battery monitoring from **T3**. Then, the device auto resets the alarm counter i1614 (value=0).

At **T4**, alarm raises if SLA battery is not charging after 10 days (i1607 configured value).

### Scenario 2: REGULAR MAINTENANCE (OR WHEN SOLAR PANEL LOST/STOLEN)

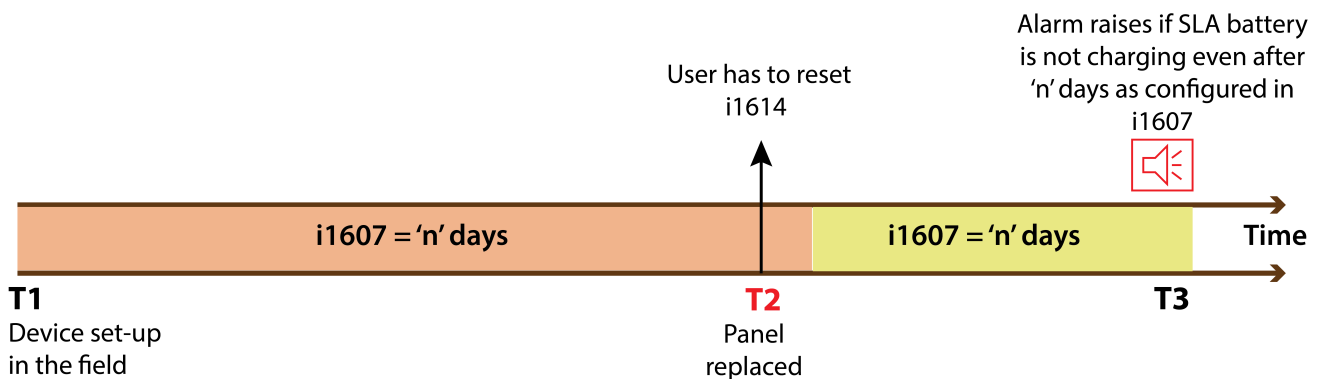

Example:

At **T1** i1607 is configured as 10 (days).

Within 10 days at **T2** if the solar panel is replaced then, the user has to first reset alarm counter i1614 (value=0). This will enable the device to restart the battery voltage monitoring for the alarm from **T2** and this indicates to the device that an external user action (panel replacement) has happened.

At **T3**, alarm raises if SLA battery is not charging after 10 days (i1607 configured value) from **T2**.

**Scenario 3: WHEN ITEM NUMBER 1607 IS CHANGED**

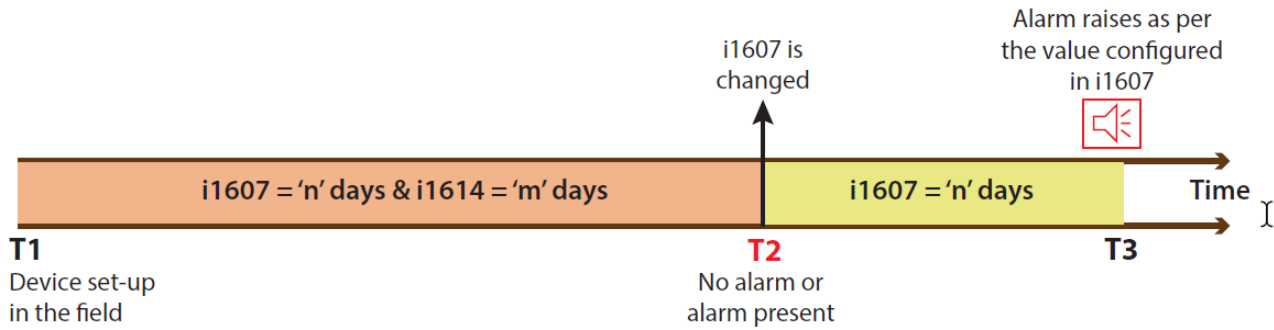

Example:

At T1  $i1607$  is configured as 10 days and  $i1614$  as 5 days. Considering alarm active or inactive status we have two conditions as given below:

a. Alarm is Inactive; At T2

- When user changes  $i1607$  to 15 days then,  $i1614$  resumes the count from 5 until the user resets its value.
- If user changes  $i1607$  to 4 days then, an alarm will be instantly generated as the alarm counter has already gone beyond 5 days. In order to avoid the immediate alarm raise, user has to first clear the alarm counter  $i1614$ .
- So, when  $i1614$  alarm counter is first reset (value = 0) and  $i1607$  is changed to 4 days then, no alarm will be generated.

b. Alarm is Active; At T1  $i1607$  is configured as 10 days and  $i1614$  as 15 days.

- After 10 days an alarm will be generated at T2. As the alarm is active, and changing  $i1607$  or the actual counter value ( $i1614$ ) will not have an impact on the alarm status. User should clear the alarm once it is raises so as to allow the battery voltage monitoring from that time.

At T3, alarm raises if SLA battery is not charging after 'n' days ( $i1607$  configured value) from T2.

**Scenario 4: NEW INSTALLATION/WHEN DEVICE POWER CYCLE**

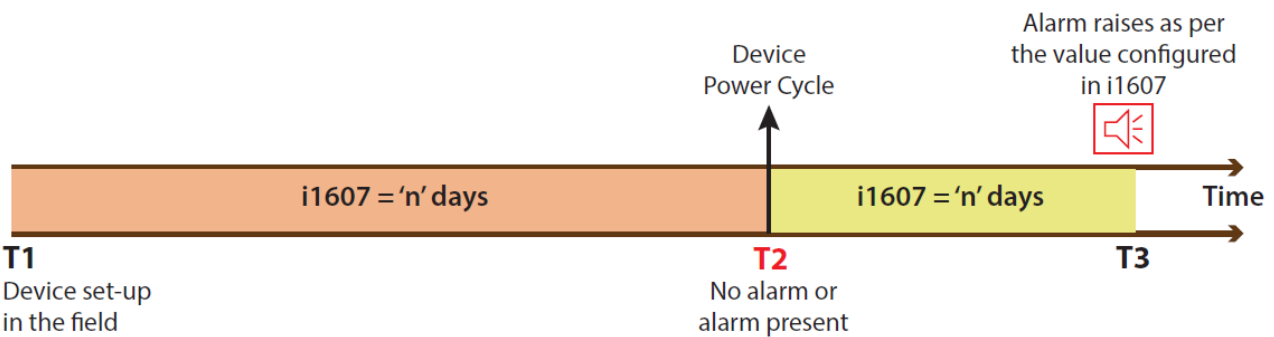

Example:

At T1  $i1607$  is configured as 10 days.

At T2 when the device is power cycled, the alarm counter  $i1614$  resets (to zero). At T3, alarm raises if SLA battery is not charging after 'n' days ( $i1607$  configured value) from T2.

# 10 Reference Drawings

## 10.1 MIWI350 with EC350 or ERX350

### 10.1.1 Wiring Dual or Quad Battery

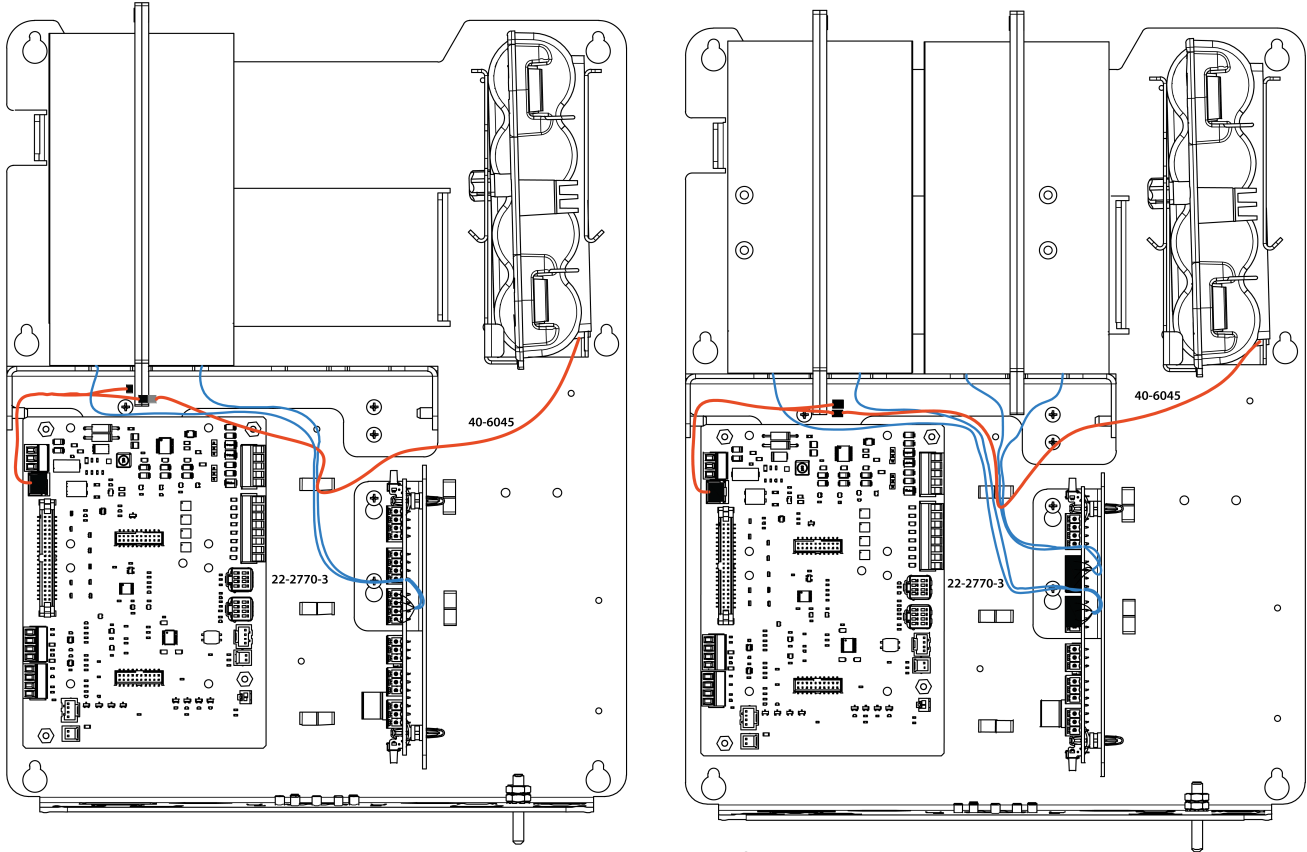

**Note:** The cable color code/pin mapping are for illustration purpose only.

**Figure 10-1:** Electrical Wiring - DUAL/QUAD 18VDC ALKALINE RECEPTACLE PACK

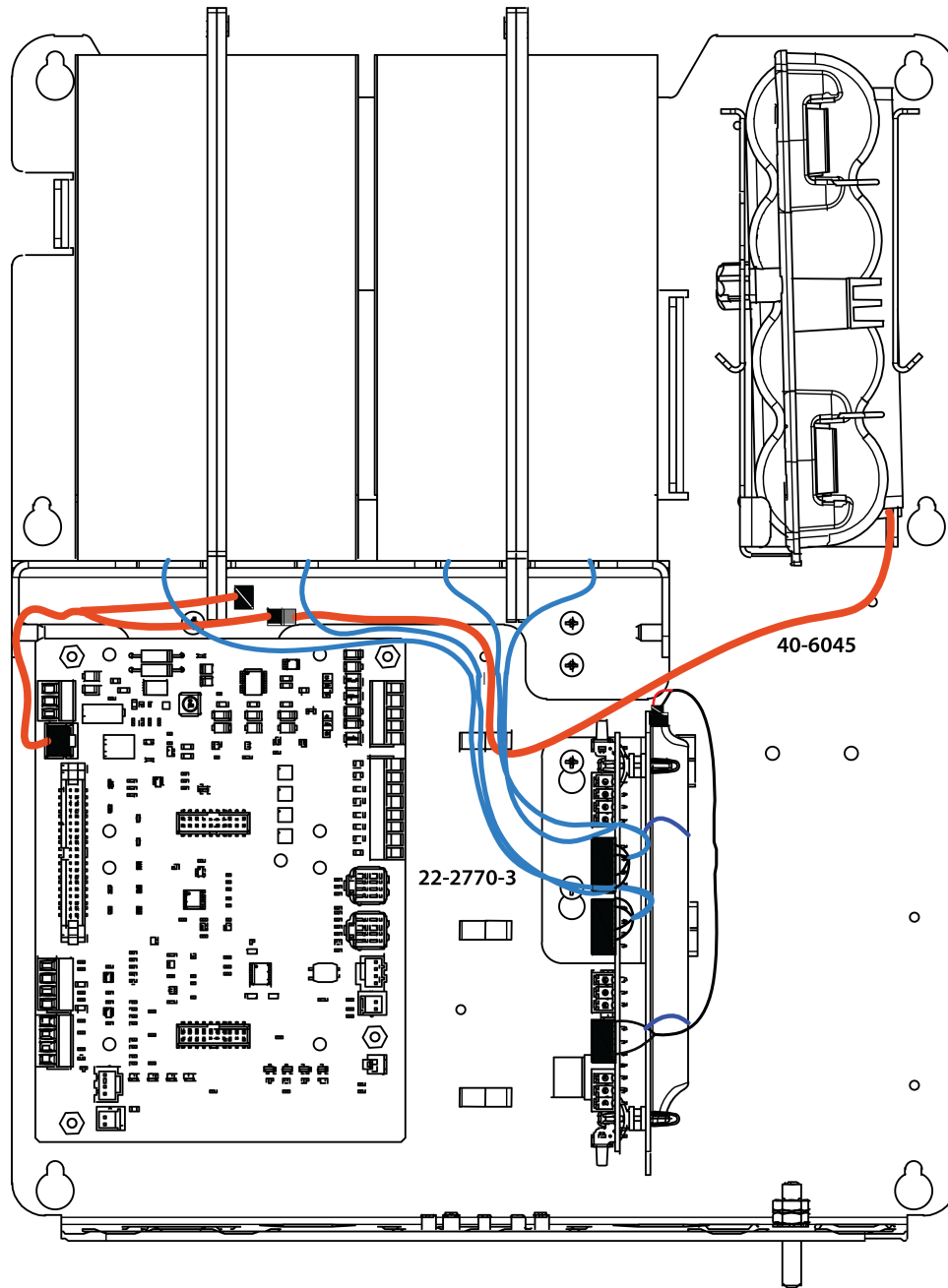

**Note:** The cable color code/pin mapping are for illustration purpose only.

**Figure 10-2:** Electrical Wiring - DUAL/QUAD 18VDC ALKALINE RECEPTACLE PACK WITH SUPERCAP

Cable (Part#)	Connects	To
40-6045	Optional External DC Power Source/Super Capacitor	IO Board TB1-1 & TB1-3
22-2770-3	Connector from Dual Alkaline Receptacle pack (1 & 2)	Power Distribution Board P2 (BAT1)
	Connector from Dual Alkaline Receptacle pack (3 & 4)	Power Distribution Board P2 (BAT2)

### 10.1.2 Wiring Solar or External DC Power (13.5 to 15V DC) for MIWI350

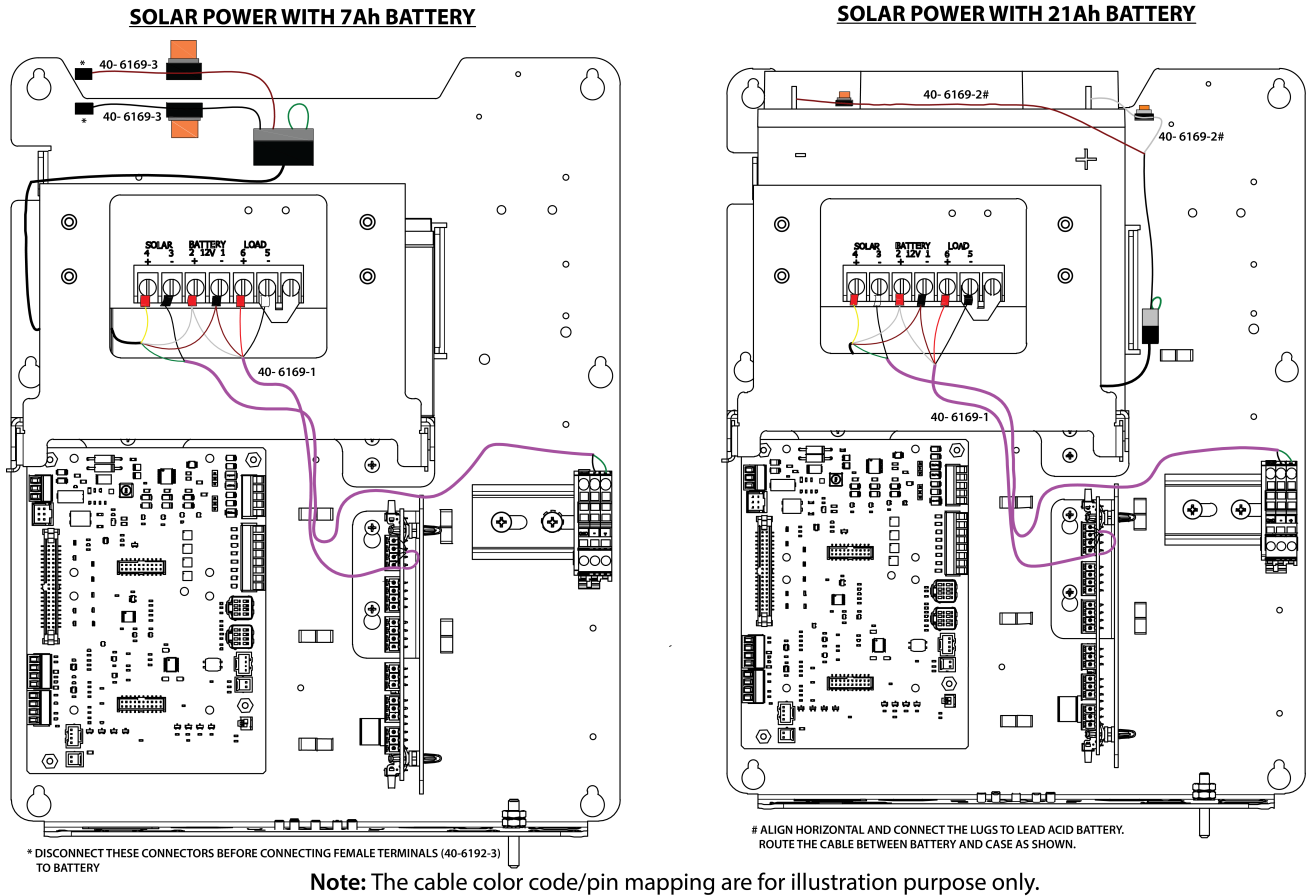

**Figure 10-3:** Electrical Wiring - SOLAR POWER WITH 7Ah/21Ah SLA BATTERY

Cable (Part#)	Connects	To
40-6169-1	Connector from Solar Charge controller	External power input terminal block
	Connector from Solar Charge controller	Power Distribution Board P1 (DC-IN)
40-6169-2	Connector from Solar Charge controller	12V 21Ah lead-acid battery
40-6169-3	Connector from Solar Charge controller	12V 7Ah lead-acid battery

**Caution:** For Zone2 installations, While using "Ready for Solar variants" - The customer needs to use an IECEx Zone2 certified solar Panels only.

### 10.1.3 Wiring AC-DC Power for DIV2

**120-230VAC TO 15V DC ADJ WITH 7Ah BATTERY**

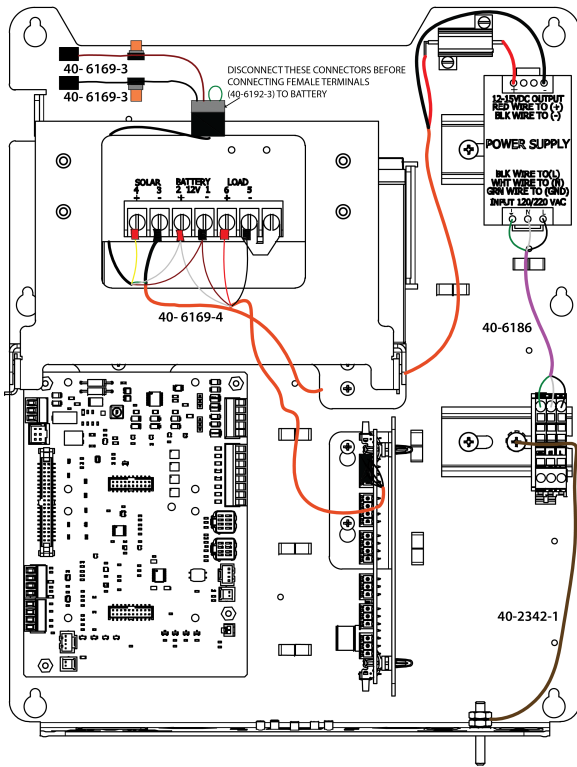

**120-230VAC TO 15V DC ADJ WITH 21Ah BATTERY**

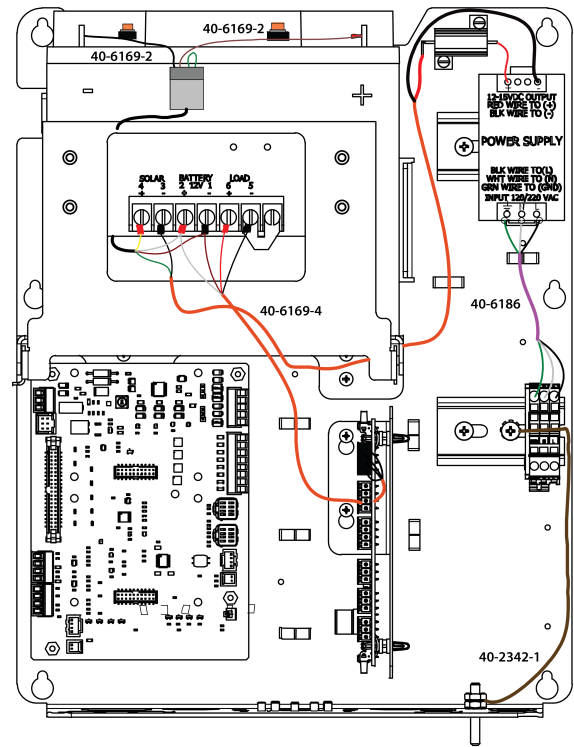

**Note:** The cable color code/pin mapping are for illustration purpose only.

**Figure 10-4:** Electrical Wiring - AC-DC POWER 120VAC TO 12-15VDC ADJ WITH 7Ah/21Ah BATTERY

Cable (Part#)	Connects	To
40-6169-3	Connector from Solar Charge controller	12V 7Ah lead-acid battery
40-6169-2	Connector from Solar Charge controller	12V 21Ah lead-acid battery
40-6169-1	Connector from Solar Charge controller	Power Supply source 120VAC/ 12-15VDC Din Rail Mount.
	Connector from Solar Charge controller	Power Distribution Board P1(DC-IN)
40-6186	External power input junction box	Power Supply source 120VAC/ 12-15VDC Din Rail Mount.
40-2342-1	Device Ground/Earthing	External power input Terminal Block

**Note:** Refer Section 4.3.1 for Power input cable glands and torque to be applied.

10.1.4 Wiring AC-DC Power for DIV2

120VAC/12-15V ADJ POWER SUPPLY WITH 7Ah BATTERY

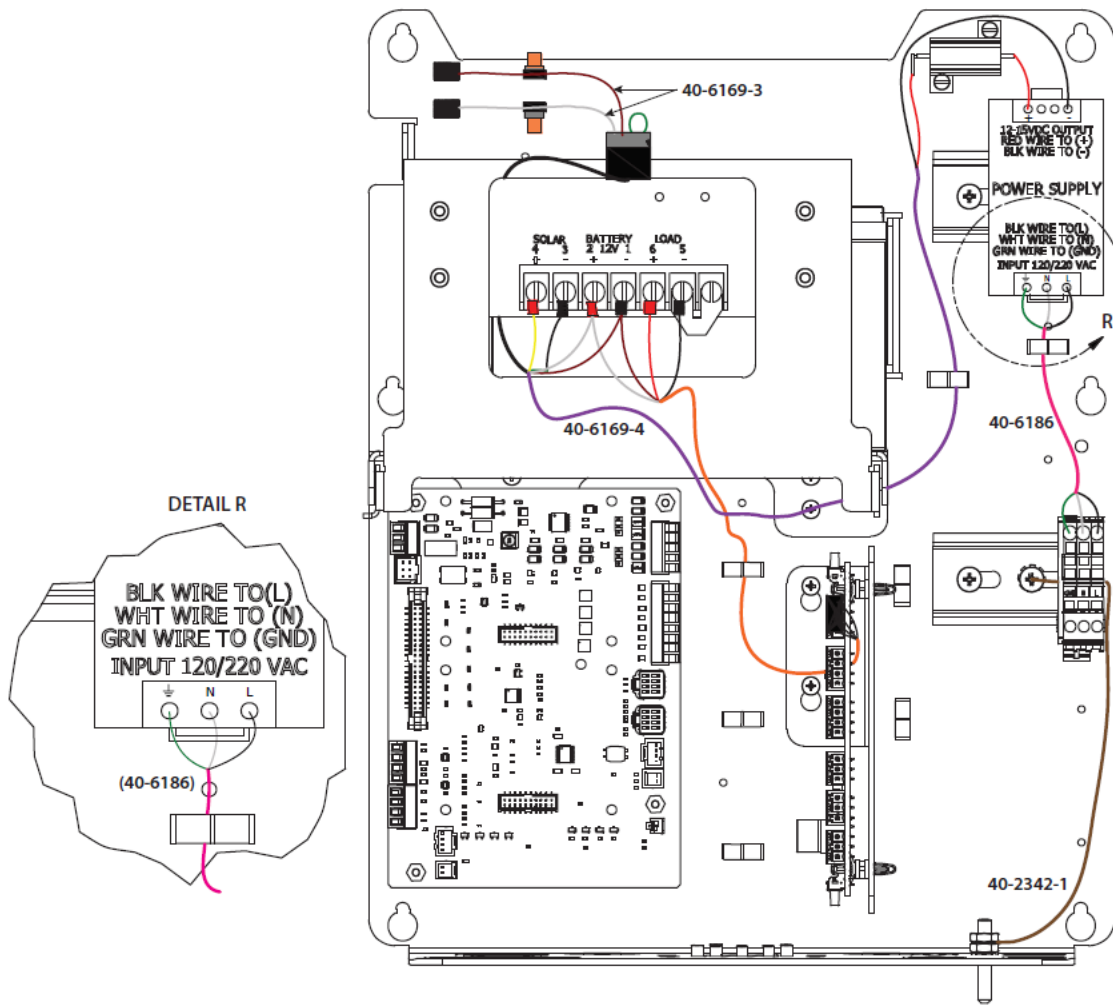

Figure 10-5: Electrical Wiring - 120V AC TO 12-15V DC ADJUSTABLE POWER SUPPLY WITH 7Ah BATTERY



120VAC/12-15V ADJ POWER SUPPLY WITH 21Ah BATTERY

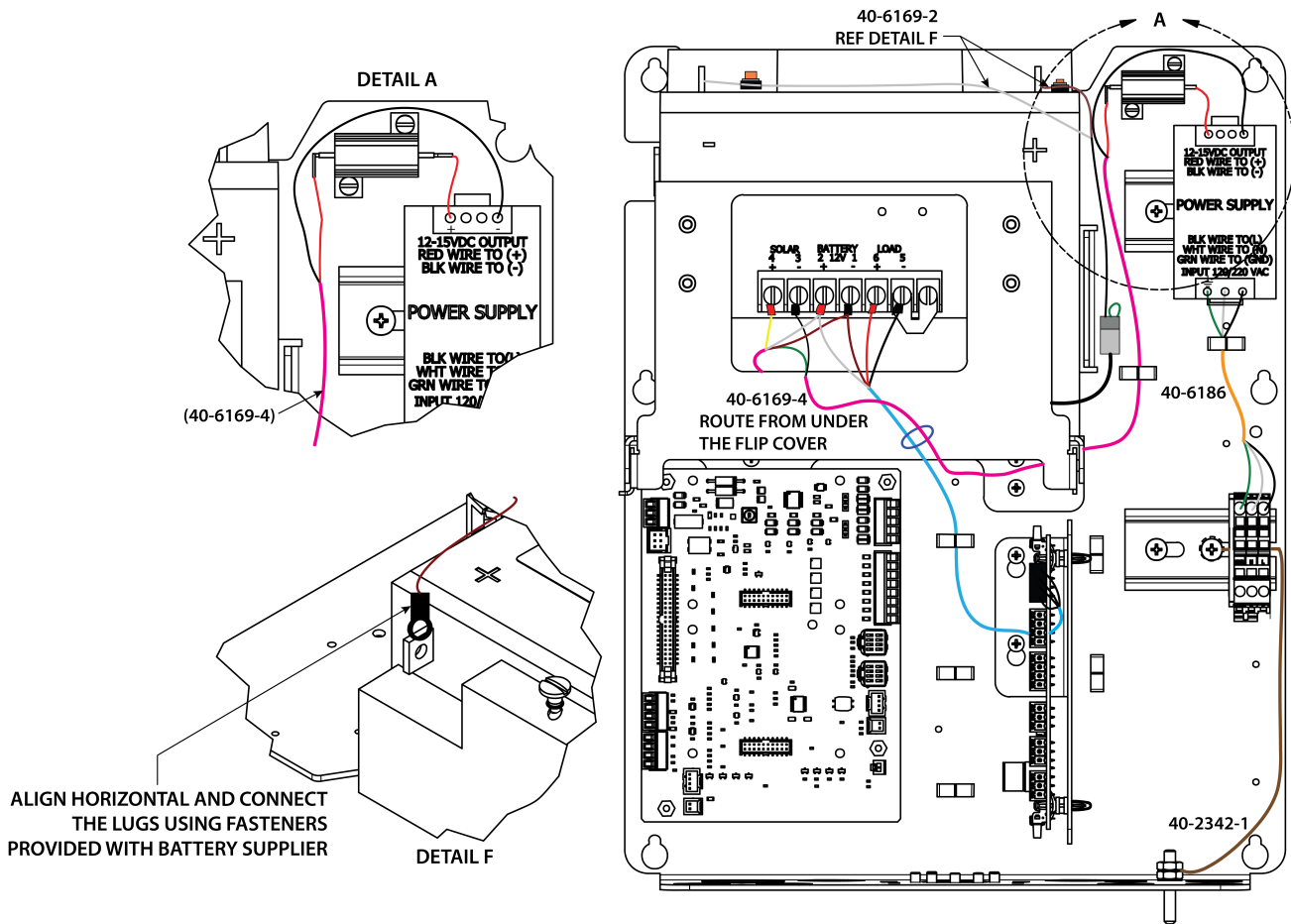

Figure 10-6: Electrical Wiring - AC-DC POWER 120VAC TO 15V DC ADJ WITH 7Ah/21Ah BATTERY

Cable (Part#)	Connects	To
40-6169-4	Connector from Solar Charge controller	Power Distribution Board P1 (DC-IN)
		Power Supply source 120VAC/15V DC Din Rail Mount
40-6186	External power input terminal block	Power Supply source 120VAC/15V DC Din Rail Mount
40-6169-2	Connector from Solar Charge controller	12V 21Ah lead-acid battery
40-6169-3	Connector from Solar Charge controller	12V 7Ah lead-acid battery
40-2342-1	Device Ground/Earthing	External Power Input Terminal Block

**Note:** Refer Section 4.3.1 for Power input cable glands and torque to be applied.

### 10.1.5 Wiring AC-DC Power for Zone2

#### 230V AC/12-15V ADJ POWER SUPPLY WITH 7Ah BATTERY

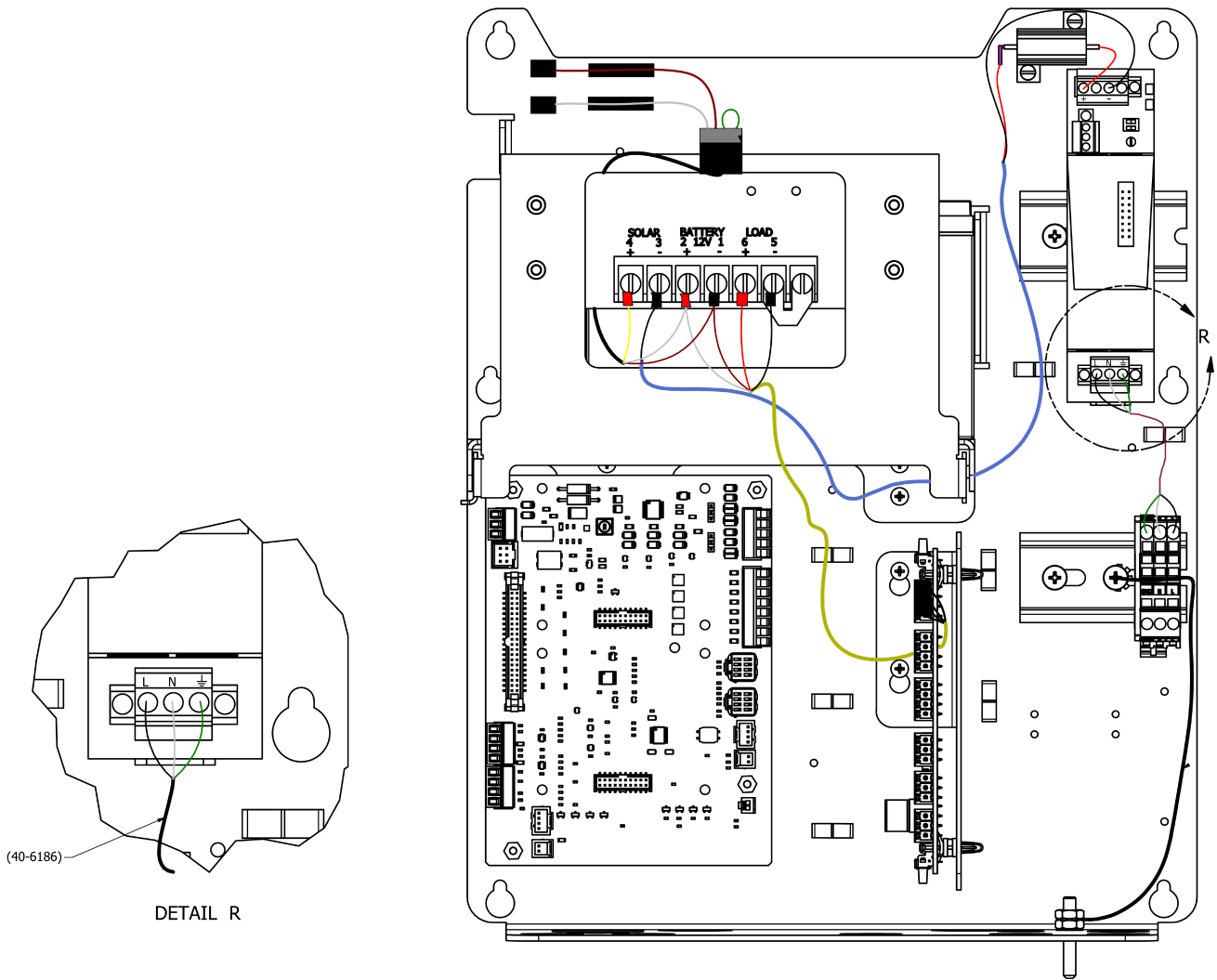

**Figure 10-7:** Electrical Wiring - 230V AC TO 12-15V DC ADJUSTABLE POWER SUPPLY WITH 7Ah BATTERY

**230V AC/12-15V ADJ POWER SUPPLY WITH 21Ah BATTERY**

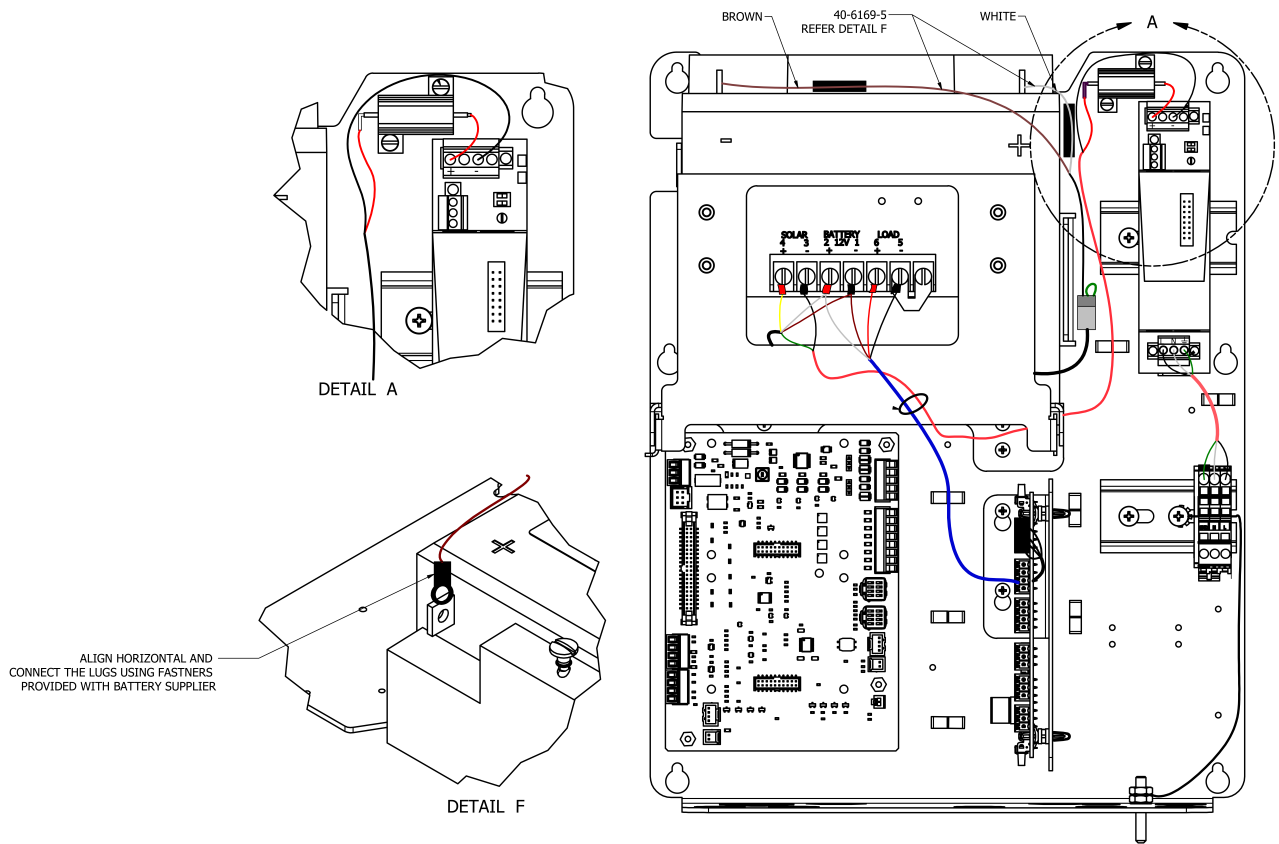

**Figure 10-8:** Electrical Wiring - AC-DC POWER 230V AC TO 15V DC ADJ WITH 7Ah/21Ah BATTERY

Cable (Part#)	Connects	To
40-6169-4	Connector from Solar Charge controller	Power Distribution Board P1 (DC-IN)
		Power Supply source 120VAC/15V DC Din Rail Mount
40-6186	External power input terminal block	Power Supply source 120VAC/15V DC Din Rail Mount
40-6169-5	Connector from Solar Charge controller	12V 21Ah lead-acid battery - Zone 2
40-6169-6	Connector from Solar Charge controller	12V 7Ah lead-acid battery - Zone 2
40-2342-1	Device Ground/Earthing	External Power Input Terminal Block

10.1.6 Wiring External DC Power

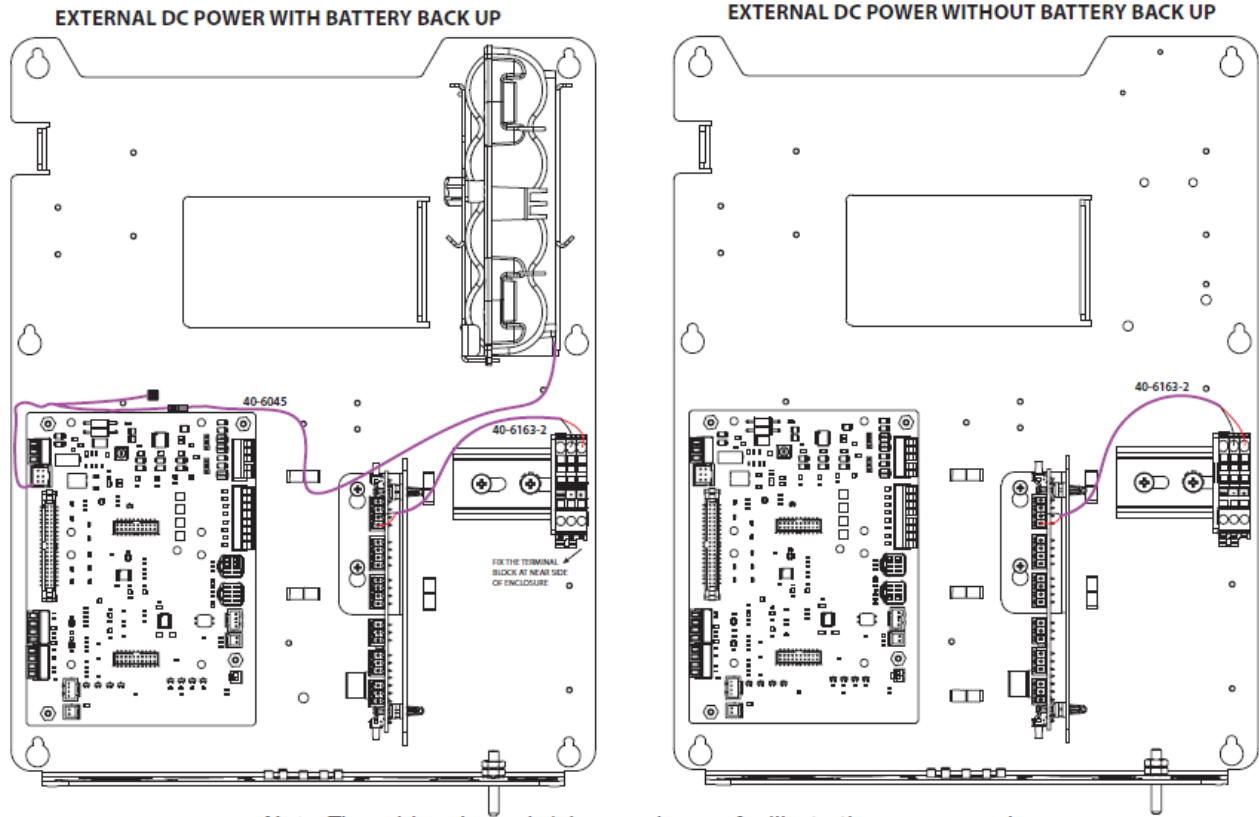

Note: The cable color code/pin mapping are for illustration purpose only.

Figure 10-9: Electrical Wiring - External 12V DC

Cable (Part#)	Connects	To
40-6045	External Optional alkaline back-up battery pack	IO Board TB1-1 & TB1-3
40-6163-2	External power input terminal block	Power Distribution Board P1 (DC-IN)

## 10.2 MIWI350 as Power Box

### 10.2.1 Wiring Dual or Quad Battery for MIWIPCB

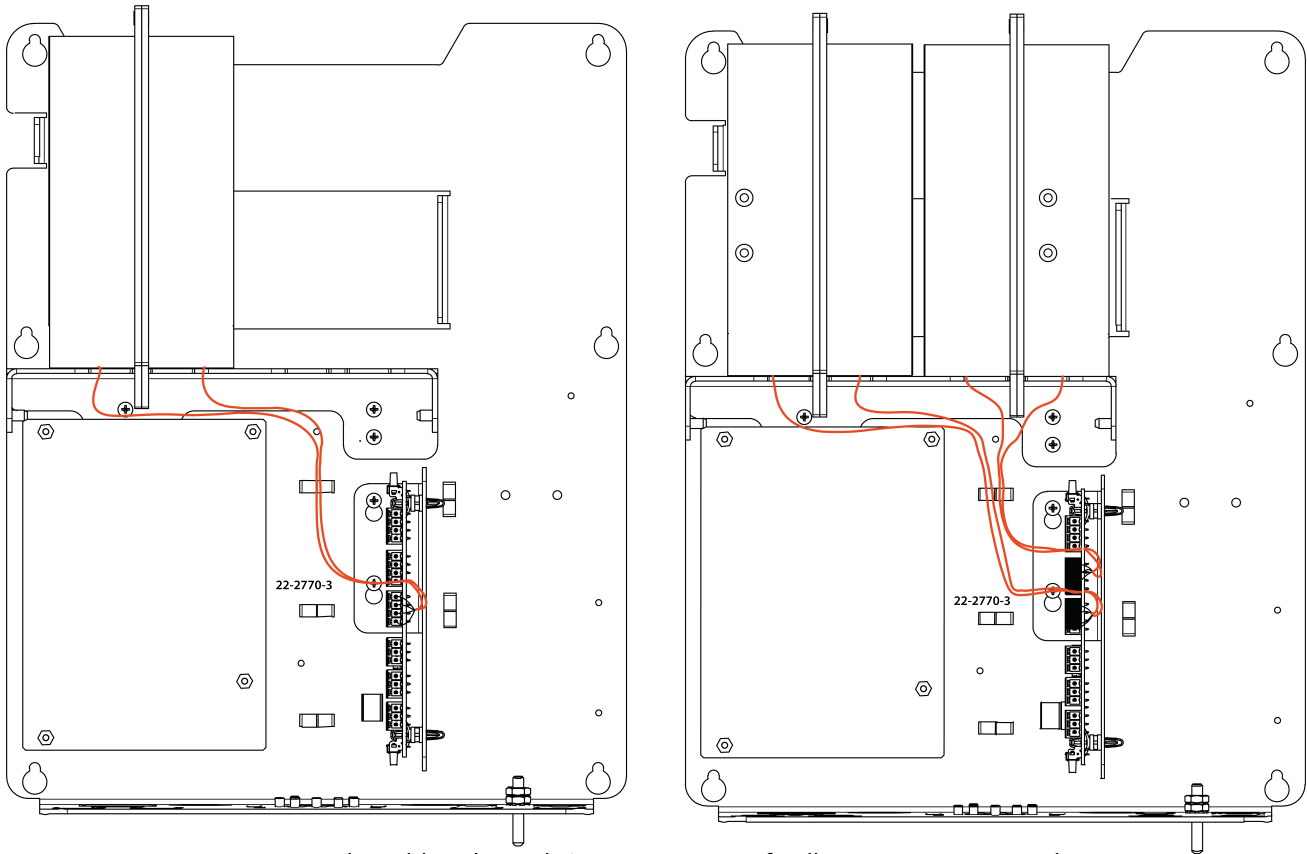

**Note:** The cable color code/pin mapping are for illustration purpose only.

**Figure 10-10:** Electrical Wiring - DUAL/QUAD 18VDC ALKALINE RECEPTACLE PACK

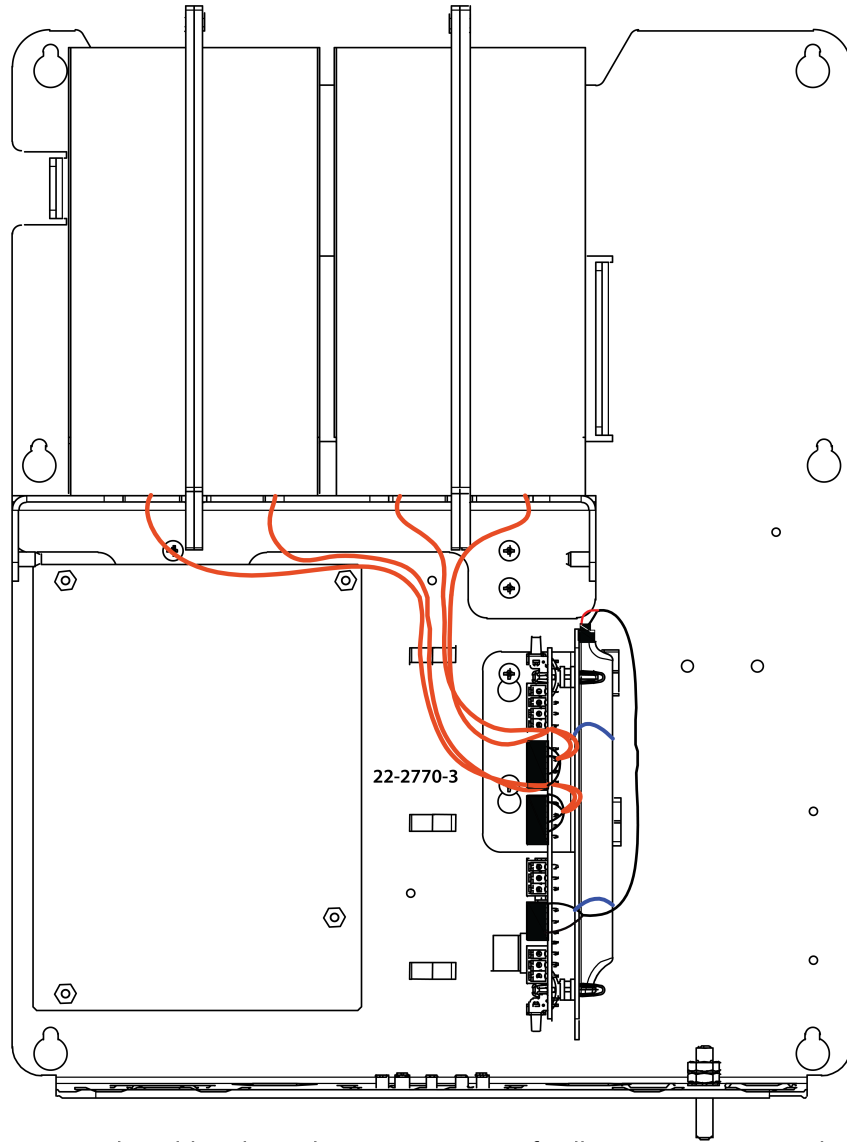

**Note:** The cable color code/pin mapping are for illustration purpose only.

**Figure 10-11:** Electrical Wiring - DUAL/QUAD 18VDC ALKALINE RECEPTACLE PACK WITH SUPERCAP

Cable (Part#)	Connects	To
22-2770-3	Connector from Dual Alkaline Receptacle pack (1 & 2)	Power Distribution Board P2 (BAT1)
22-2770-3	Connector from Dual Alkaline Receptacle pack (3 & 4)	Power Distribution Board P2 (BAT2)

10.2.2 Wiring Solar or External DC (13.5 to 15V DC) Power for MIWIPCB

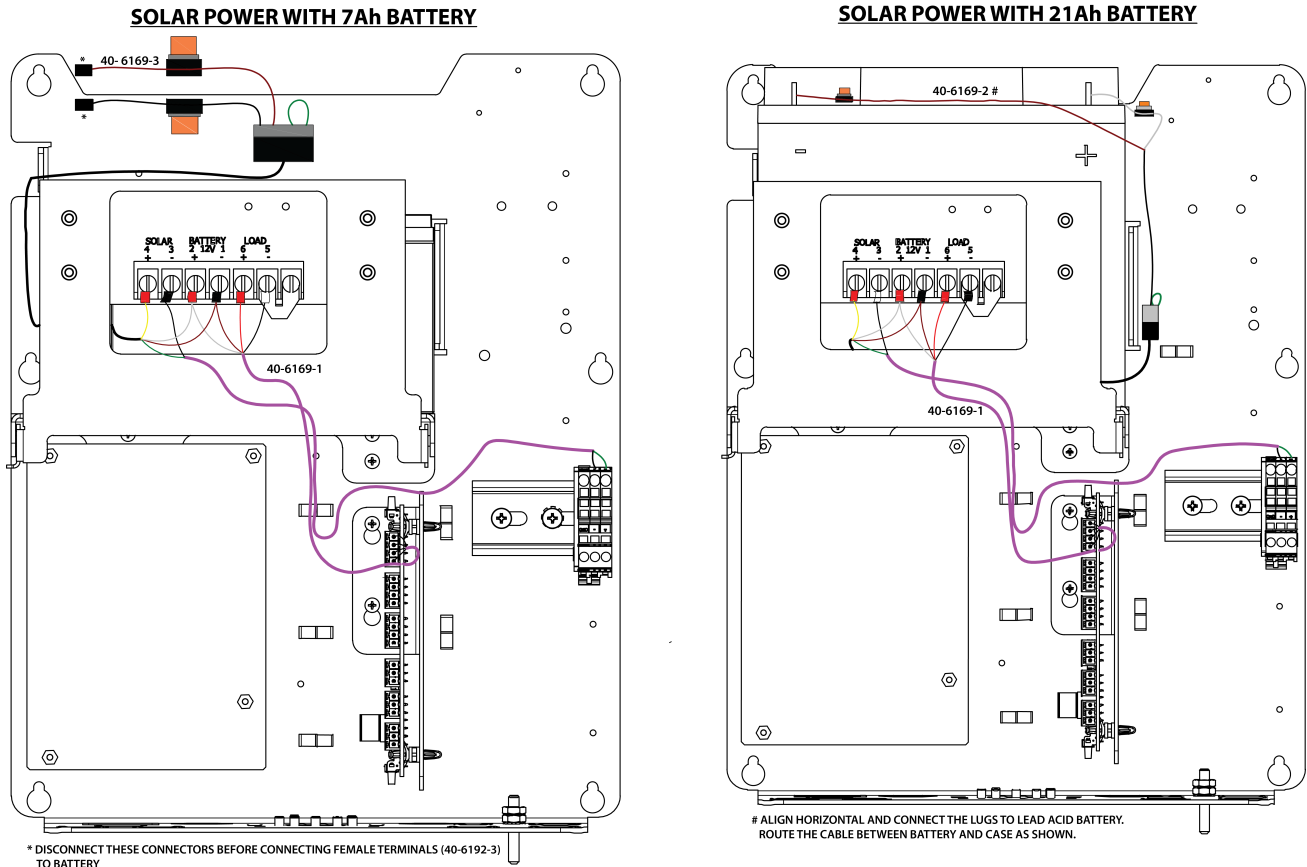

Note: The cable color code/pin mapping are for illustration purpose only.

Figure 10-12: Electrical Wiring - SOLAR POWER WITH 7Ah/21Ah SLA BATTERY

Cable (Part#)	Connects	To
40-6169-1	Connector from Solar Charge controller	External power input terminal block
	Connector from Solar Charge controller	Power Distribution Board P1 (DC-IN)
40-6169-2	Connector from Solar Charge controller	12V 21Ah lead-acid battery
40-6169-3	Connector from Solar Charge controller	12V 7Ah lead-acid battery

### 10.2.3 Wiring AC DC Power for MIWIPCB

**120-230VAC TO 15V DC ADJ WITH 7Ah BATTERY**

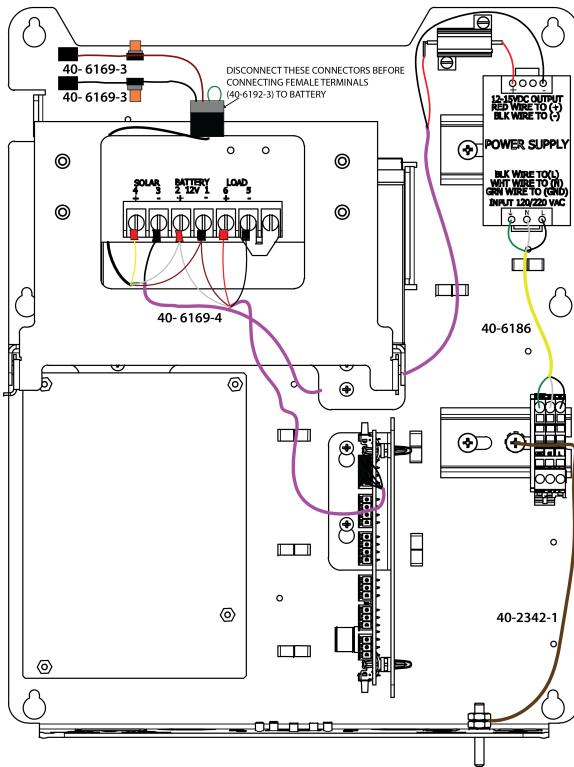

**120-230VAC TO 15V DC ADJ WITH 21Ah BATTERY**

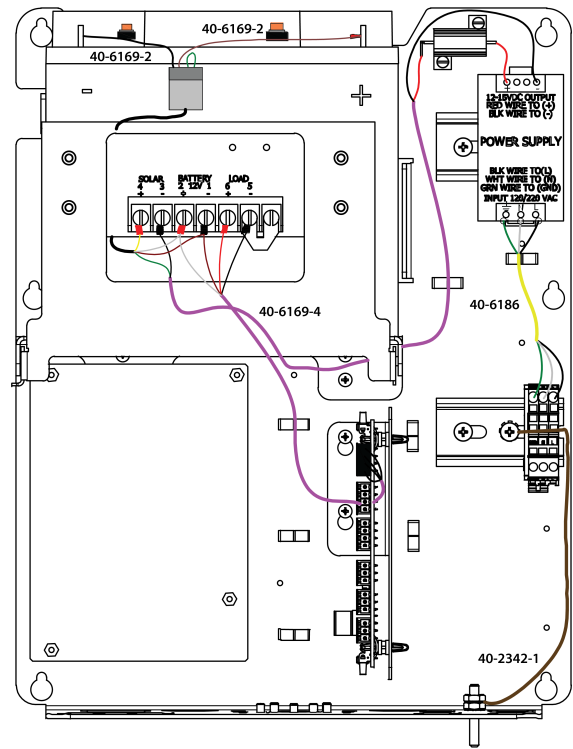

**Note:** The cable color code/pin mapping are for illustration purpose only.

**Figure 10-13:** Electrical Wiring - AC-DC POWER 120VAC TO 15V DC ADJ WITH 7Ah/21Ah BATTERY

Cable (Part#)	Connects	To
40-6169-4	Connector from Solar Charge controller	Power Distribution Board P1 (DC-IN)
		Power Supply source 120VAC/15V DC Din Rail Mount.
40-6186	External power input terminal block	Power Supply source 120VAC/15V DC Din Rail Mount.
40-6169-2	Connector from Solar Charge controller	12V 21Ah lead-acid battery
40-6169-3	Connector from Solar Charge controller	12V 7Ah lead-acid battery
40-2342-1	Device Ground/Earthing	External Power Input Terminal Block

**Note:** Refer Section 4.3.1 for Power input cable glands and torque to be applied.



10.2.4 Wiring External DC Power for MIWIPCB

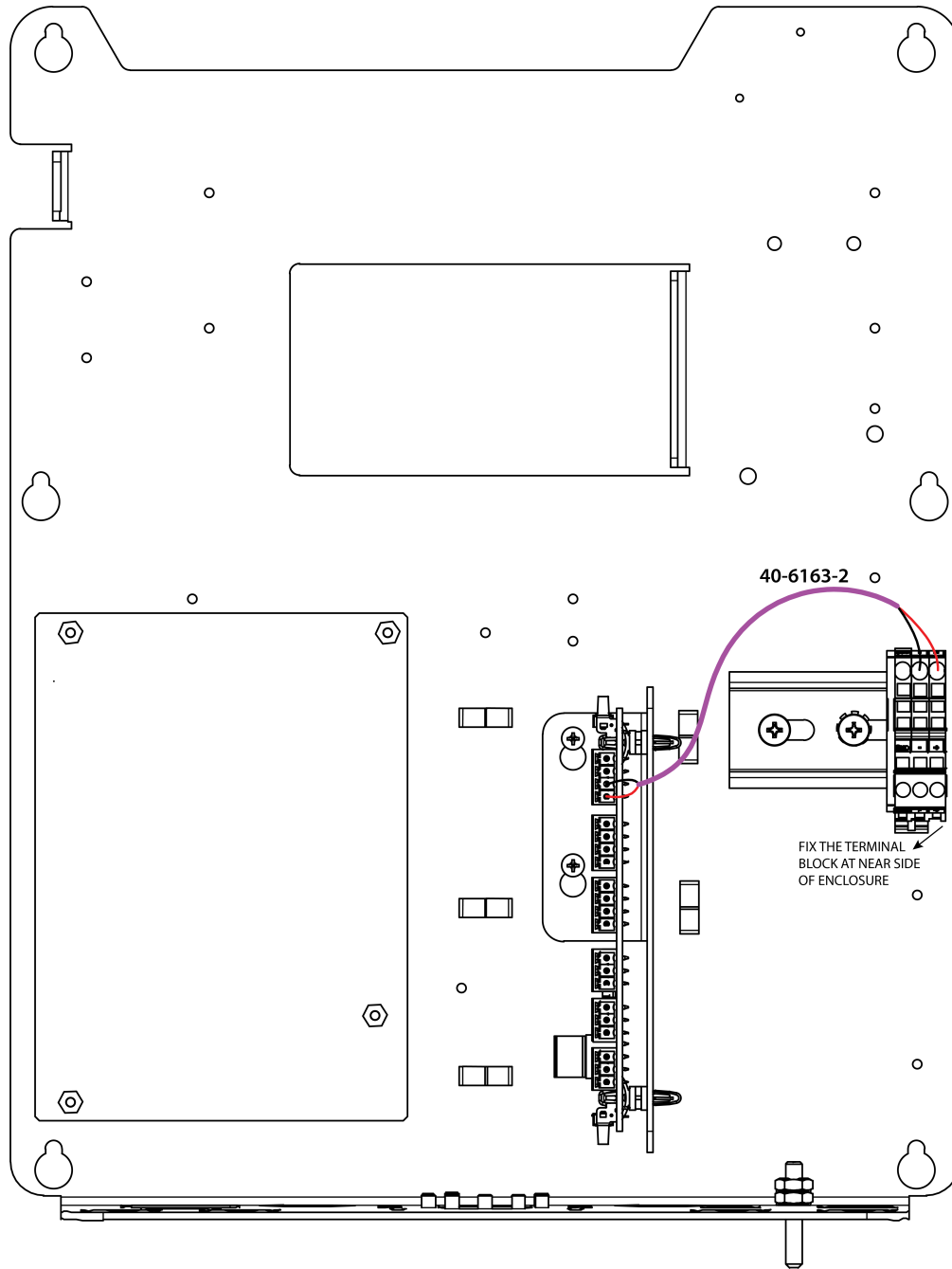

**Note:** The cable color code/pin mapping are for illustration purpose only.

**Figure 10-14:** Electrical Wiring - External 12V DC

Cable (Part#)	Connects	To
40-6163-2	External power input terminal block	Power Distribution Board P1 (DC-IN)

## 10.3 MIWI350 as Power or Communication Box

### 10.3.1 Barrier Connections

#### 10.3.1.1 With CloudLink MODEM

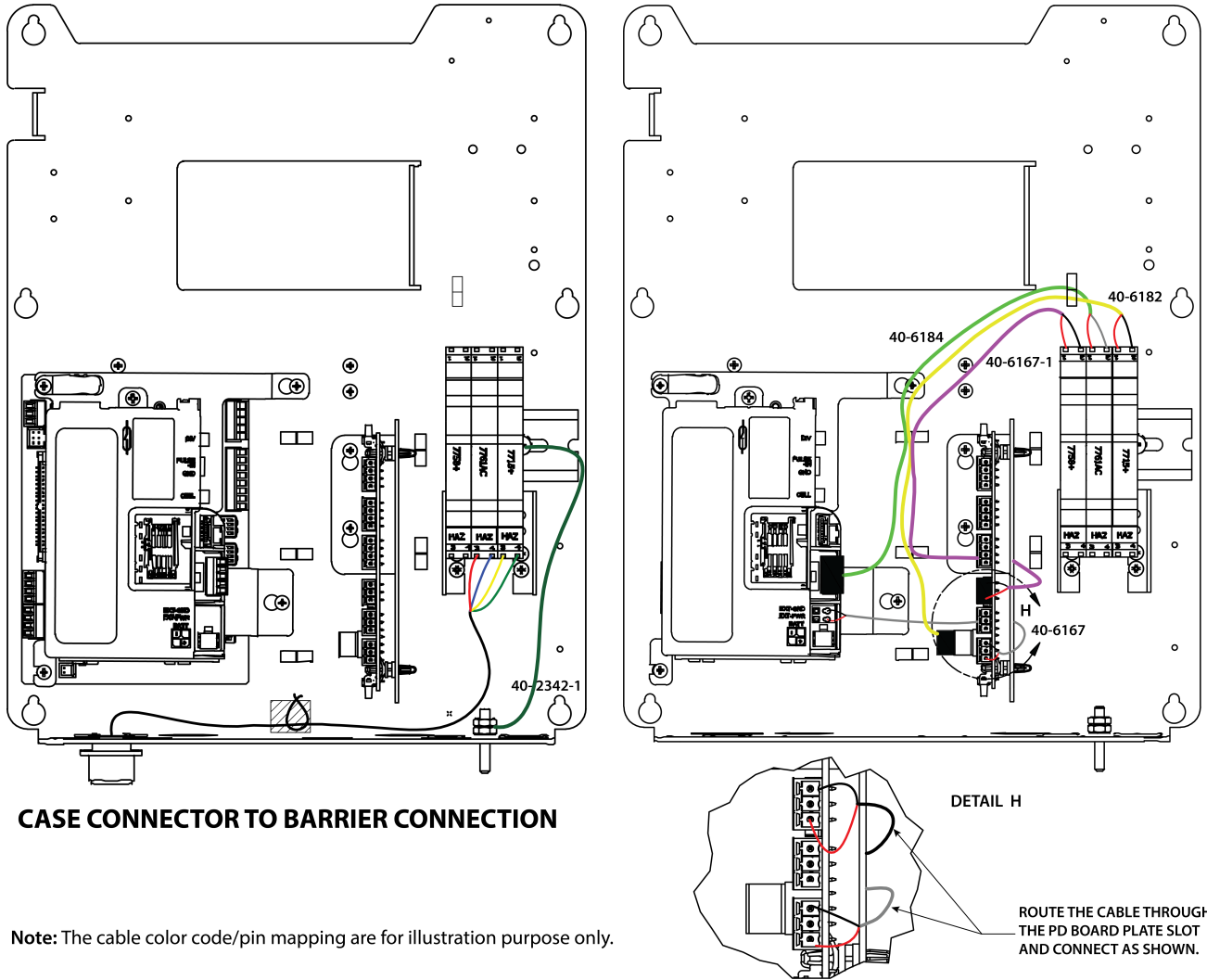

Figure 10-15: Internal Wiring - CloudLink R100 Connections

10.3.1.2 With CloudLink 4G M1 MODEM

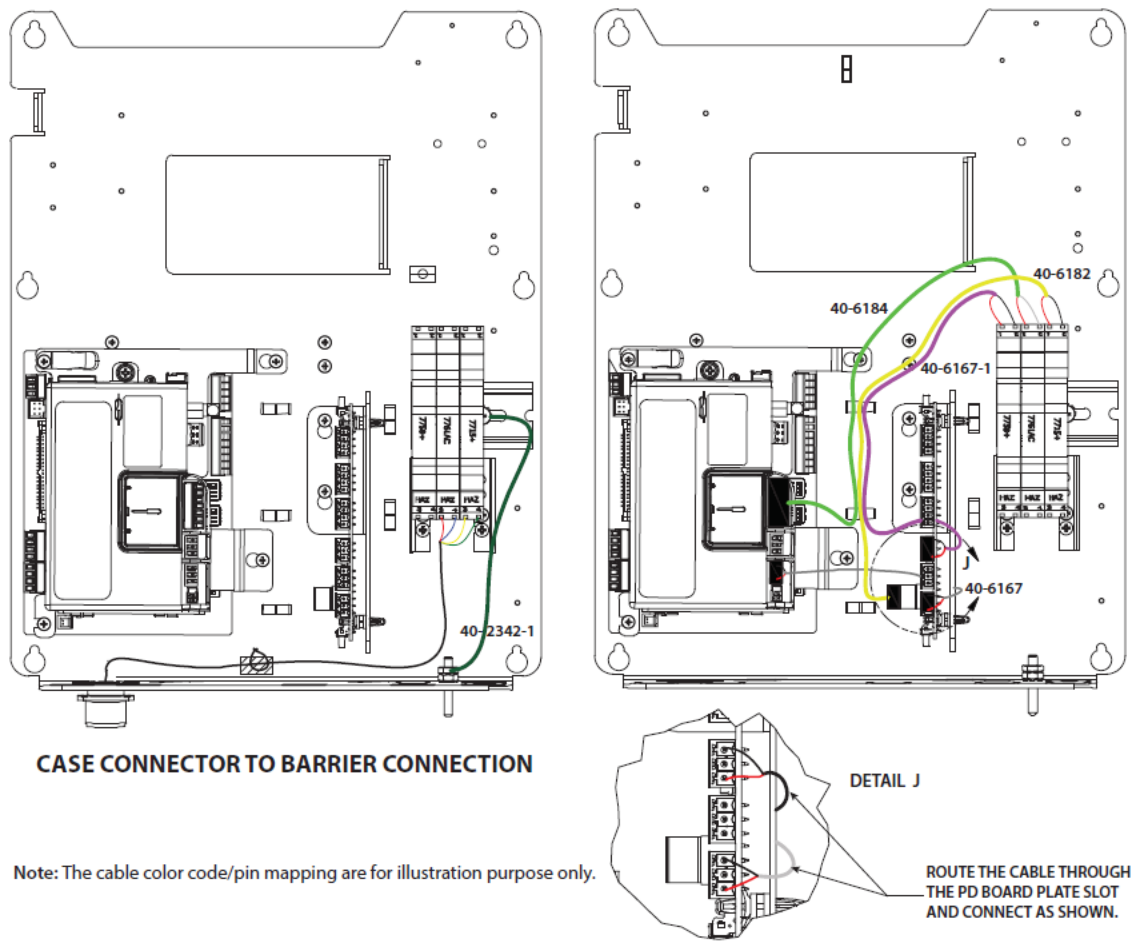

Figure 10-16: Internal Wiring - CloudLink R110 Connections

Cable (Part#)	Connects	To
40-6167	EXT POWER - CloudLink MODEM	Power Distribution Board P6
40-6167-1	Power Distribution Board P4	Power Barrier
40-6182	Power Distribution Board P11	Pulse Barrier
40-6184	CloudLink MODEM	Serial Barrier
40-2342-1	Device Ground / Earthing	Serial Barrier

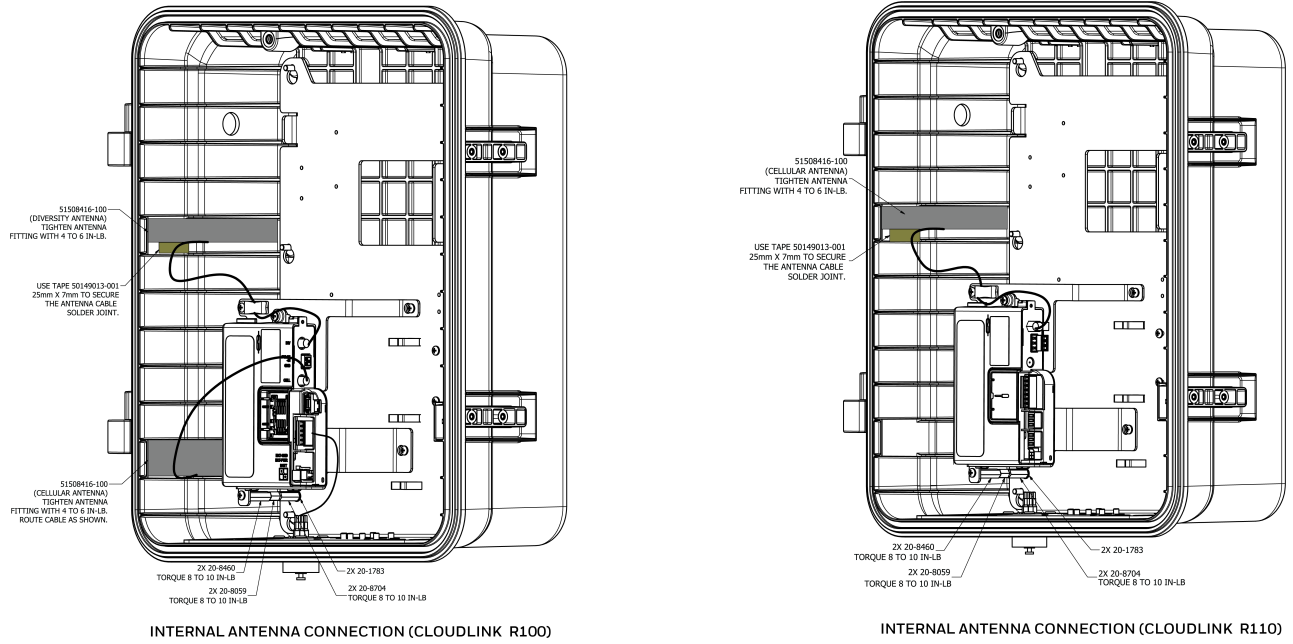
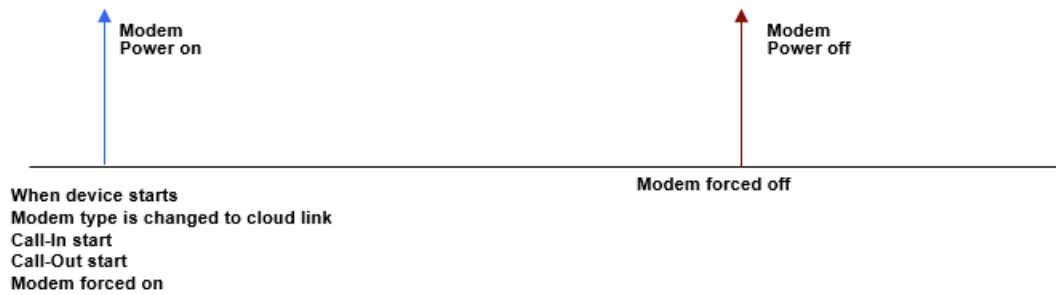

Figure 10-17: Internal Antenna connection (Cloudlink R100)

**Note:** For 'Ready for CloudLink MODEM' option, all necessary cables and fasteners will be provided except CloudLink MODEM.

**Modem Type Cloud link (i1458 = Cloud link)**

1. In any configuration, the modem is always connected to the P6 connector on the PD board.
2. When the modem type is set to "CloudLink," the EC350 will not control the modem power and the modem is always powered on.
3. If we want to use CloudLink as on-demand power on (when call in and call out), we must configure i1458 as others.



**Note:** Modem type CloudLink is applicable for CloudLink modem and CloudLink 4GM1 modem.

10.3.1.3 With RV50/RV50X/RV55 MODEM

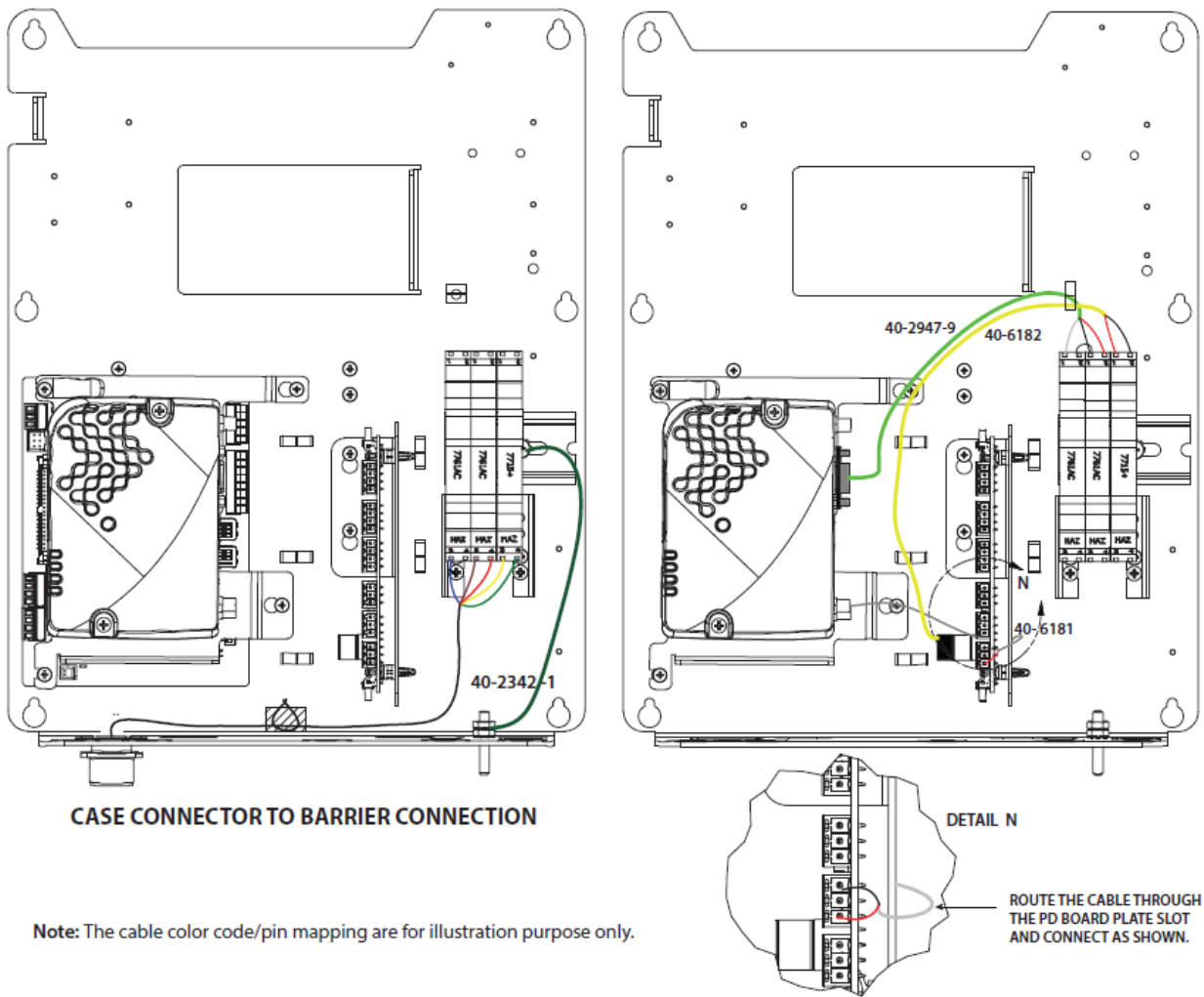

Figure 10-18: Internal Wiring - RV50/RV50X/RV55 MODEM Connections

Cable (Part#)	Connects	To
40-2947-9	RV50/RV50X/RV55 MODEM	Serial Barrier
40-6167-1	Power Distribution Board P4	Power Barrier
40-6181	RV50/RV50X/RV55 MODEM	Power Distribution Board P6
40-6182	Power Distribution Board P11	Pulse Barrier
40-2342-1	Device Ground/Earthing	Serial Barrier

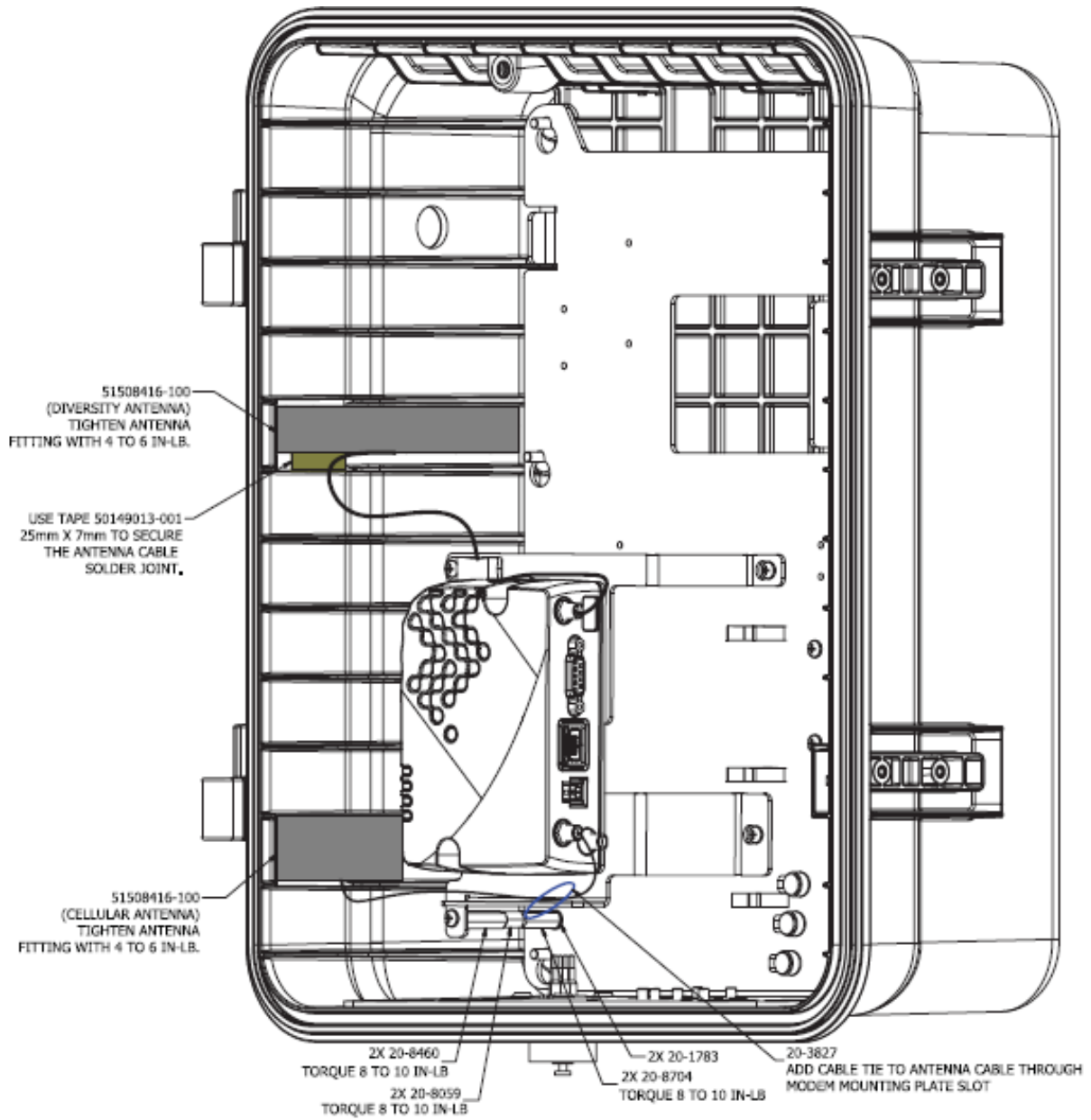

Figure 10-19: INTERNAL ANTENNA CONNECTION (RV50/RV50X/RV55)

**Note:** For 'Ready for RV50/RV50X/RV55' option, all necessary cables and fasteners will be provided except RV50/RV50X/RV55 MODEM.

### Modem Type Others (i1458 = Others)

1. In any configuration, the modem is always connected to the P6 connector on the PD board.
2. When the modem type is set to "Others," the EC350 will control the modem power as listed below.

Modem power on

Call-In start

Call-Out start

Modem forced on

Modem power off

Call-In/Keep alive end

Call-Out end

Modem forced off

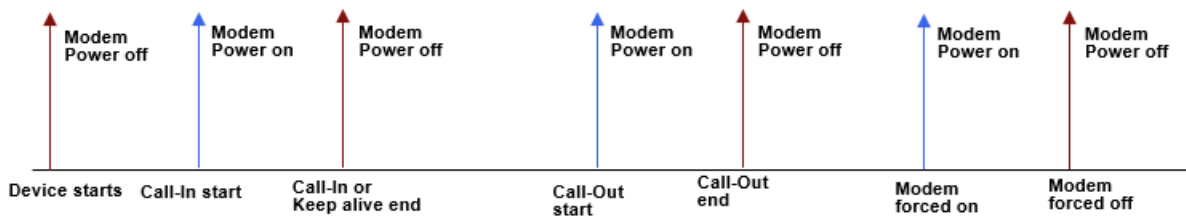

### 10.3.2 Terminal Block Connections

#### 10.3.2.1 With CloudLink MODEM

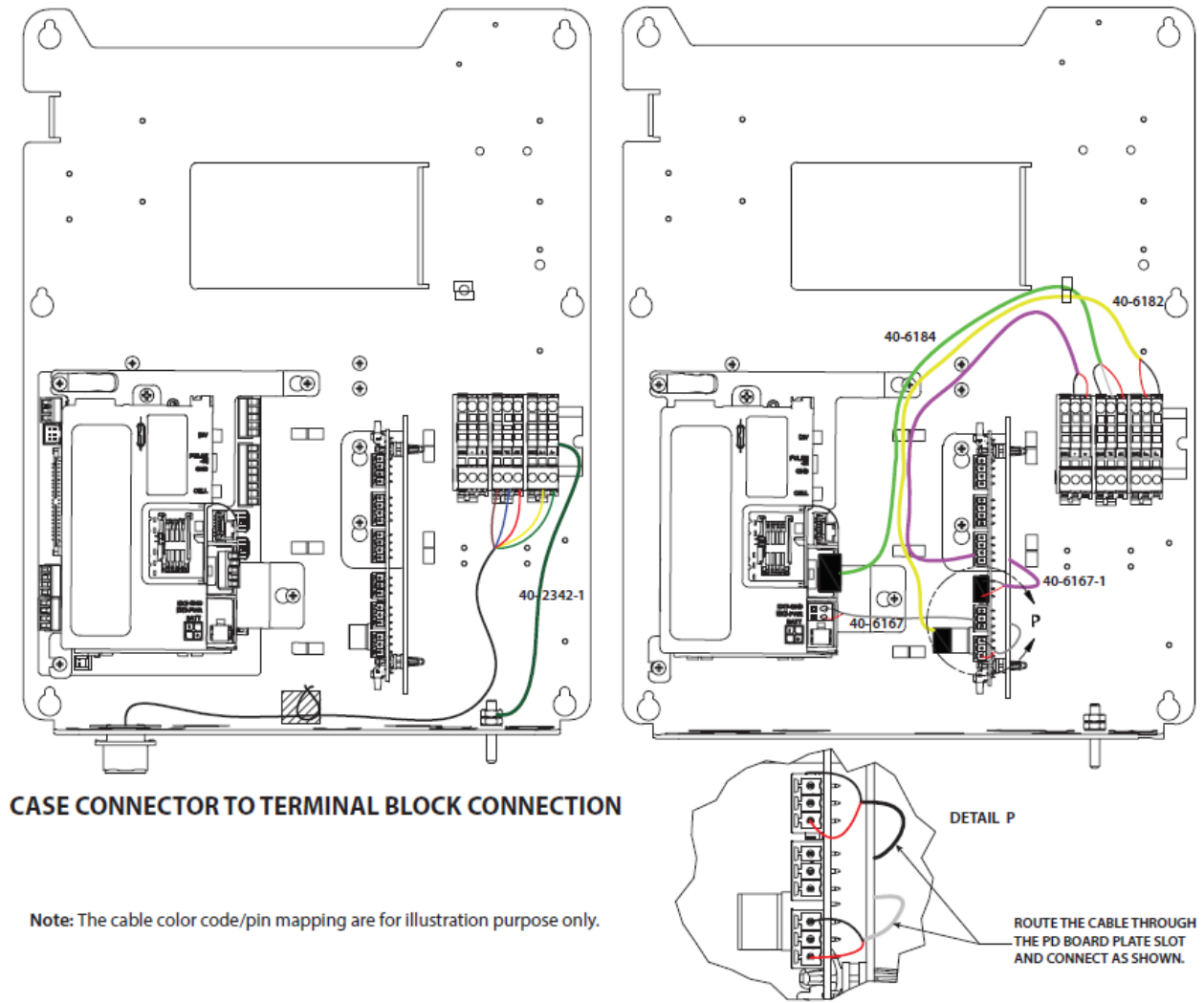

Figure 10-20: Internal Wiring - CloudLink R100 Connections



10.3.2.2 With CloudLink 4G M1 MODEM

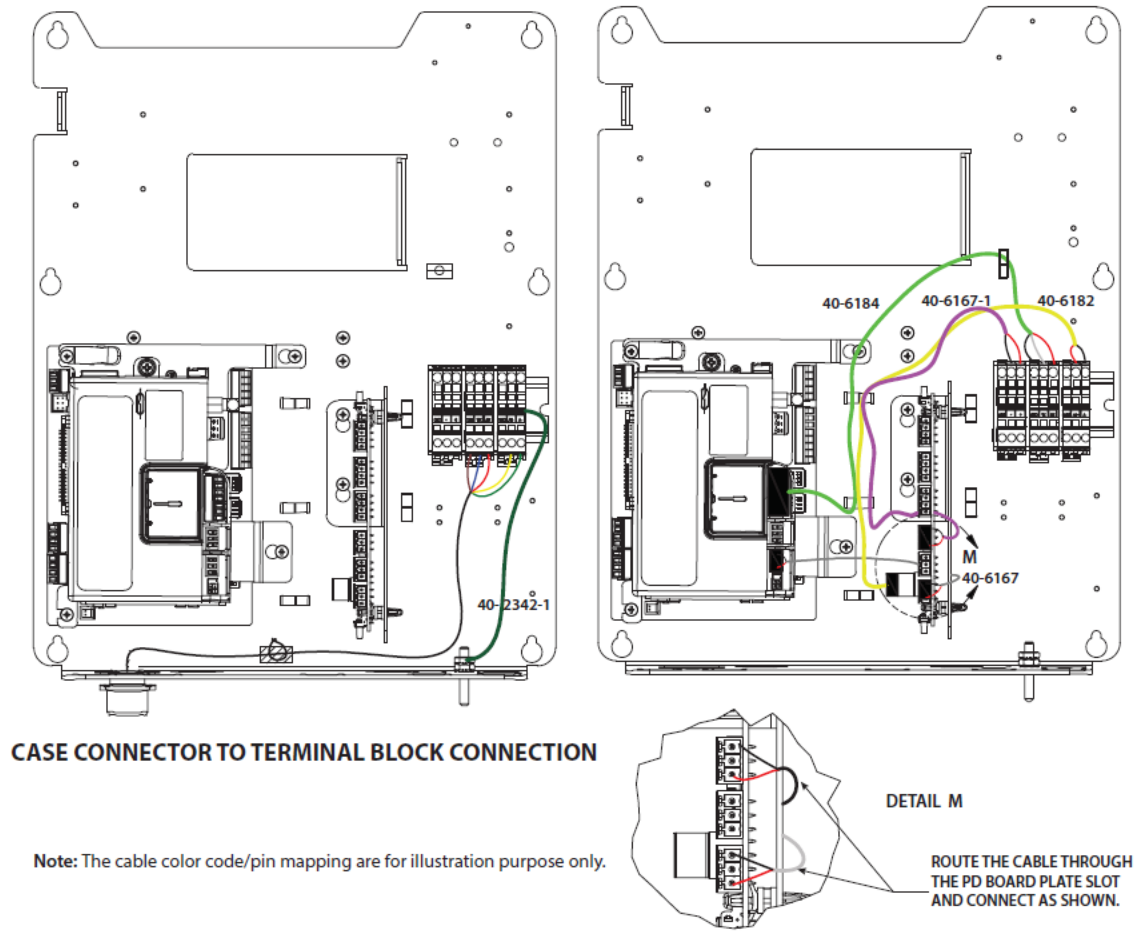

Figure 10-21: Internal Wiring - CloudLink 4G M1 MODEM Connections

Cable (Part#)	Connects	To
40-6167	EXT POWER - CloudLink MODEM	Power Distribution Board P6
40-6167-1	Power Distribution Board P4	Power Barrier
40-6182	Power Distribution Board P11	Pulse Barrier
40-6184	CloudLink MODEM	Serial Barrier
40-2342-1	Device Ground / Earthing	Serial Barrier

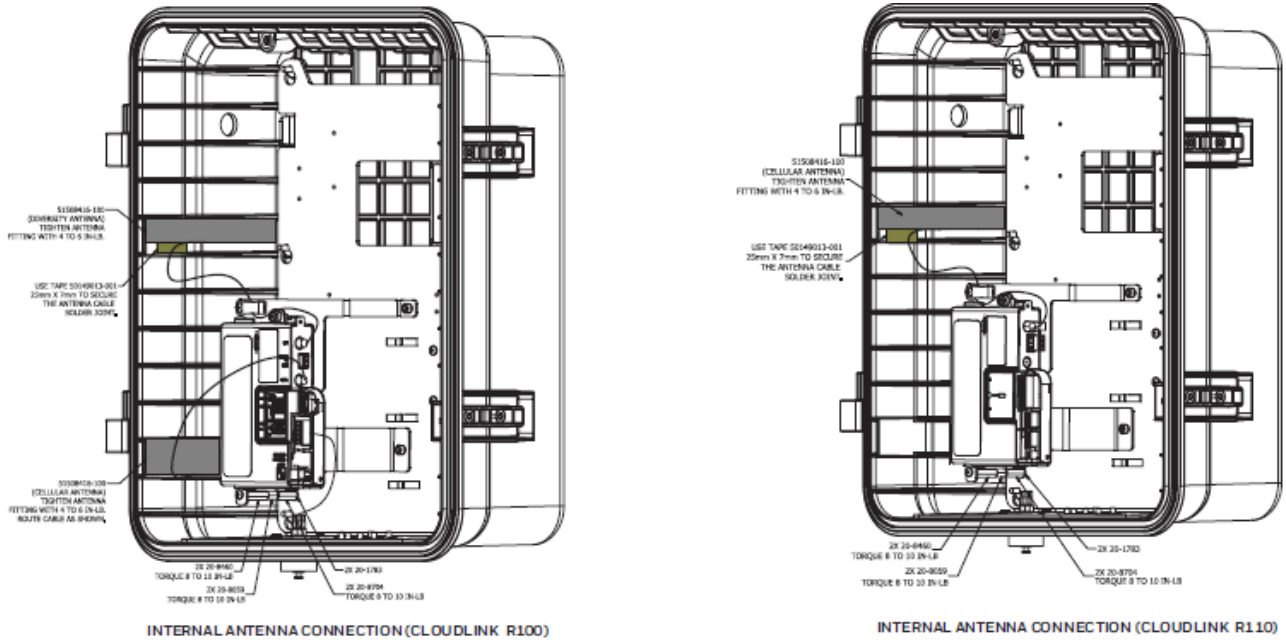

Figure 10-22: Internal Antenna connection(cloud link R100)

**Note:** For 'Ready for CloudLink MODEM' option, all necessary cables and fasteners will be provided except CloudLink MODEM.

10.3.2.3 With RV50/RV50X/RV55 MODEM

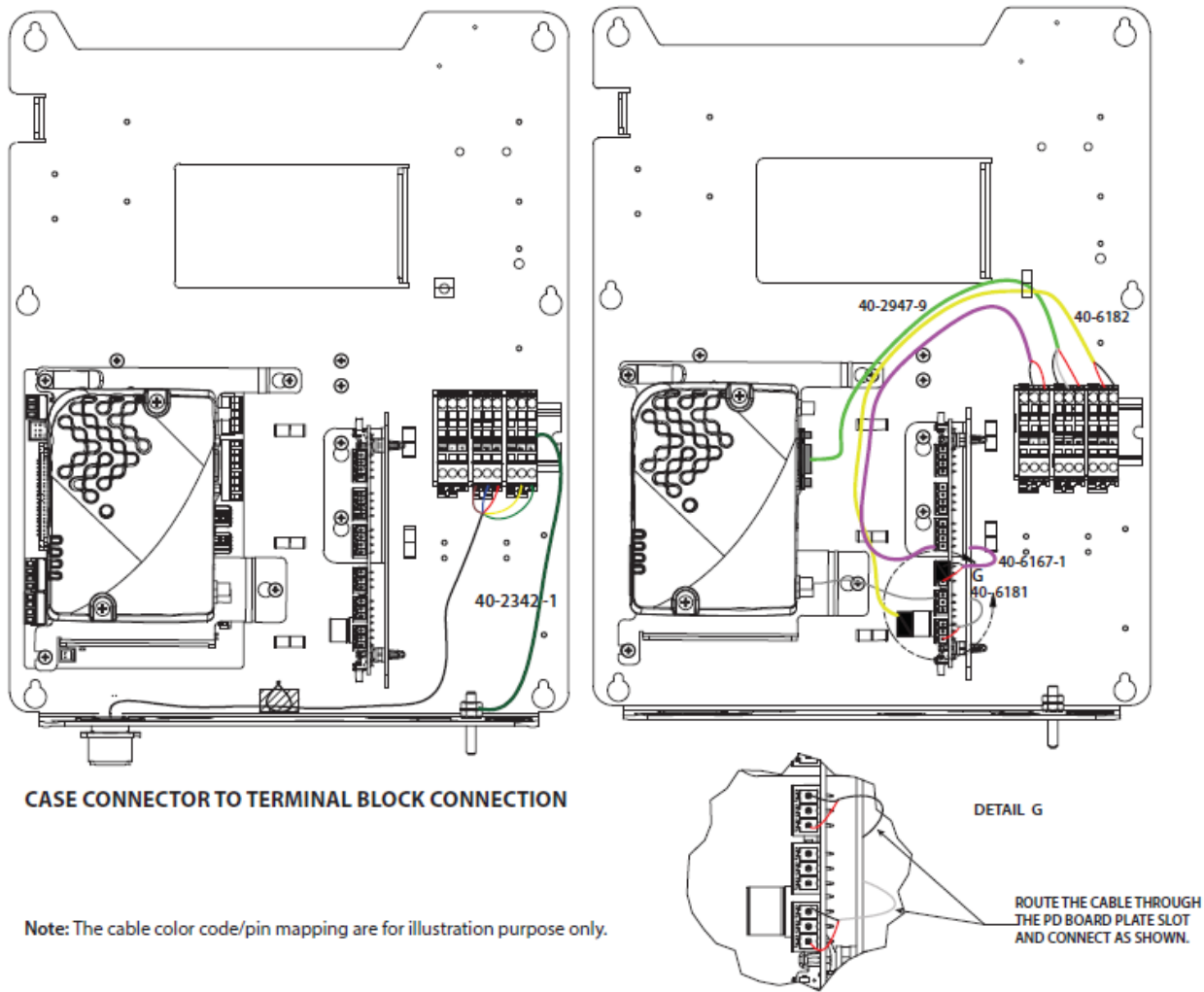

Figure 10-23: Internal Wiring - RV50/RV50X/RV55 MODEM Connections

Cable (Part#)	Connects	To
40-2947-9	RV50/RV50X/RV55 MODEM	Serial Barrier
40-6167-1	Power Distribution Board P4	Power Barrier
40-6181	RV50/RV50X/RV55 MODEM	Power Distribution Board P6
40-6182	Power Distribution Board P11	Pulse Barrier
40-2342-1	Device Ground/Earthing	Serial Barrier

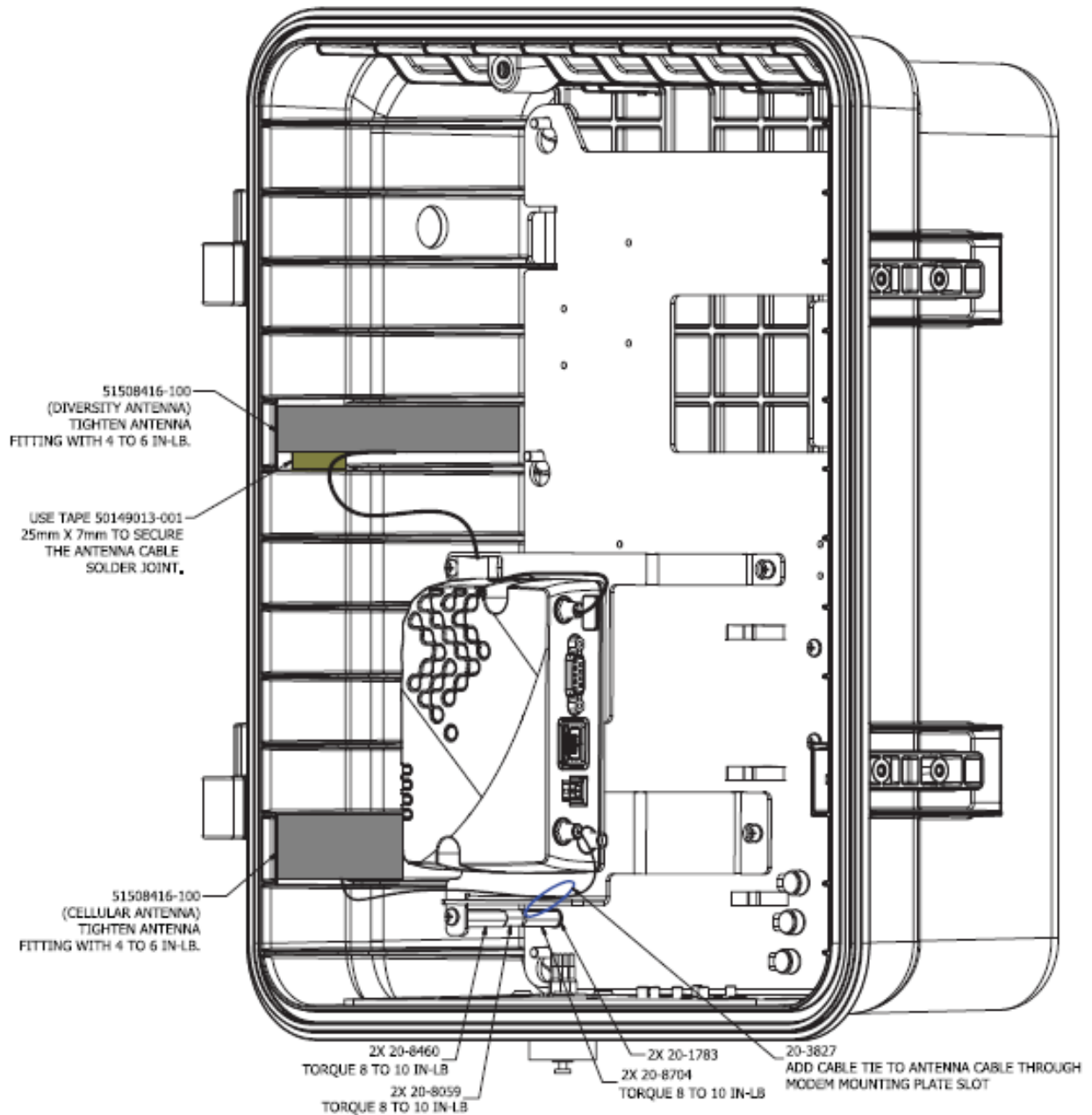

Figure 10-24: INTERNAL ANTENNA CONNECTION (RV50/RV50X/RV55)

**Note:** For 'Ready for RV50/RV50X/RV55' option, all necessary cables and fasteners will be provided except RV50/RV50X/RV55modem.

## 11 Configuration Software

User can use Honeywell MasterLink software application to configure and deploy a MIWI350 device.

MasterLink can be used to configure MIWI350 as:

- EC350/ERX350 Device
- Cellular MODEM (CLR100/CLR110 MODEM)
- EC350/ERX350 and Cellular MODEM as an Integrated Device

To learn more about MasterLink, EC350/ERX350, or CloudLink, refer to their respective user guides available on the Honeywell Process Website.

Product Name	Documentation Link
Honeywell MasterLink Software	<a href="#">MasterLink User Guide</a>
Honeywell EC350	<a href="#">EC350 User's Guide</a>
Honeywell ERX350	<a href="#">ERX350 Guide</a>
CloudLink 4G MODEM	<a href="#">CloudLink 4G MODEM User Guide</a>
CloudLink 4G M1 MODEM	<a href="#">CloudLink 4G M1 MODEM User guide</a>

## 12 350S Audit Trail Log support for CloudLink MODEM

With this feature support the user can configure the CloudLink items (item series 3000) in the Audit Trail records of the 350S to monitor the MODEM parameters.

There are certain string item limitations which have to be noted to understand the behavior of the AT log record readings.

The below table shows the list of string items as they are logged and the limitations in the AT logs:

ITEM NUMBER	ITEM DESCRIPTION	POSSIBLE VALUE	AUDIT TRAIL LOG VALUE
3004	CloudLink Radio IMEI number	19 character string	Last 8 characters
3029	CloudLink SIM Serial Number	20 character string	Last 8 characters
<i>Example:</i> If SIM Serial Number is 89619280910007075154 then, AT log value will be stored as <b>07075154</b> .			
3037	Primary IP Address for Alarm/Magnet Callin	IPv4 format	Last two blocks as float
3039	Alternate IP Address for Alarm/Magnet Callin	IPv4 format	Last two blocks as float
3042	CloudLink Ping Server IP/DNS	IPv4 format	Last two blocks as float
3045-3054	CloudLink White List IP Address 1 - 10	String	Last two blocks as float
3059	CloudLink IP Address	IPv4 format	Last two blocks as float
3095	CloudLink RUID1	String	Last 8 characters
3110	CloudLink Server Mode IP Address	IPv4 format	The last two blocks as float
<i>Example:</i> If the IP Address is 251 . 230 . 1 . 1 then, AT log value will be stored as <b>1 . 1</b>			
3125	CloudLink Last Call Cell ID	String	Decimal coded hex number and stores the last 8 digits
<i>Example:</i> If F42F is the CloudLink Cell ID then, F - 15; 4 - 04; 2 - 02; F - 15 so, AT log will be stored as <b>15040215</b> .			
3126	CloudLink Last Call Cell Location ID (Applicable for CLR100 only)	String	Decimal coded hex number and stores the last 8 digits
<i>Example:</i> If 13CB is the CloudLink Last Call Cell ID then,			

ITEM NUMBER	ITEM DESCRIPTION	POSSIBLE VALUE	AUDIT TRAIL LOG VALUE
1 - 01 3 - 03 C - 12 B - 11	so, AT log will be stored as <b>01031211</b> .		
3131	CloudLink Last Call Physical ID (Applicable for CLR100 only)	String	Decimal coded hex number and stores the last 8 digits
3133	CloudLink Last Call TAC	String	Convert to decimal
3139	CloudLink RUID2	String	Last 8 characters
<i>Example:</i> If CloudLink RUID is 8002473075 then, AT log value will be stored as <b>02473075</b> .			
3167	FOTA FTP Server IP	IPv4 format	Last two blocks as float

### Logging periodicity:

Using MasterLink configuring software, an instrument can be configured to contain as many as 5 independent logs, each with its own collection of item values and collection (sample) frequency. Each log can be configured to collect values for up to 20 items.

Logging Configuration when configured for less than an hour, the CL items will be refreshed on per hour basis only. Whereas, if the log frequency is configured to an interval more than an hour (daily or monthly) then, the log items will be observed with the same frequency (daily or monthly).

#### *For example:*

If log frequency is configured as **five** minutes then, CloudLink item values in the Logging configuration will be refreshed **ONLY** at the end of the hourly time period.

If frequency is set to **daily** (24 hours) then, the items in the logging configuration will be refreshed on daily basis.

### CloudLink AT Log Error Conditions

If EVC/ERX is unable to read CloudLink items based on Audit Trail Log configuration then, error codes get logged as per the below table:

CONDITION	ERROR DESCRIPTION
Unsupported CloudLink Item	Unsupported
MODEM configured is CNI2/Messenger/No MODEM	MODEM Mismatch
RD fails - Contention in Dial Out	Contention
CloudLink fails to response in spite of many retries	No Response
Port busy - all retries have failed	Busy

Example:

Site ID : 00000000 00000000 ; Site Name : Direct Connect ; Site Location : HYD

Log Date and Time	CloudLink Cellular Service Technology	CloudLink Advanced Low Battery Capacity Event	CloudLink Last read Time (HH MM SS)	CloudLink Last read Date (MM-DD-YY)
8/12/2020 08:00:00	Unsupported	Unsupported	07 59 34	08-12-20
8/12/2020 09:00:00	Unsupported	Unsupported	08 59 34	08-12-20
8/12/2020 10:00:00	Unsupported	Unsupported	09 59 34	08-12-20
8/12/2020 11:00:00	Unsupported	Unsupported	10 59 34	08-12-20
8/12/2020 12:00:00	Unsupported	Unsupported	11 59 34	08-12-20

In the above example, CL Cellular Service Technology and Low Battery Capacity Event items are not available on the connected MODEM so, **Unsupported** error code is displayed.

**Note:** *There is a limitation with these error codes on the date and time items. No error codes will be populated when the device fails to read the date and time item values.*



## 13 As Shipped Configuration Reload Procedure

User can reset the configured values in the device to 'As shipped configuration' by considering the following procedure:

**Note:** This As Shipped configuration reload procedure can be done ONLY on IrDA communication.

1. Establish an IrDA communication between 350S and MasterLink software application.
2. After a successful connection to the device, in the MasterLink software application window Click **View/Edit** on the Menu bar.
  - In the **View/Edit** page, read the item 1613 from Raw Item Access.
  - If the value is **2121488** then, there is a backup available and the user can proceed with the As Shipped configuration with the available back up.
  - But, if the value is not equal to **2121488** then, the device will give an unknown error.
  - User has to then initiate the configuration reload procedure as explained in the next step below.
  - User should have 'Modify' and 'Change' privileges to perform the As Shipped Configuration reload procedure. If not, the device will return an 'Access Disabled Error'.

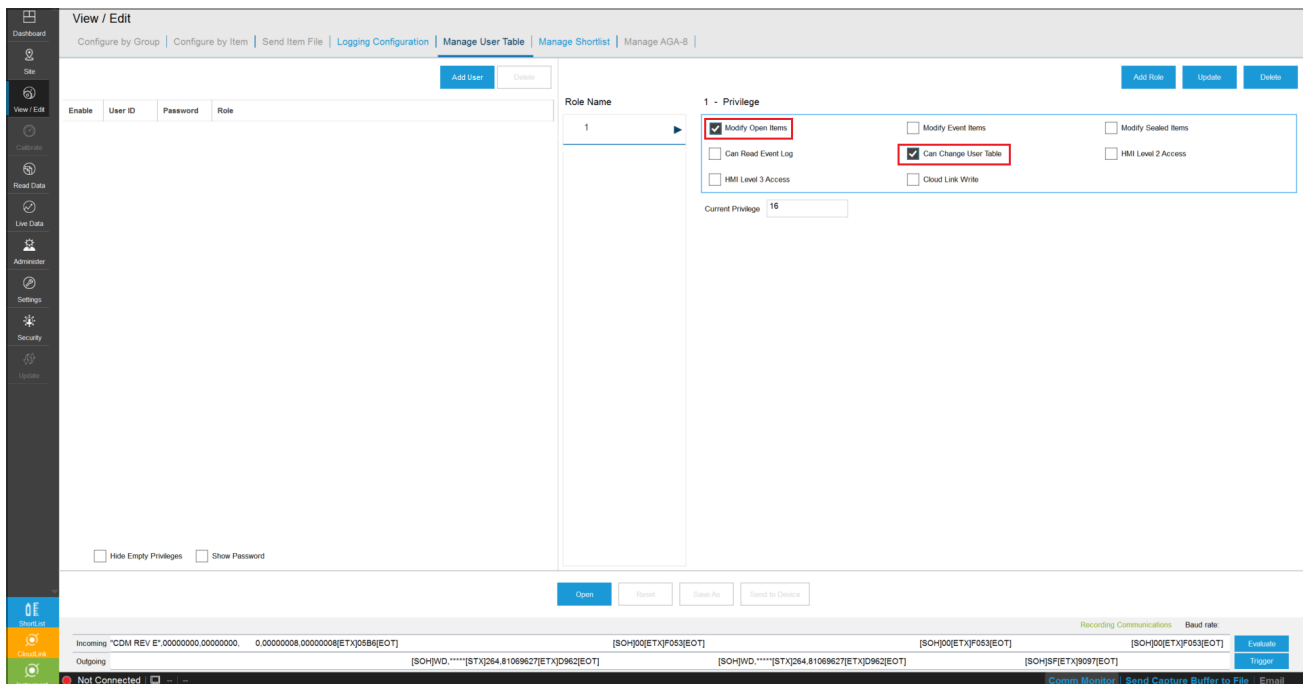

**Note:** A device under MC seal cannot be restored to As Shipped configuration.

Navigate to 'Configure by Group'. Click on 'Advanced Options' a new pop-up window 'Raw Item Access' appears.

Write the value "20139380" into item number 264 and wait for one minute. Then, Disconnect the device.

## 13 As Shipped Configuration Reload Procedure

Item Number	Description	Value	Unit
200	Site ICB Part 1		---
201	Site ICB Part 2		---
062	Unit Serial Number		---
1019	Main Board S/N		---
586	Sample Interval	60 Seconds	---
1190	Meter S/N		---
127	Instrument Type	EC 350 (14)	---
122	Firmware Version		---
1175	Firmware CRC		---
1177	Loader Version		---
1176	Loader CRC		---
1056	LCD Display On Time		---
1057	LCD Display Off Time		---
1163	Access Jumper Status	Unconnected	---
1062	Door Status	Door Closed	---
1044	Board Version		---
118	Reference Number 1		---
119	Reference Number 2		---
779	Calibration Mode	No Calibration	---
1396	Alarm Mask		---
1023	Alarm Items Disable		---

Device will re boot (Reboot will take approximately 1 min). After successful reboot, device goes back to the As Shipped Configuration defaults.

**Note:** Every item will be defaulted to As Shipped configuration but, run time dynamic items may get loaded with current values of the device. Also, the new items on Firmware upgrade (which are part of the new Firmware) will go back to the Firmware default values when user performs As Shipped Configuration restoration.

## 14 Orderable Kits

Description	Part#
U-BOLT GUILL 4 11/16 OD	20-9140-KIT
U-BOLT GUILL 2 7/16 OD 2 IN	20-9141-KIT-2
U-BOLT GUILL 3 11/16 OD 3 IN	20-9142-KIT-2
CASE CONN COVER MIWI350	22-2963-3-KIT
GROUNDING MIWI350	22-3102-KIT
BREATHER MIWI350	22-3103-KIT
GASKET MIWI350	22-3112-KIT
METER CASE & DOOR EXT DISP ASSY MIWI350	22-3116-1-KIT
METER CASE & DOOR INT DISP ASSY MIWI350	22-3116-2-KIT
REMOTE CASE & DOOR EXT DISP ASSY MIWI350	22-3116-3-KIT
REMOTE CASE & DOOR INT DISP ASSY MIWI350	22-3116-4-KIT
IO BOARD FASTENERS MIWI350	22-3117-KIT
BATT BRACKET LEAD ACID MIWI350	22-3118-1-KIT
BATT BRACKET ALKALINE MIWI350	22-3118-2-KIT
POWER DISTRIBUTION BOARD MIWI350	22-3119-KIT
LATCH MIWI350	22-3125-KIT
EXT DISPLAY COVER MIWI350	22-3126-1-KIT
INTERNAL DISPLAY COVER MIWI350	22-3126-2-KIT
CORRECTED VOL. I/P SWITCH-MIWI350	22-3127-1-KIT
CORR.VOL. I/P SWITCH-REV FLOW MIWI350	22-3127-2-KIT
UNCORRECTED VOL I/P SWITCH MIWI350	22-3127-3-KIT
UNCORR.VOL. I/P SW REV FLOW MIWI350	22-3127-4-KIT
CASE CONN ASSY MIWI350	22-3128-KIT
3/8 STRAIN RELIEF WITH PLUG (NYLON) MIWI350	22-3129-KIT
1/2 STRAIN RELIEF FOR POWER MIWI350	22-3138-KIT
DIN RAIL WITH SCREWS MIWI350	22-3139-KIT
1/2 STRAIN RELIEFS MIWI350	22-3140-KIT
SUN SAVER ASSY FOR MIWI350	22-3148-KIT
7Ah BRACKET MIWI350	22-3149-KIT
REMOTE BRACKET MIWI350	22-3159-KIT
PORTABLE BRACKET MIWI350	22-3160-KIT

Description	Part#
KIT ALKALINE BATT BKT WITH CABLE MIWI350	22-3161-KIT
TEC POWER MIWI350	22-3162-KIT
SUPERCAP MIWI350	22-3163-KIT
BLIND PLUG MIWI350	22-3164-KIT
TC-111 STL CITY CONDUIT MIWI350	22-3165-KIT
CL4G BRACKET MIWI350	22-3168-1-KIT
RV50/RV50X/RV55 BRACKET MIWI350	22-3168-2-KIT
KIT AC PROTECTION COVER	22-3174-KIT
KIT, PE BOARD	22-3177-KIT
KIT, PE RETROFIT MIWI350	22-3178-KIT
KIT NEMA4 BREATHER NUT ASSY	22-3179-KIT
GROUND CABLE	40-2342-1-KIT
KIT ASSY CA & RES 2 OHM MIWI W/DIO&RES	40-4130-1-KIT
SMA TO N-FEMALE-ASM COAX RG174 22 IN	40-4507-1-KIT
DOOR ALARM MAGNET/SWITCH	40-5162-6-KIT
MPC CABLE, POWER DISTRIBUTION BOARD TO I/O BOARD	40-6158-KIT
KIT, POWER SUPPLY CABLE TEC TO PD BOARD	40-6163-2-KIT
POWER SUPPLY CABLE, POWER DISTRIBUTION BOARD- I/O BOARD	40-6164-KIT
POWER SUPPLY CABLE, POWER DISTRIBUTION BOARD-CL4G MODEM	40-6167-KIT
PWR SUPPLY CABLE, POWER DISTRIBUTION BOARD TO PWR BARRIER	40-6167-1-KIT
PWR SUPPLY CABLE, POWER DISTRIBUTION BOARD TO EXT. POWER	40-6167-2-KIT
SOLAR CHARGE CONTROLLER. LOAD O/P CABLE	40-6169-1-KIT
21Ah LEAD-ACID BATTERY CABLE	40-6169-2-KIT
7Ah LEAD-ACID BATTERY CABLE	40-6169-3-KIT
KIT, AC-DC CHARGE CTRL, LOAD O/P CABLE	40-6169-4-KIT
MAGNETIC SWITCH ASSY	40-6170-KIT
POWER SUPPLY CABLE, POWER DISTRIBUTION BOARD-RV50/RV50X/RV55 MODEM	40-6181-KIT
MPC CABLE, POWER DISTRIBUTION BOARD TO PULSE BARRIER	40-6182-KIT
KIT, CABLE, IO BOARD TO PRESSURE EXPANSION BOARD MIWI350	40-6188-KIT
9" TEMP PROBE W/ 6' SS CABLE W/ POLY COAT	40-143209075PVC-1-KIT
KIT, EX BREATHERS ASSY MIWI350	22-3072-KIT*
KIT, UN CORR SWITCH BOARD ASSY 206P	22-3073-KIT

Description	Part#
KIT, DISPLAY GASKET MIWI350	22-3074-KIT
KIT, EX PWR SUPPLY PRO TOP1 120W 12V WEIDMUELLER	22-3075-KIT*
KIT, MC COVER ASSY FOR I/O, MIWI350	22-3077-KIT
KIT, MC COVER ASSY FOR PE, MIWI350	22-3078-KIT
KIT, METAL GLAND 3/8 NPT	22-3079-KIT*
KIT, METAL GLAND 1/2 NPT	22-3080-KIT*
KIT, GASKET RUBBER AMP LOW TEMP	22-3081-KIT*
KIT, POWER SUPPLY WIRING 21 AH	40-6169-5-KIT*
KIT, POWER SUPPLY WIRING 7AH	40-6169-6-KIT*
KIT, REMOTE CASE & DOOR INT DISP ASSY EX	22-3116-5-KIT*

**Note:** \* Suitable for IECEx ZONE2 certified MIWI350 offerings/installations.

## Notes

### **For more information:**

To learn more about Honeywell's Smart Gas Metering Solutions, visit <https://process.honeywell.com> or contact your Honeywell Process Solutions representative.

### **Honeywell Process Solutions**

2101 Citywest Boulevard Houston, TX 77042 USA

855 251-7065 – United States & Canada | 302 669-4253 – Outside the United States