

Operating Instructions

Proline t-mass I 300

Thermal mass flowmeter
HART



- Make sure the document is stored in a safe place such that it is always available when working on or with the device.
- To avoid danger to individuals or the facility, read the "Basic safety instructions" section carefully, as well as all other safety instructions in the document that are specific to working procedures.
- The manufacturer reserves the right to modify technical data without prior notice. Your Endress+Hauser Sales Center will supply you with current information and updates to these instructions.

Table of contents

| | | | | | |
|----------|--|-----------|--|--|--|
| 1 | About this document | 6 | | | |
| 1.1 | Document function | 6 | | | |
| 1.2 | Symbols | 6 | | | |
| 1.2.1 | Safety symbols | 6 | | | |
| 1.2.2 | Electrical symbols | 6 | | | |
| 1.2.3 | Communication-specific symbols | 6 | | | |
| 1.2.4 | Tool symbols | 7 | | | |
| 1.2.5 | Symbols for certain types of information | 7 | | | |
| 1.2.6 | Symbols in graphics | 7 | | | |
| 1.3 | Documentation | 8 | | | |
| 1.3.1 | Document function | 8 | | | |
| 1.4 | Registered trademarks | 8 | | | |
| 2 | Safety instructions | 9 | | | |
| 2.1 | Requirements for the personnel | 9 | | | |
| 2.2 | Intended use | 9 | | | |
| 2.3 | Workplace safety | 10 | | | |
| 2.4 | Operational safety | 10 | | | |
| 2.5 | Product safety | 10 | | | |
| 2.6 | IT security | 11 | | | |
| 2.7 | Device-specific IT security | 11 | | | |
| 2.7.1 | Protecting access via hardware write protection | 11 | | | |
| 2.7.2 | Protecting access via a password | 11 | | | |
| 2.7.3 | Access via web server | 12 | | | |
| 2.7.4 | Access via service interface (CDI- RJ45) | 13 | | | |
| 3 | Product description | 14 | | | |
| 3.1 | Product design | 14 | | | |
| 4 | Incoming acceptance and product identification | 15 | | | |
| 4.1 | Incoming acceptance | 15 | | | |
| 4.2 | Product identification | 15 | | | |
| 4.2.1 | Transmitter nameplate | 16 | | | |
| 4.2.2 | Sensor nameplate | 17 | | | |
| 4.2.3 | Symbols on the device | 17 | | | |
| 4.3 | Storage and transport | 18 | | | |
| 4.3.1 | Storage conditions | 18 | | | |
| 4.3.2 | Transporting the product | 18 | | | |
| 4.3.3 | Packaging disposal | 18 | | | |
| 5 | Mounting | 19 | | | |
| 5.1 | Mounting requirements | 19 | | | |
| 5.1.1 | Installation position | 19 | | | |
| 5.1.2 | Environment and process requirements | 25 | | | |
| 5.1.3 | Special mounting instructions | 27 | | | |
| 5.2 | Mounting the measuring device | 28 | | | |
| 5.2.1 | Required tool | 28 | | | |
| 5.2.2 | Preparing the measuring device | 28 | | | |
| 5.2.3 | Mounting the measuring device | 28 | | | |
| 5.2.4 | Turning the transmitter housing | 30 | | | |
| 5.2.5 | Turning the display module | 31 | | | |
| 5.3 | Post-installation check | 32 | | | |
| 6 | Electrical connection | 33 | | | |
| 6.1 | Electrical safety | 33 | | | |
| 6.2 | Connecting requirements | 33 | | | |
| 6.2.1 | Required tools | 33 | | | |
| 6.2.2 | Requirements for connecting cable | 33 | | | |
| 6.2.3 | Terminal assignment | 36 | | | |
| 6.2.4 | Preparing the measuring device | 36 | | | |
| 6.3 | Connecting the measuring device | 36 | | | |
| 6.3.1 | Connecting the transmitter | 36 | | | |
| 6.3.2 | Connecting the remote display and operating module DKX001 | 39 | | | |
| 6.4 | Potential equalization | 39 | | | |
| 6.4.1 | Requirements | 39 | | | |
| 6.5 | Special connection instructions | 40 | | | |
| 6.5.1 | Connection examples | 40 | | | |
| 6.6 | Ensuring the degree of protection | 43 | | | |
| 6.7 | Post-connection check | 44 | | | |
| 7 | Operation options | 45 | | | |
| 7.1 | Overview of operation options | 45 | | | |
| 7.2 | Structure and function of the operating menu | 46 | | | |
| 7.2.1 | Structure of the operating menu | 46 | | | |
| 7.2.2 | Operating philosophy | 47 | | | |
| 7.3 | Access to operating menu via local display | 48 | | | |
| 7.3.1 | Operational display | 48 | | | |
| 7.3.2 | Navigation view | 50 | | | |
| 7.3.3 | Editing view | 52 | | | |
| 7.3.4 | Operating elements | 54 | | | |
| 7.3.5 | Opening the context menu | 54 | | | |
| 7.3.6 | Navigating and selecting from list | 56 | | | |
| 7.3.7 | Calling the parameter directly | 56 | | | |
| 7.3.8 | Calling up help text | 57 | | | |
| 7.3.9 | Changing the parameters | 57 | | | |
| 7.3.10 | User roles and related access authorization | 58 | | | |
| 7.3.11 | Disabling write protection via access code | 58 | | | |
| 7.3.12 | Enabling and disabling the keypad lock | 59 | | | |
| 7.4 | Access to operating menu via web browser | 59 | | | |
| 7.4.1 | Function range | 59 | | | |
| 7.4.2 | Requirements | 60 | | | |
| 7.4.3 | Establishing a connection | 61 | | | |
| 7.4.4 | Logging on | 63 | | | |
| 7.4.5 | User interface | 64 | | | |
| 7.4.6 | Disabling the Web server | 65 | | | |
| 7.4.7 | Logging out | 65 | | | |

| | | | | | |
|----------|--|-----------|-----------|---|------------|
| 7.5 | Access to the operating menu via the operating tool | 66 | 10 | Operation | 128 |
| 7.5.1 | Connecting the operating tool | 66 | 10.1 | Reading off the device locking status | 128 |
| 7.5.2 | Field Xpert SFX350, SFX370 | 69 | 10.2 | Adjusting the operating language | 128 |
| 7.5.3 | FieldCare | 69 | 10.3 | Configuring the display | 128 |
| 7.5.4 | DeviceCare | 71 | 10.4 | Reading off measured values | 128 |
| 7.5.5 | AMS Device Manager | 71 | 10.4.1 | Process variables | 129 |
| 7.5.6 | Field Communicator 475 | 72 | 10.4.2 | System values | 130 |
| 7.5.7 | SIMATIC PDM | 72 | 10.4.3 | "Totalizer" submenu | 130 |
| | | | 10.4.4 | "Input values" submenu | 131 |
| | | | 10.4.5 | Output values | 132 |
| 8 | System integration | 73 | 10.5 | Adapting the measuring device to the process conditions | 134 |
| 8.1 | Overview of device description files | 73 | 10.6 | Performing a totalizer reset | 134 |
| 8.1.1 | Current version data for the device | 73 | 10.6.1 | Function scope of "Control Totalizer" parameter | 135 |
| 8.1.2 | Operating tools | 73 | 10.6.2 | Function range of "Reset all totalizers" parameter | 135 |
| 8.2 | Measured variables via HART protocol | 73 | 10.7 | Displaying data logging | 135 |
| 8.2.1 | Device variables | 74 | | | |
| 8.3 | Other settings | 75 | 11 | Diagnostics and troubleshooting | 138 |
| 9 | Commissioning | 78 | 11.1 | General troubleshooting | 138 |
| 9.1 | Post-mounting and post-connection check | 78 | 11.2 | Diagnostic information via light emitting diodes | 141 |
| 9.2 | Switching on the measuring device | 78 | 11.2.1 | Transmitter | 141 |
| 9.3 | Setting the operating language | 78 | 11.3 | Diagnostic information on local display | 142 |
| 9.4 | Configuring the measuring device | 79 | 11.3.1 | Diagnostic message | 142 |
| 9.4.1 | Defining the tag name | 80 | 11.3.2 | Calling up remedial measures | 144 |
| 9.4.2 | Configuring the measurement mode | 80 | 11.4 | Diagnostic information in the web browser | 145 |
| 9.4.3 | Configuring reference conditions | 84 | 11.4.1 | Diagnostic options | 145 |
| 9.4.4 | Sensor adjustment | 85 | 11.4.2 | Calling up remedy information | 146 |
| 9.4.5 | Setting the system units | 86 | 11.5 | Diagnostic information in FieldCare or DeviceCare | 147 |
| 9.4.6 | Displaying the I/O configuration | 88 | 11.5.1 | Diagnostic options | 147 |
| 9.4.7 | Configuring the current input | 89 | 11.5.2 | Calling up remedy information | 148 |
| 9.4.8 | Configuring the status input | 90 | 11.6 | Adapting the diagnostic information | 149 |
| 9.4.9 | Configuring the current output | 91 | 11.6.1 | Adapting the diagnostic behavior | 149 |
| 9.4.10 | Configuring the pulse/frequency/switch output | 94 | 11.6.2 | Adapting the status signal | 149 |
| 9.4.11 | Configuring the relay output | 100 | 11.7 | Overview of diagnostic information | 151 |
| 9.4.12 | Configuring the local display | 101 | 11.8 | Pending diagnostic events | 155 |
| 9.4.13 | Configuring the low flow cut off | 104 | 11.9 | Diagnostic list | 155 |
| 9.5 | Advanced settings | 105 | 11.10 | Event logbook | 157 |
| 9.5.1 | Using the parameter to enter the access code | 105 | 11.10.1 | Reading out the event logbook | 157 |
| 9.5.2 | Configuring the totalizer | 105 | 11.10.2 | Filtering the event logbook | 157 |
| 9.5.3 | Carrying out additional display configurations | 107 | 11.10.3 | Overview of information events | 158 |
| 9.5.4 | WLAN configuration | 110 | 11.11 | Resetting the measuring device | 160 |
| 9.5.5 | Configuration management | 112 | 11.11.1 | Function range of "Device reset" parameter | 160 |
| 9.5.6 | Using parameters for device administration | 113 | 11.12 | Device information | 161 |
| 9.5.7 | In-situ adjustment | 115 | 11.13 | Firmware history | 163 |
| 9.6 | Configuration management | 121 | 12 | Maintenance | 164 |
| 9.6.1 | Function scope of the "Configuration management" parameter | 121 | 12.1 | Maintenance tasks | 164 |
| 9.7 | Simulation | 122 | 12.1.1 | Exterior cleaning | 164 |
| 9.8 | Protecting settings from unauthorized access | 124 | 12.1.2 | Sensing element cleaning | 164 |
| 9.8.1 | Write protection via access code | 124 | 12.1.3 | Recalibration | 165 |
| 9.8.2 | Write protection via write protection switch | 126 | 12.2 | Measuring and test equipment | 165 |
| | | | 12.3 | Endress+Hauser services | 165 |

| | | |
|--------------------|--|------------|
| 13 | Repair | 166 |
| 13.1 | General information | 166 |
| 13.1.1 | Repair and conversion concept | 166 |
| 13.1.2 | Notes for repair and conversion | 166 |
| 13.2 | Spare parts | 166 |
| 13.3 | Endress+Hauser services | 166 |
| 13.4 | Return | 166 |
| 13.5 | Disposal | 167 |
| 13.5.1 | Removing the measuring device | 167 |
| 13.5.2 | Disposing of the measuring device .. | 167 |
| 14 | Accessories | 168 |
| 14.1 | Device-specific accessories | 168 |
| 14.1.1 | For the transmitter | 168 |
| 14.1.2 | For the sensor | 169 |
| 14.2 | Communication-specific accessories | 170 |
| 14.3 | Service-specific accessories | 171 |
| 14.4 | System components | 171 |
| 15 | Technical data | 172 |
| 15.1 | Application | 172 |
| 15.2 | Function and system design | 172 |
| 15.3 | Input | 173 |
| 15.4 | Output | 178 |
| 15.5 | Power supply | 183 |
| 15.6 | Performance characteristics | 185 |
| 15.7 | Mounting | 186 |
| 15.8 | Environment | 187 |
| 15.9 | Process | 189 |
| 15.10 | Mechanical construction | 191 |
| 15.11 | Display and user interface | 194 |
| 15.12 | Certificates and approvals | 199 |
| 15.13 | Application packages | 202 |
| 15.14 | Accessories | 203 |
| 15.15 | Documentation | 203 |
| Index | 205 | |

1 About this document

1.1 Document function

These Operating Instructions contain all the information required in the various life cycle phases of the device: from product identification, incoming acceptance and storage, to installation, connection, operation and commissioning, through to troubleshooting, maintenance and disposal.

1.2 Symbols

1.2.1 Safety symbols

DANGER

This symbol alerts you to a dangerous situation. Failure to avoid this situation will result in serious or fatal injury.

WARNING

This symbol alerts you to a dangerous situation. Failure to avoid this situation can result in serious or fatal injury.





CAUTION

This symbol alerts you to a dangerous situation. Failure to avoid this situation can result in minor or medium injury.



NOTICE



This symbol contains information on procedures and other facts which do not result in personal injury.

1.2.2 Electrical symbols



| Symbol | Meaning |
|---|--|
|  | Direct current |
|  | Alternating current |
|  | Direct current and alternating current |
|  | Ground connection A grounded terminal which, as far as the operator is concerned, is grounded via a grounding system. |
|  | Potential equalization connection (PE: protective earth) Ground terminals that must be connected to ground prior to establishing any other connections. The ground terminals are located on the interior and exterior of the device: <ul style="list-style-type: none"> ▪ Interior ground terminal: potential equalization is connected to the supply network. ▪ Exterior ground terminal: device is connected to the plant grounding system. |

1.2.3 Communication-specific symbols













| Symbol | Meaning |
|---|---|
|  | Wireless Local Area Network (WLAN) Communication via a wireless, local network. |
|  | LED Light emitting diode is off. |

| Symbol | Meaning |
|---|---|
|  | LED Light emitting diode is on. |
|  | LED Light emitting diode is flashing. |

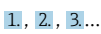

1.2.4 Tool symbols



| Symbol | Meaning |
|---|------------------------|
|  | Flat-blade screwdriver |
|  | Allen key |
|  | Open-ended wrench |

1.2.5 Symbols for certain types of information

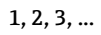
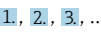
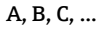
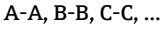
| Symbol | Meaning |
|---|--|
|  | Permitted Procedures, processes or actions that are permitted. |
|  | Preferred Procedures, processes or actions that are preferred. |
|  | Forbidden Procedures, processes or actions that are forbidden. |
|  | Tip Indicates additional information. |
|  | Reference to documentation |
|  | Reference to page |
|  | Reference to graphic |
|  | Notice or individual step to be observed |
|  | Series of steps |
|  | Result of a step |
|  | Help in the event of a problem |
|  | Visual inspection |

1.2.6 Symbols in graphics

| Symbol | Meaning |
|---|-----------------|
|  | Item numbers |
|  | Series of steps |
|  | Views |
|  | Sections |
|  | Hazardous area |

| Symbol | Meaning |
|---|--------------------------------|
|  | Safe area (non-hazardous area) |
|  | Flow direction |

1.3 Documentation

 For an overview of the scope of the associated Technical Documentation, refer to the following:

- *Device Viewer* (www.endress.com/deviceviewer): Enter the serial number from the nameplate
- *Endress+Hauser Operations app*: Enter serial number from nameplate or scan matrix code on nameplate.

1.3.1 Document function

The following documentation may be available depending on the version ordered:

| Document type | Purpose and content of the document |
|--|---|
| Technical Information (TI) | Planning aid for your device The document contains all the technical data on the device and provides an overview of the accessories and other products that can be ordered for the device. |
| Brief Operating Instructions (KA) | Guide that takes you quickly to the 1st measured value The Brief Operating Instructions contain all the essential information from incoming acceptance to initial commissioning. |
| Operating Instructions (BA) | Your reference document The Operating Instructions contain all the information that is required in the various phases of the life cycle of the device: from product identification, incoming acceptance and storage, to mounting, connection, operation and commissioning through to troubleshooting, maintenance and disposal. |
| Description of Device Parameters (GP) | Reference for your parameters The document provides a detailed explanation of each individual parameter. The description is aimed at those who work with the device over the entire life cycle and perform specific configurations. |
| Safety Instructions (XA) | Depending on the approval, safety instructions for electrical equipment in hazardous areas are also supplied with the device. The Safety Instructions are an integral part of the Operating Instructions.  Information on the Safety Instructions (XA) relevant to the device is provided on the nameplate. |
| Supplementary device-dependent documentation (SD/FY) | Always comply strictly with the instructions in the relevant supplementary documentation. The supplementary documentation is an integral part of the device documentation. |

1.4 Registered trademarks

HART®

Registered trademark of the FieldComm Group, Austin, Texas, USA

2 Safety instructions

2.1 Requirements for the personnel

The personnel for installation, commissioning, diagnostics and maintenance must fulfill the following requirements:

- ▶ Trained, qualified specialists must have a relevant qualification for this specific function and task.
- ▶ Are authorized by the plant owner/operator.
- ▶ Are familiar with federal/national regulations.
- ▶ Before starting work, read and understand the instructions in the manual and supplementary documentation as well as the certificates (depending on the application).
- ▶ Follow instructions and comply with basic conditions.

The operating personnel must fulfill the following requirements:

- ▶ Are instructed and authorized according to the requirements of the task by the facility's owner-operator.
- ▶ Follow the instructions in this manual.

2.2 Intended use

Application and media

The measuring device described in this manual is intended only for the flow measurement of gases.

Depending on the version ordered, the measuring device can also measure potentially explosive, flammable, poisonous and oxidizing media.

Measuring devices for use in hazardous areas or where the process pressures pose an increased risk, are marked specifically on the nameplate.

To ensure that the measuring device remains in proper condition for the operation time:

- ▶ Use the measuring device only for media to which the process-wetted materials are sufficiently resistant.
- ▶ Keep within the specified pressure and temperature range.
- ▶ Only use the measuring device in full compliance with the data on the nameplate and the general conditions listed in the Operating Instructions and supplementary documentation.
- ▶ Check the nameplate to verify if the device ordered can be put to its intended use in the hazardous area (e.g. explosion protection, pressure equipment safety).
- ▶ If the ambient temperature of the measuring device is outside the atmospheric range, it is absolutely essential to comply with the relevant basic conditions as specified →  8 in the device documentation.
- ▶ Protect the measuring device permanently against corrosion from environmental influences.

Incorrect use

Non-designated use can compromise safety. The manufacturer is not liable for damage caused by improper or non-designated use.

WARNING

Danger of breakage due to corrosive or abrasive fluids and ambient conditions!

- ▶ Verify the compatibility of the process fluid with the sensor material.
- ▶ Ensure the resistance of all fluid-wetted materials in the process.
- ▶ Keep within the specified pressure and temperature range.

NOTICE**Verification for borderline cases:**

- ▶ For special fluids and fluids for cleaning, Endress+Hauser is glad to provide assistance in verifying the corrosion resistance of fluid-wetted materials, but does not accept any warranty or liability as minute changes in the temperature, concentration or level of contamination in the process can alter the corrosion resistance properties.

⚠ WARNING**Injury from sensor being ejected!**

- ▶ The sensor gland should be opened only when in an unpressurized state.

NOTICE**Penetration of dust and moisture when the transmitter housing is opened.**

- ▶ Only open the transmitter housing briefly, ensuring that no dust or moisture enters the housing.

Residual risks**⚠ CAUTION****The electronics and the medium may cause the surfaces to heat up or freeze. Risk of burns or frostbite!**

- ▶ Mount suitable touch protection.

2.3 Workplace safety

When working on and with the device:

- ▶ Wear the required personal protective equipment as per national regulations.

2.4 Operational safety

Damage to the device!

- ▶ Operate the device in proper technical condition and fail-safe condition only.
- ▶ The operator is responsible for the interference-free operation of the device.

Modifications to the device

Unauthorized modifications to the device are not permitted and can lead to unforeseeable dangers!

- ▶ If modifications are nevertheless required, consult with the manufacturer.

Repair

To ensure continued operational safety and reliability:

- ▶ Carry out repairs on the device only if they are expressly permitted.
- ▶ Observe federal/national regulations pertaining to the repair of an electrical device.
- ▶ Use only original spare parts and accessories.

2.5 Product safety

This measuring device is designed in accordance with good engineering practice to meet state-of-the-art safety requirements, has been tested, and left the factory in a condition in which it is safe to operate.

It meets general safety standards and legal requirements. It also complies with the EU directives listed in the device-specific EU Declaration of Conformity. The manufacturer confirms this by affixing the CE mark to the device..





2.6 IT security

Our warranty is valid only if the product is installed and used as described in the Operating Instructions. The product is equipped with security mechanisms to protect it against any inadvertent changes to the settings.

IT security measures, which provide additional protection for the product and associated data transfer, must be implemented by the operators themselves in line with their security standards.

2.7 Device-specific IT security

The device offers a range of specific functions to support protective measures on the operator's side. These functions can be configured by the user and guarantee greater in-operation safety if used correctly. The following list provides an overview of the most important functions:

| Function/interface | Factory setting | Recommendation |
|---|--------------------|---|
| Write protection via hardware write protection switch →  11 | Not enabled | On an individual basis following risk assessment |
| Access code (also applies to web server login or FieldCare connection) →  12 | Not enabled (0000) | Assign a customized access code during commissioning |
| WLAN (order option in display module) | Enabled | On an individual basis following risk assessment |
| WLAN security mode | Enabled (WPA2-PSK) | Do not change |
| WLAN passphrase (Password) →  12 | Serial number | Assign an individual WLAN passphrase during commissioning |
| WLAN mode | Access point | On an individual basis following risk assessment |
| Web server →  12 | Enabled | On an individual basis following risk assessment |
| CDI-RJ45 service interface →  13 | – | On an individual basis following risk assessment |

2.7.1 Protecting access via hardware write protection

Write access to the parameters of the device via the local display, web browser or operating tool (e.g. FieldCare, DeviceCare) can be disabled via a write protection switch (DIP switch on the main electronics module). When hardware write protection is enabled, only read access to the parameters is possible.

Hardware write protection is disabled when the device is delivered →  126.

2.7.2 Protecting access via a password

Different passwords are available to protect write access to the device parameters or access to the device via the WLAN interface.

- **User-specific access code**
Protect write access to the device parameters via the local display, web browser or operating tool (e.g. FieldCare, DeviceCare). Access authorization is clearly regulated through the use of a user-specific access code.
- **WLAN passphrase**
The network key protects a connection between an operating unit (e.g. notebook or tablet) and the device via the WLAN interface which can be ordered as an option.
- **Infrastructure mode**
When the device is operated in infrastructure mode, the WLAN passphrase corresponds to the WLAN passphrase configured on the operator side.

User-specific access code

Write access to the device parameters via the local display, web browser or operating tool (e.g. FieldCare, DeviceCare) can be protected by the modifiable, user-specific access code (→  124).

When the device is delivered, the device does not have an access code and is equivalent to 0000 (open).

WLAN passphrase: Operation as WLAN access point

A connection between an operating unit (e.g. notebook or tablet) and the device via the WLAN interface (→  68), which can be ordered as an optional extra, is protected by the network key. The WLAN authentication of the network key complies with the IEEE 802.11 standard.

When the device is delivered, the network key is pre-defined depending on the device. It can be changed via the **WLAN settings** submenu in the **WLAN passphrase** parameter (→  111).

Infrastructure mode

A connection between the device and WLAN access point is protected by means of an SSID and passphrase on the system side. Please contact the relevant system administrator for access.

General notes on the use of passwords



- The access code and network key supplied with the device should be changed during commissioning for safety reasons.
- Follow the general rules for generating a secure password when defining and managing the access code and network key.
- The user is responsible for the management and careful handling of the access code and network key.
- For information on configuring the access code or on what to do if you lose the password, for example, see "Write protection via access code" →  124.

2.7.3 Access via web server

The integrated web server can be used to operate and configure the device via a web browser →  59. The connection is established via the service interface (CDI-RJ45) or the WLAN interface.

The web server is enabled when the device is delivered. The web server can be disabled via the **Web server functionality** parameter if necessary (e.g. after commissioning).

The device and status information can be hidden on the login page. This prevents unauthorized access to the information.

 For detailed information on device parameters, see: "Description of Device Parameters" document →  203.

2.7.4 Access via service interface (CDI-RJ45)

The device can be connected to a network via the service interface (CDI-RJ45). Device-specific functions guarantee the secure operation of the device in a network.

The use of relevant industrial standards and guidelines that have been defined by national and international safety committees, such as IEC/ISA62443 or the IEEE, is recommended. This includes organizational security measures such as the assignment of access authorization as well as technical measures such as network segmentation.



Transmitters with an Ex de approval may not be connected via the service interface (CDI-RJ45)!

Order code for "Approval", options (Ex de): BB, C2, GB, MB, NB

3 Product description

The device consists of a transmitter and a sensor.

The device is available as a compact version:

The transmitter and sensor form a mechanical unit.

3.1 Product design

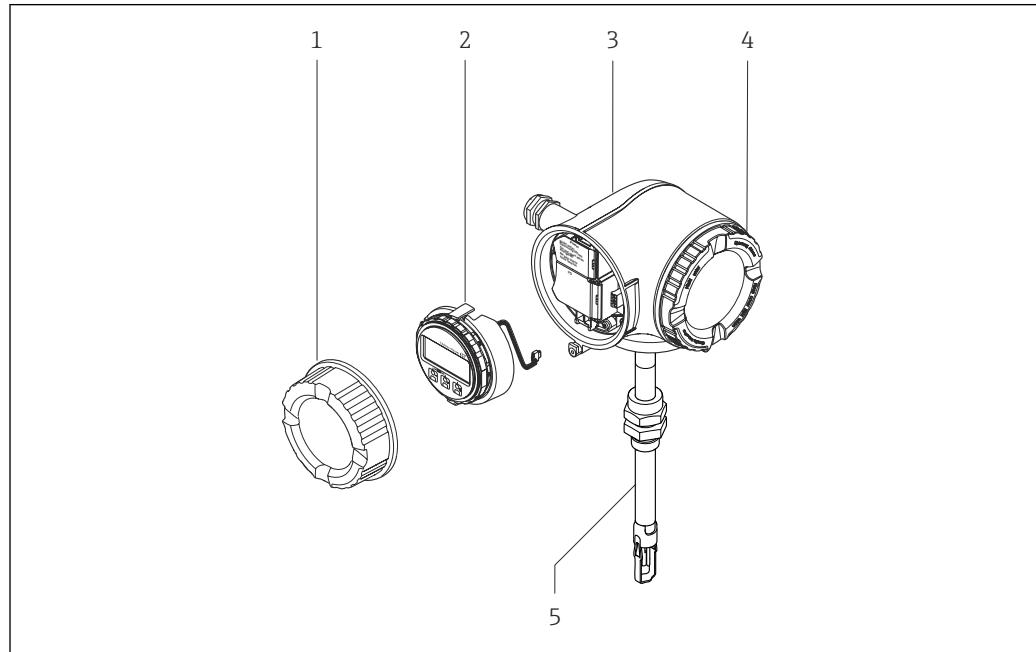

A0042019

- 1 Connection compartment cover
- 2 Display module
- 3 Transmitter housing
- 4 Electronics compartment cover
- 5 Sensor

4 Incoming acceptance and product identification

4.1 Incoming acceptance

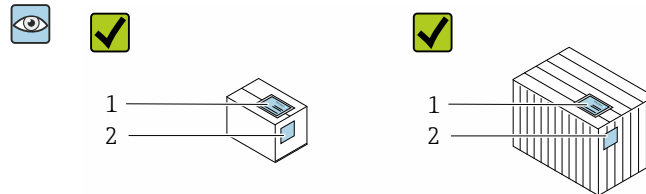

Are the order codes on the delivery note (1) and the product sticker (2) identical?

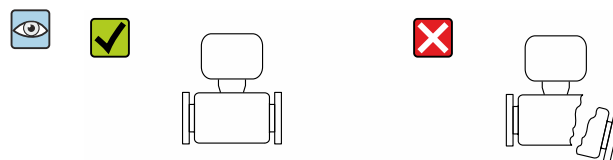
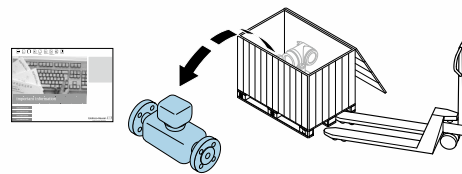

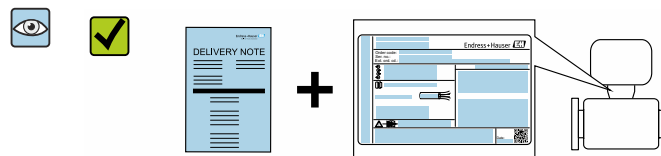

Are the goods undamaged?

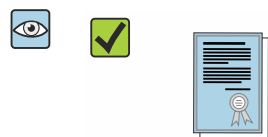

Does the data on the nameplate match the order specifications on the delivery note?



Is the envelope present with accompanying documents?

-  If one of the conditions is not satisfied, contact your Endress+Hauser Sales Center.
- The Technical Documentation is available via the Internet or via the *Endress+Hauser Operations app*: Product identification →  16.

4.2 Product identification

The following options are available for identification of the device:

- Nameplate
- Order code with details of the device features on the delivery note
- Enter the serial numbers from the nameplates in the *Device Viewer* (www.endress.com/deviceviewer): all the information about the device is displayed.
- Enter the serial numbers from the nameplates into the *Endress+Hauser Operations app* or scan the DataMatrix code on the nameplate with the *Endress+Hauser Operations app*: all the information about the device is displayed.

For an overview of the scope of the associated Technical Documentation, refer to the following:

- The "Additional standard documentation on the device" and "Supplementary device-dependent documentation" sections
- The *Device Viewer*: Enter the serial number from the nameplate (www.endress.com/deviceviewer)
- The *Endress+Hauser Operations app*: Enter the serial number from the nameplate or scan the DataMatrix code on the nameplate.

4.2.1 Transmitter nameplate

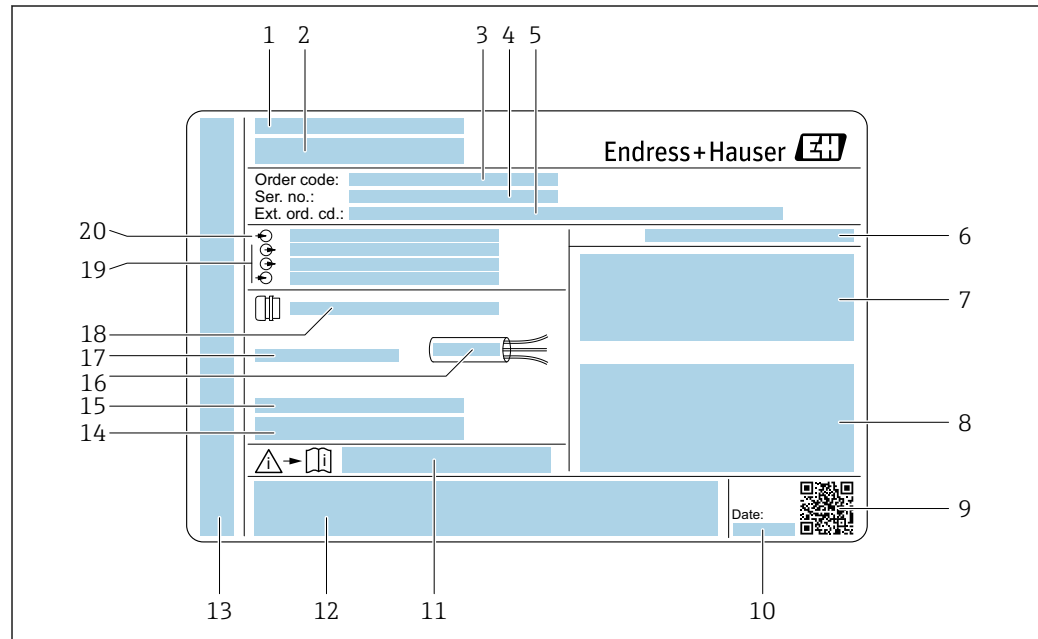

A0029192

1 Example of a transmitter nameplate

- 1 Manufacturer address/certificate holder
- 2 Name of the transmitter
- 3 Order code
- 4 Serial number
- 5 Extended order code
- 6 Degree of protection
- 7 Space for approvals: use in hazardous areas
- 8 Electrical connection data: available inputs and outputs
- 9 2-D matrix code
- 10 Date of manufacture: year-month
- 11 Document number of safety-related supplementary documentation
- 12 Space for approvals and certificates: e.g. CE mark, RCM tick
- 13 Space for degree of protection of connection and electronics compartment when used in hazardous areas
- 14 Firmware version (FW) and device revision (Dev. rev.) from the factory
- 15 Space for additional information in the case of special products
- 16 Permitted temperature range for cable
- 17 Permitted ambient temperature (T_a)
- 18 Information on cable gland
- 19 Available inputs and outputs, supply voltage
- 20 Electrical connection data: supply voltage

4.2.2 Sensor nameplate

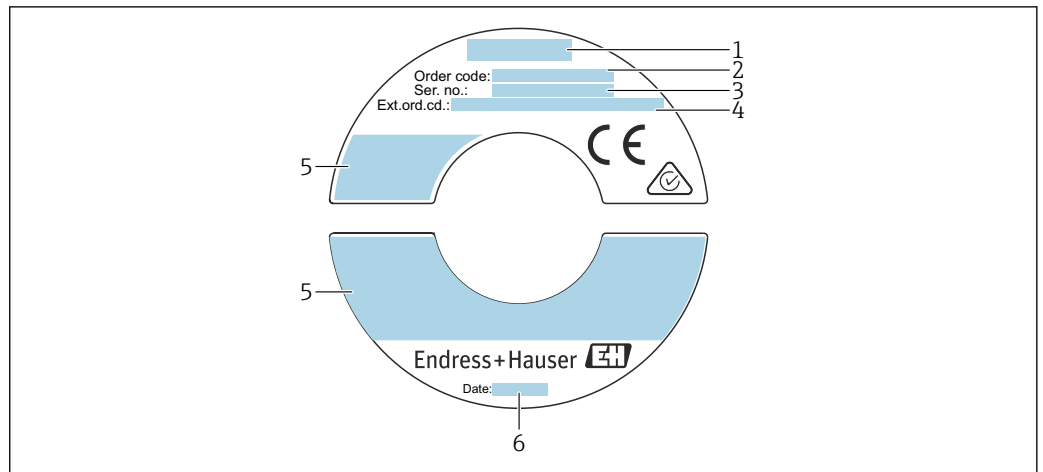

A0041926

2 Example of sensor nameplate

- 1 Name of sensor
- 2 Order code
- 3 Serial number
- 4 Extended order code
- 5 Flow; length of sensor; pressure rating; nominal pressure; system pressure; medium temperature range; permitted ambient temperature range (T_a); explosion protection approval information, Pressure Equipment Directive and degree of protection
- 6 Date of manufacture: year-month

Order code

The measuring device is reordered using the order code.

Extended order code

- The device type (product root) and basic specifications (mandatory features) are always listed.
- Of the optional specifications (optional features), only the safety and approval-related specifications are listed (e.g. LA). If other optional specifications are also ordered, these are indicated collectively using the # placeholder symbol (e.g. #LA#).
- If the ordered optional specifications do not include any safety and approval-related specifications, they are indicated by the + placeholder symbol (e.g. XXXXXX-ABCDE+).

4.2.3 Symbols on the device

| Symbol | Meaning |
|--------|---|
| | WARNING! This symbol alerts you to a dangerous situation. Failure to avoid this situation can result in serious or fatal injury. Please consult the documentation for the measuring device to discover the type of potential danger and measures to avoid it. |
| | Reference to documentation Refers to the corresponding device documentation. |
| | Protective ground connection A terminal that must be connected to the ground prior to establishing any other connections. |

4.3 Storage and transport

4.3.1 Storage conditions

Observe the following notes for storage:

- ▶ Store in the original packaging to ensure protection from shock.
- ▶ Do not remove protective covers or protective caps installed on process connections. They prevent mechanical damage to the sealing surfaces and contamination in the measuring tube.
- ▶ Protect from direct sunlight. Avoid unacceptably high surface temperatures.
- ▶ Select a storage location that excludes the possibility of condensation forming on the measuring device. Fungi and bacteria can damage the liner.
- ▶ Store in a dry and dust-free place.
- ▶ Do not store outdoors.

Storage temperature →  187

4.3.2 Transporting the product

Transport the measuring device to the measuring point in the original packaging.



Do not remove protection caps. They prevent mechanical damage.

4.3.3 Packaging disposal

All packaging materials are environmentally friendly and 100% recyclable:

- Outer packaging of device
 - Stretch wrap made of polymer in accordance with EU Directive 2002/95/EC (RoHS)
- Packaging
 - Wood crate treated in accordance with ISPM 15 standard, confirmed by IPPC logo
 - Cardboard box in accordance with European packaging guideline 94/62/EC, recyclability confirmed by Resy symbol
- Transport material and fastening fixtures
 - Disposable plastic pallet
 - Plastic straps
 - Plastic adhesive strips
- Filler material
 - Paper pads

5 Mounting



5.1 Mounting requirements

- The recommended inlet and outlet specifications must be observed.
- The piping system and the device must be installed according to good engineering practice.
- Ensure the correct alignment and orientation of the sensor.
- Take measures to avoid or prevent condensation (e.g. condensation trap, thermal insulation etc.).
- Observe the maximum permissible ambient temperatures and medium temperature range.
- Install the measuring device in a shady location or use a weather protection cover.
- For mechanical reasons and to protect the pipe, support is recommended for heavy sensors (e.g. with a hot-tap retractable assembly).

5.1.1 Installation position

Orientation

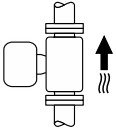
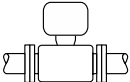
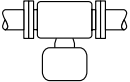
The direction of flow must match the direction of the arrow on the sensor. In the case of the bidirectional sensor, the arrow points in the positive direction. When performing bidirectional measurement, the sensing element must be installed with an accuracy of 3°.

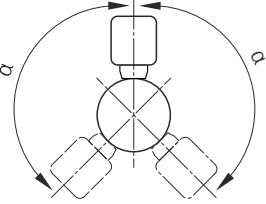
| Orientation | | Recommendation |
|--|--|---|
| Vertical orientation |  <p style="text-align: right; font-size: small;">A0015591</p> | <input checked="" type="checkbox"/> ¹⁾ |
| Horizontal orientation, transmitter head up |  <p style="text-align: right; font-size: small;">A0015589</p> | <input checked="" type="checkbox"/> <input checked="" type="checkbox"/> |
| Horizontal orientation, transmitter head down |  <p style="text-align: right; font-size: small;">A0015590</p> | <input checked="" type="checkbox"/> ²⁾ |
| Horizontal orientation, transmitter head at side |  <p style="text-align: right; font-size: small;">A0015592</p> | <input checked="" type="checkbox"/> |
| Inclined orientation, transmitter head down |  <p style="text-align: right; font-size: small;">A0015773</p> | <input checked="" type="checkbox"/> ²⁾ |

- 1) In the case of saturated or impure gases, vertical orientation is preferred in order to minimize condensation or contamination. For bidirectional sensors, select horizontal orientation.
- 2) Select inclined orientation ($\alpha = \text{approx. } 135^\circ$) for very wet or water-saturated gas (e.g. digester gas, undried compressed air), or if deposits or condensate are constantly present.

Pipes

The measuring device must be professionally installed, and the following points must be observed:

- Weld pipes professionally.
- Use seals of the correct size.
- Align flanges and seals correctly.
- Remove protection cap from sensing element.
- Following installation, the pipe must be free from dirt and particles in order to avoid damage to the sensors.
- For further information → ISO standard 14511.

Sensor selection and arrangement

The minimum length of the sensor can be determined using the Endress+Hauser Applicator program (version 10.00 or higher) or with the calculation formula below.

The minimum length of the sensor is determined by the necessary insertion depth. The calculated necessary insertion depth must be within the adjusting range of the selected insertion version.

Insertion depth

The minimum length of the insertion version can be determined using the Endress+Hauser Applicator program or with the calculation formula below. The calculated necessary insertion depth must be within the adjusting range of the selected insertion version.

NOTICE

Metal ferrules undergo plastic deformation during the initial installation.

As a result the insertion depth is fixed after initial installation and the ferrules can no longer be replaced.

- ▶ Pay attention to information on preconditions and on determining the insertion depth.
- ▶ Check the insertion depth closely before tightening the ferrules.

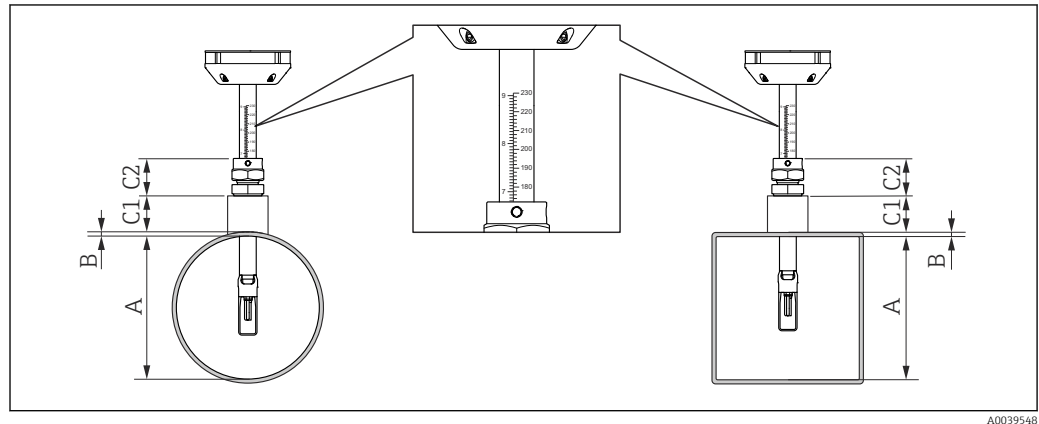

3 Determine the dimensions A, B, C1 and C2

A In the case of a circular pipe: the pipe internal diameter (DN); in the case of a duct: the inner dimension

B Thickness of pipe wall or of duct wall

C1 Mounting kit

C2 Sensor's compression fitting

Calculating the insertion depth



$$\text{Insertion depth} = (0.3 \cdot A) + B + (C1 + C2)$$



The insertion depth must be at least 100mm.

*Determining dimensions C1 and C2**If only Endress+Hauser mounting bosses are used*

| | |
|-----------------------------|-----------------------------|
| Mounting boss 1" NPT | C1 + C2 = 112 mm (4.409 in) |
| Mounting boss G1" | C1 + C2 = 106 mm (4.173 in) |
| Mounting boss ¾" NPT | C1 + C2 = 108 mm (4.252 in) |
| Mounting boss G¾" | C1 + C2 = 105 mm (4.134 in) |

 If a cold/hot tap is used, use dimension "L" →  191 instead of "C1".

 Use Applicator to determine dimensions C1 and C2 if using other E+H mounting kits (e.g. cold/hot taps).

If not exclusively using Endress+Hauser mounting bosses

| | |
|--|--------------------------------|
| C1 | Length of pipe connection used |
| C2 (compression fitting with 1" NPT thread) | 52 mm (2.047 in) |
| C2 (compression fitting with G1" thread) | 46 mm (1.811 in) |
| C2 (compression fitting with ¾" NPT thread) | 48 mm (1.889 in) |
| C2 (compression fitting with G¾" thread) | 45 mm (1.772 in) |

Selecting the length of the insertion version

Select the length of the insertion version using the calculated insertion depth and the following table. The insertion depth must be within the adjusting range of the insertion version.

| Length of insertion tube | | Adjusting range (insertion depth) | |
|--------------------------|------|-----------------------------------|-------------|
| [mm] | [in] | [mm] | [in] |
| 235 | 9 | 100 to 235 | 3.9 to 9.3 |
| 335 | 13 | 100 to 335 | 3.9 to 13.2 |
| 435 | 17 | 100 to 435 | 3.9 to 17.1 |
| 608 | 24 | 100 to 608 | 3.9 to 23.9 |

Inlet and outlet runs

A fully developed flow profile is a requirement for optimal thermal flow measurement.

To achieve the best possible measuring performance, observe the following inlet and outlet runs at the very minimum.

- In the case of bidirectional sensors, also observe the recommended inlet run in the opposite direction.
- If several flow disturbances are present, use flow conditioners.
- Use flow conditioners if it is not possible to observe the required inlet runs.
- In the case of control valves, the amount of disturbance depends on the valve type and opening degree. The recommended inlet run for control valves is $50 \times \text{DN}$.
- In the case of very light gases (helium, hydrogen), the recommended inlet run must be doubled.

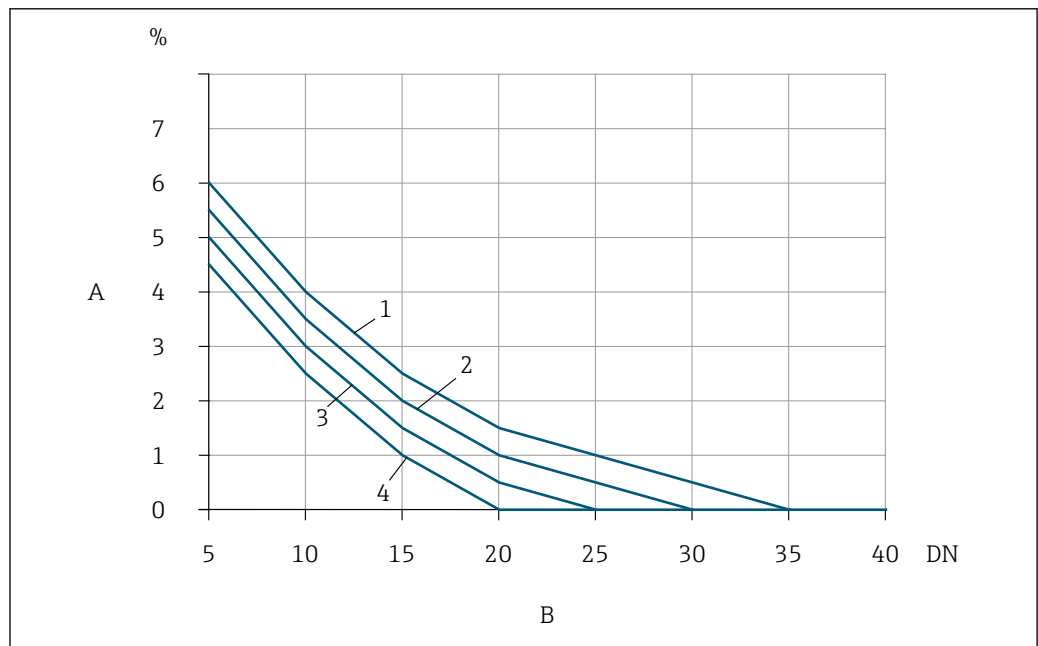
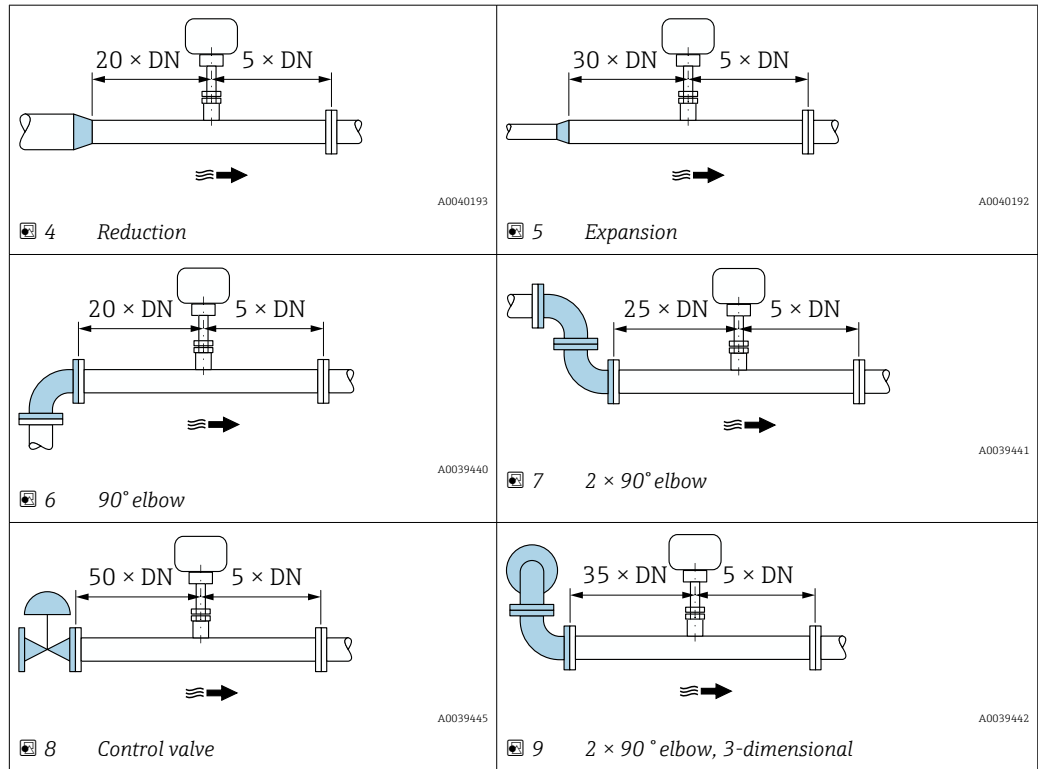

10 The additional measured error to be expected without flow conditioners depending on the disturbance type and inlet run

- A Additional measured error (%)
- B Inlet run (DN)
- 1 2 × 90° elbow, 3-dimensional
- 2 Expansion
- 3 2 × 90° elbow
- 4 Reduction or 90° elbow

Flow conditioner

Use flow conditioners if it is not possible to observe the required inlet runs. Flow conditioners improve the flow profile and therefore reduce the necessary inlet runs.

Mount the flow conditioner in flow direction in front of the measuring device.

Available in the following flange standards:

- ASME B16.5 Cl. 150/Cl. 300
- EN 1092-1 PN10/PN16/PN25/PN40
- JIS B2220 10K/20K

Available in the following line sizes:

- DN 80 (3")
- DN 100 (4")
- DN 150 (6")
- DN 200 (8")
- DN 250 (10")
- DN 300 (12")

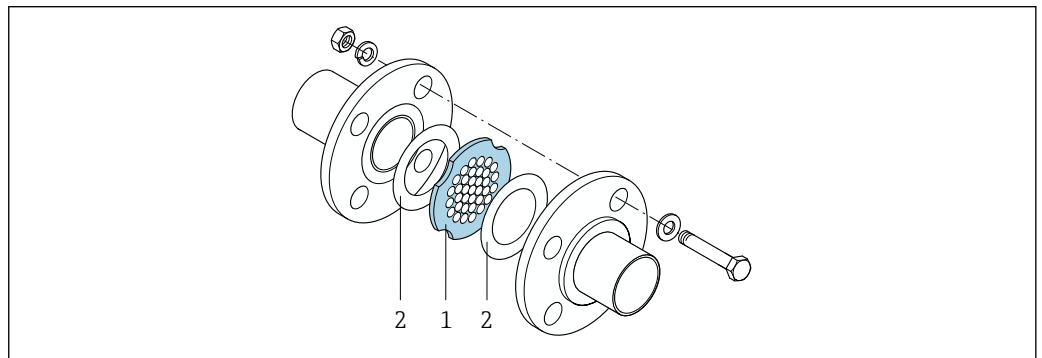

A0039538

- 1 Flow conditioner
2 Seal

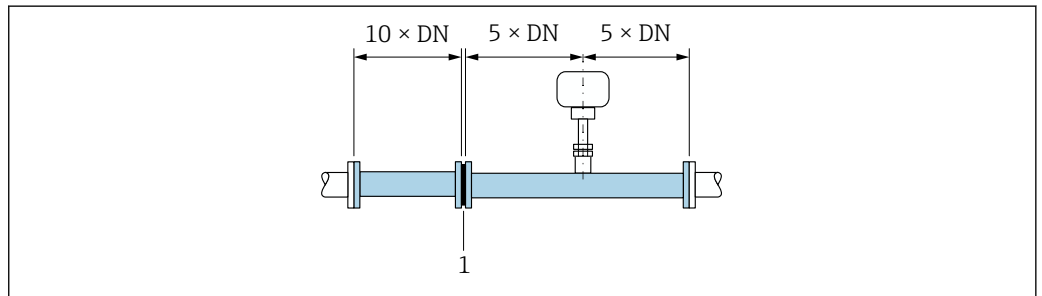

A0039424

11 Recommended inlet and outlet runs when using a flow conditioner

- 1 Flow conditioner

i In the case of bidirectional sensors, also observe the inlet run in the opposite direction.

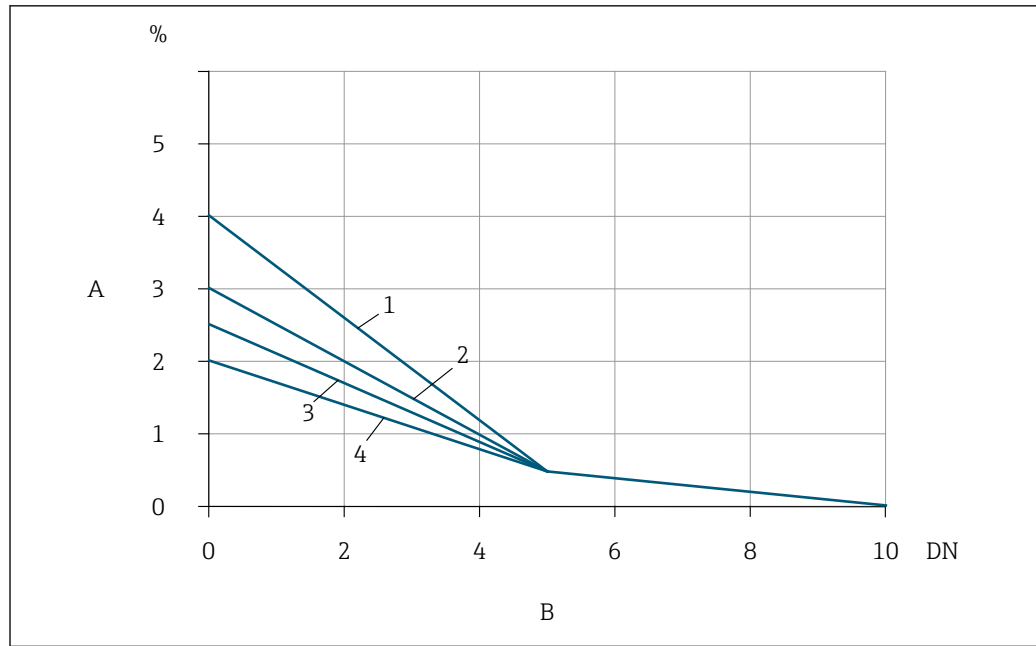

A0039508

12 The additional measured error to be expected with flow conditioners depending on the disturbance type and inlet run

- A Additional measured error (%)
 B Inlet runs upstream of the flow conditioner (DN)
 1 2 × 90° elbow, 3-dimensional
 2 Expansion
 3 2 × 90° elbow
 4 Reduction or 90° elbow

The pressure loss for flow conditioners is calculated as follows: $\Delta p \text{ [mbar]} = 0.0085 \cdot \rho \text{ [kg/m}^3\text{]} \cdot v^2 \text{ [m/s]}$

Example of air

$p = 10 \text{ bar abs.}$

$t = 25 \text{ }^\circ\text{C} \rightarrow \rho = 11.71 \text{ kg/m}^3$

$v = 10 \text{ m/s}$

$\Delta p = 0.0085 \cdot 11.71 \cdot 10^2 = 9.95 \text{ mbar}$

ρ : density of the process medium

v : average flow velocity

abs. = absolute

Outlet runs with pressure measuring points

Install the pressure measuring point downstream of the measuring system. This prevents the pressure transmitter from potentially affecting the flow in the measuring point.

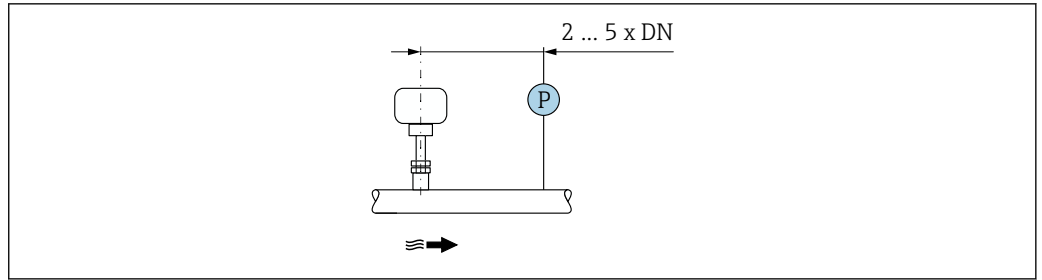

13 Installation of a pressure measuring point (P = pressure transmitter)

Installation conditions for nipples

i Suitable support brackets must be used if installing in rectangular air ducts (or pipes with thin walls).

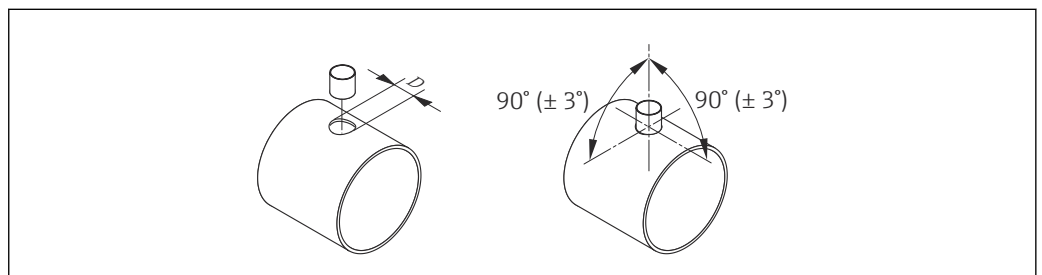

D $\varnothing 31.0 \pm 0.5 \text{ mm}$ (1.22 ± 0.019 in)

5.1.2 Environment and process requirements

Ambient temperature range

| | |
|----------------------------------|---|
| Measuring device | <ul style="list-style-type: none"> ■ -40 to +60 °C (-40 to +140 °F) ■ Order code for "Test, certificate", option JP: -50 to +60 °C (-58 to +140 °F) |
| Readability of the local display | <p>-20 to +60 °C (-4 to +140 °F)</p> <p>The readability of the display may be impaired at temperatures outside the temperature range.</p> |

NOTICE

Danger of overheating

- ▶ Ensure that the temperature at the lower end of the transmitter housing does not exceed 80 °C (176 °F).
- ▶ Ensure that sufficient convection takes place at the transmitter neck.
- ▶ When using in potentially explosive atmospheres, observe the information in the device-specific Ex documentation. For detailed information on the temperature tables, see the separate document entitled "Safety Instructions" (XA) for the device.
- ▶ Ensure that a sufficiently large area of the transmitter neck remains exposed. The uncovered part serves as a radiator and protects the electronics from overheating and excessive cooling.
- ▶ If operating outdoors:
Avoid direct sunlight, particularly in warm climatic regions.

i You can order a weather protection cover from Endress+Hauser → 168.

System pressure

Pressure-reducing valves and some compressor systems can generate significant process pressure variations that can distort the flow profile. This can produce an additional measured error. Suitable measures must be taken to reduce these pressure pulses, such as:

- The use of expansion tanks
- The use of inlet diffusers
- Positioning the measuring device further downstream

To avoid pulsating flow and contamination from oil/dirt in compressed air applications, it is recommended to install the measuring device downstream of filter, drying and storage devices. Do not install the measuring device directly after the compressor.

Thermal insulation

In the case of some fluids, it is important to keep the heat radiated from the sensor to the transmitter to a low level. A wide range of materials can be used for the required insulation.

If the gas is very wet or saturated with water (e.g. digester gas), the pipe and the sensor housing should be insulated, and heated where necessary, to prevent water droplets condensing on the sensing element.

NOTICE

Electronics overheating on account of thermal insulation!

- ▶ Recommended orientation: horizontal orientation, transmitter housing pointing downwards.
- ▶ Do not insulate the transmitter housing .
- ▶ Maximum permissible temperature at the lower end of the transmitter housing: 80 °C (176 °F)
- ▶ Thermal insulation with not isolated extended neck: We recommend that you do not insulate the extended neck in order to ensure optimum dissipation of heat.

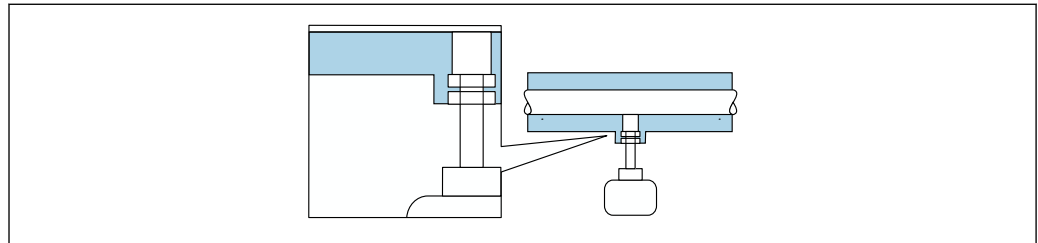

A0039420

14 Thermal insulation with not isolated extended neck

Heating

NOTICE

Electronics can overheat due to elevated ambient temperature!

- ▶ Observe maximum permitted ambient temperature for the transmitter.
- ▶ Depending on the medium temperature, take the device orientation requirements into account.

NOTICE

Electronics overheating on account of thermal insulation!

- ▶ Recommended orientation: horizontal orientation, transmitter housing pointing downwards.
- ▶ Do not insulate the transmitter housing .
- ▶ Maximum permissible temperature at the lower end of the transmitter housing: 80 °C (176 °F)
- ▶ Thermal insulation with extended neck free: We recommend that you do not insulate the extended neck in order to ensure optimum dissipation of heat.

NOTICE**Danger of overheating when heating**

- ▶ Ensure that the temperature at the lower end of the transmitter housing does not exceed 80 °C (176 °F).
- ▶ Ensure that sufficient convection takes place at the transmitter neck.
- ▶ When using in potentially explosive atmospheres, observe the information in the device-specific Ex documentation. For detailed information on the temperature tables, see the separate document entitled "Safety Instructions" (XA) for the device.
- ▶ Ensure that a sufficiently large area of the transmitter neck remains exposed. The uncovered part serves as a radiator and protects the electronics from overheating and excessive cooling.

Heating options

If a fluid requires that no heat loss should occur at the sensor, users can avail of the following heating options:

- Electrical heating, e.g. with electric band heaters
- Via pipes carrying hot water or steam

Vibrations**NOTICE****Strong vibrations can damage the measuring device.**

Can result in damage to the measuring device or the fastening units.

- ▶ Pay attention to information on the vibration and shock resistance →  187

5.1.3 Special mounting instructions**Zero adjust**

All measuring devices are calibrated in accordance with state-of-the-art technology. Calibration takes place under reference conditions. Therefore, a zero adjustment in the field is generally not required.

Experience shows that zero adjustment is advisable only in special cases:

- If strict measuring accuracy requirements apply.
- Under extreme process or operating conditions, e.g., very high process temperatures or light gases (helium, hydrogen).

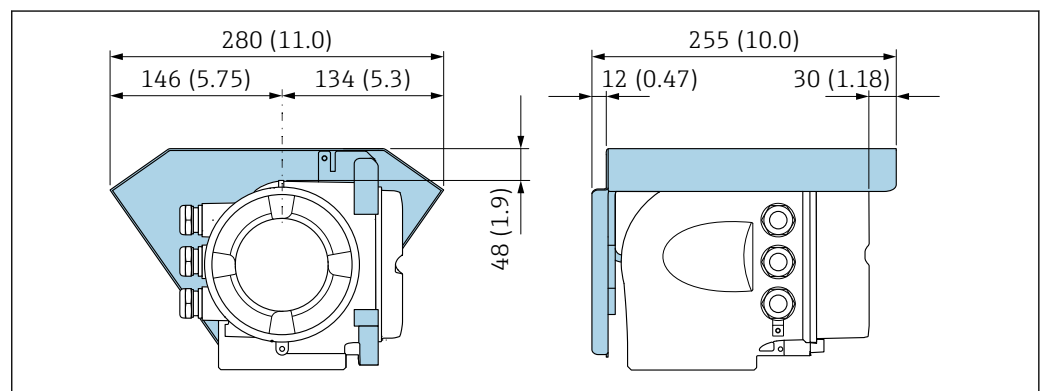
Weather protection cover

 15 Engineering unit mm (in)

A0029553

5.2 Mounting the measuring device

5.2.1 Required tool

For sensor

Sensor's compression fitting: appropriate mounting tool.

5.2.2 Preparing the measuring device

1. Remove all remaining transport packaging.
2. Remove any protective covers or protective caps present from the sensor.
3. Remove stick-on label on the electronics compartment cover.

5.2.3 Mounting the measuring device

⚠ WARNING

Danger due to improper process sealing!

- ▶ Ensure that the seals are clean and undamaged.
- ▶ Ensure that the correct sealing material is used (e.g. Teflon tape for NPT compression fitting).
- ▶ Secure the seals correctly.

Install the measuring device or turn the transmitter housing so that the cable entries do not point upwards.

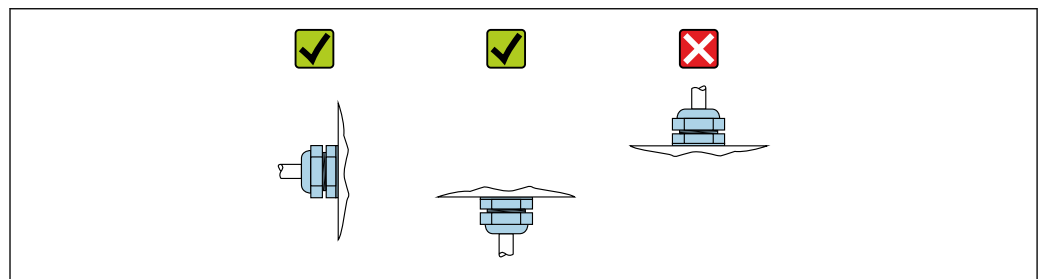

A0029263

1. Weld in the mounting boss in accordance with the requirements.
2. Loosen the union nut (1) and push down the compression fitting (2).

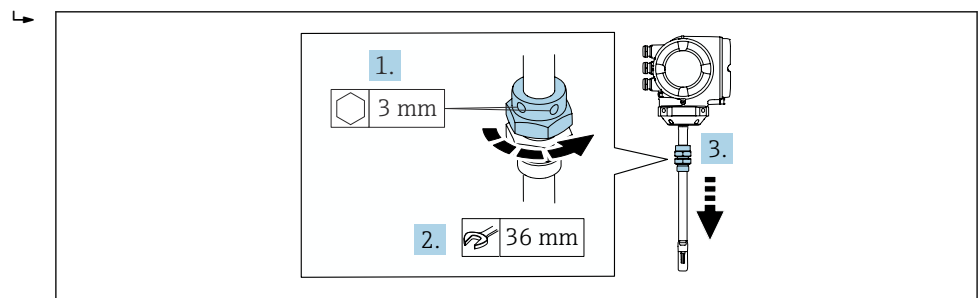

A0041022

3. NOTICE**Damage to the sensing element!**

- ▶ Make sure the sensing elements do not hit against anything.

Using a wrench (27 mm / 35 mm / 41 mm), tighten the bottom nut of the compression fitting to the end stop.

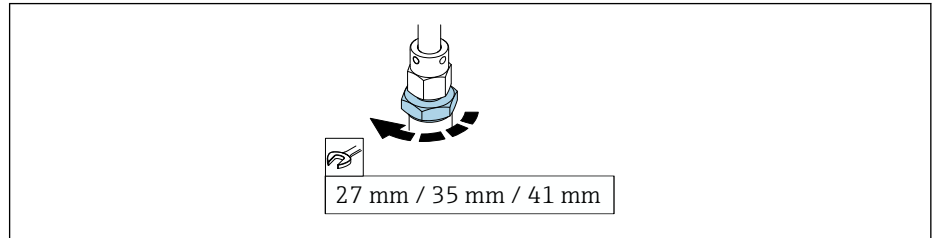

A0036810

4. Now read off the previously calculated insertion depth from the scale and insert the sensor until this value is at the same height as the upper end of the compression fitting.

5. Tighten the union nut by hand. It should still be possible to move the sensor slightly.

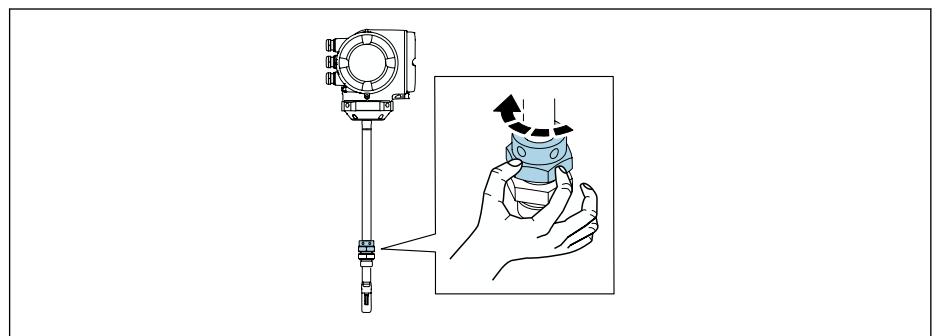

A0041024

6. Align the sensor with the flow direction.

- ▶ Pay attention to the direction of the arrow on the neck section of the sensor for the flow direction.

The maximum permitted deviation from the flow direction is 3°.

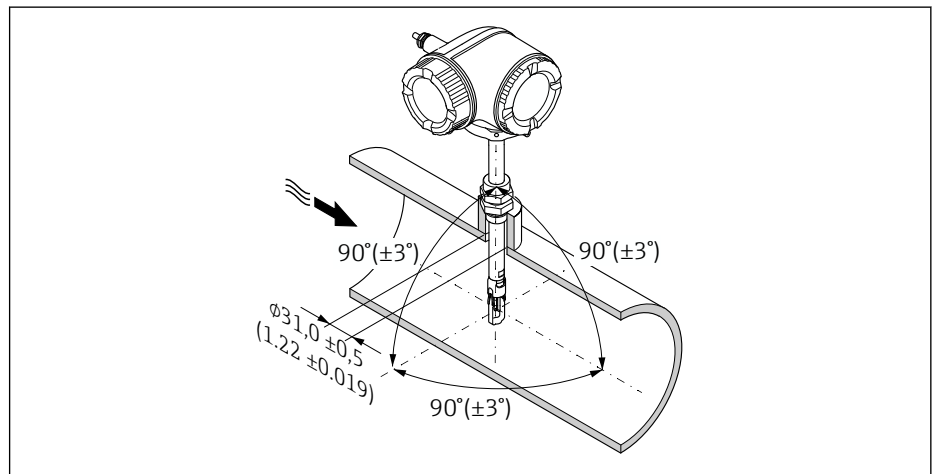

A0039511

16 Engineering unit: mm (in)

7. Depending on the process connection:

Tighten union nut with x turns:

- ▶ For PEEK ferrules continue with Step 8.
- ▶ For metal ferrules continue with Step 9.

8. **For PEEK ferrules:**
Mounting for the first time: tighten union nut with $1\frac{1}{4}$ turns. Repeat mounting: tighten union nut with 1 turn.
↳ **Tip** If strong vibrations can be expected, tighten the union nut with $1\frac{1}{2}$ turns when mounting for the first time.
9. **For metal ferrules:**
Mounting for the first time: tighten union nut with $1\frac{1}{4}$ turns. Repeat mounting: tighten union nut with $\frac{1}{4}$ turn.
10. Tighten both fixing screws again with a 3 mm ($\frac{1}{8}$ in) Allen screw with 4 Nm (2.95 lbf ft).
↳ It is now no longer possible to move the sensor.
11. Check the measuring point for leaks (max. process pressure).

5.2.4 Turning the transmitter housing

To provide easier access to the connection compartment or display module, the transmitter housing can be turned.

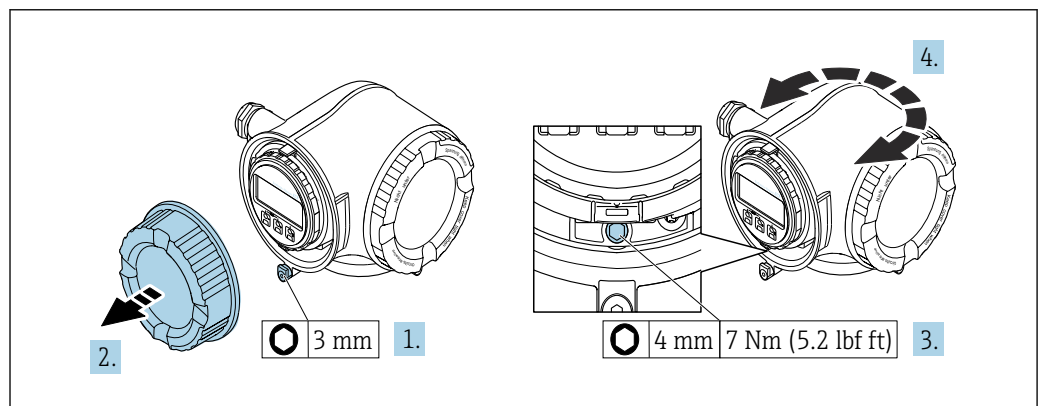

17 Non-Ex housing

1. Depending on the device version: Loosen the securing clamp of the connection compartment cover.
2. Unscrew the connection compartment cover.
3. Loosen the securing screw.
4. Turn the housing to the desired position.
5. Tighten the securing screw.
6. Screw on the connection compartment cover.
7. Depending on the device version: Attach the securing clamp of the connection compartment cover.

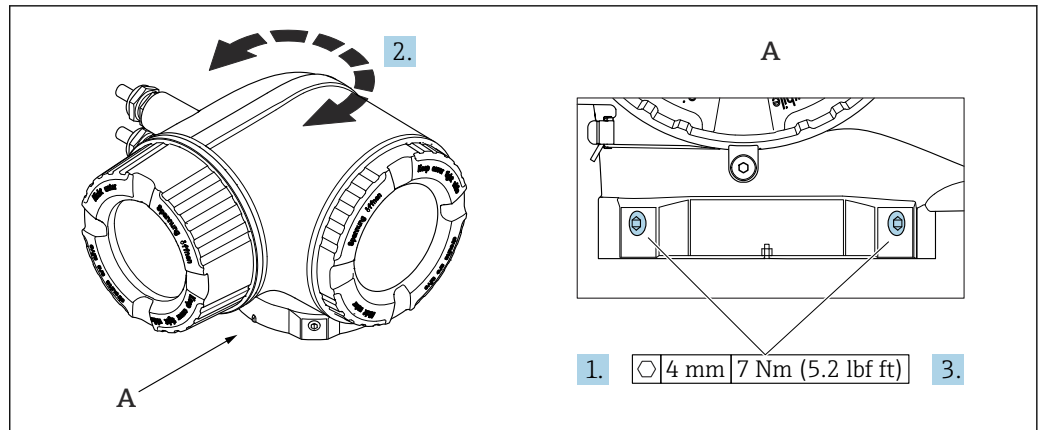

18 Ex housing

1. Loosen the fixing screws.
2. Turn the housing to the desired position.
3. Tighten the securing screws.

5.2.5 Turning the display module

The display module can be turned to optimize display readability and operability.

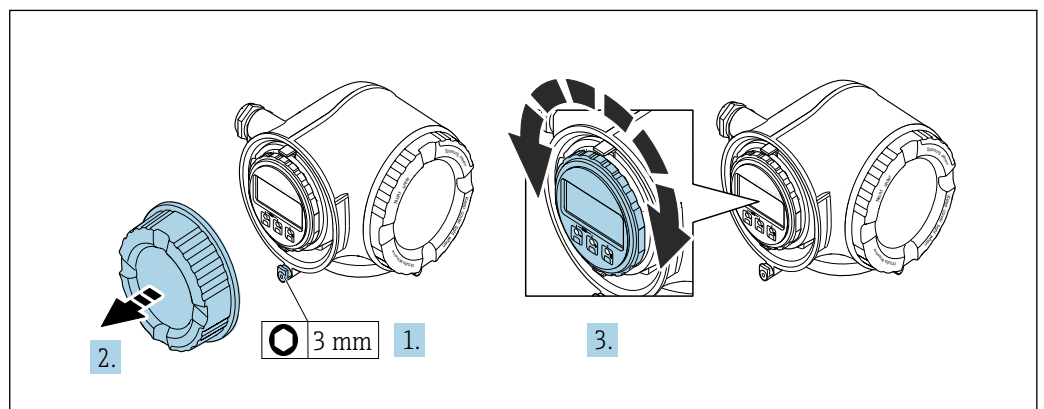

1. Depending on the device version: Loosen the securing clamp of the connection compartment cover.
2. Unscrew the connection compartment cover.
3. Turn the display module to the desired position: max. $8 \times 45^\circ$ in each direction.
4. Screw on the connection compartment cover.
5. Depending on the device version: Attach the securing clamp of the connection compartment cover.

5.3 Post-installation check

| | |
|--|--------------------------|
| Is the device undamaged (visual inspection)? | <input type="checkbox"/> |
| Does the measuring device conform to the measuring point specifications? For example: <ul style="list-style-type: none"> ▪ Process temperature → 189 ▪ Process pressure (refer to the "Pressure-temperature ratings" section of the "Technical Information" document) ▪ Ambient temperature → 25 ▪ Measuring range → 173 | <input type="checkbox"/> |
| Has the correct orientation been selected for the sensor → 19? <ul style="list-style-type: none"> ▪ According to sensor type ▪ According to medium properties ▪ According to medium temperature ▪ According to process pressure | <input type="checkbox"/> |
| Does the arrow on the sensor match the actual direction of flow of the medium through the piping ? | <input type="checkbox"/> |
| Have sufficient inlet and outlet runs been provided upstream and downstream of the measuring point → 21? | <input type="checkbox"/> |
| Correct sensor insertion depth? | <input type="checkbox"/> |
| Is the device adequately protected from precipitation and direct sunlight? | <input type="checkbox"/> |
| Is the device protected against overheating? | <input type="checkbox"/> |
| Is the device protected against excessive vibrations? | <input type="checkbox"/> |
| Gas property checked (e.g. purity, dryness, cleanness)? | <input type="checkbox"/> |
| Are the measuring point identification and labeling correct (visual inspection)? | <input type="checkbox"/> |
| Are the securing screw and securing clamp tightened securely? | <input type="checkbox"/> |

6 Electrical connection

⚠ WARNING

Live parts! Incorrect work performed on the electrical connections can result in an electric shock.

- ▶ Set up a disconnecting device (switch or power-circuit breaker) to easily disconnect the device from the supply voltage.
- ▶ In addition to the device fuse, include an overcurrent protection unit with max. 10 A in the plant installation.

6.1 Electrical safety

In accordance with applicable national regulations.

6.2 Connecting requirements

6.2.1 Required tools

- For cable entries: Use corresponding tools
- For securing clamp: Allen key 3 mm
- Wire stripper
- When using stranded cables: Crimper for wire end ferrule
- For removing cables from terminal: Flat blade screwdriver ≤ 3 mm (0.12 in)

6.2.2 Requirements for connecting cable

The connecting cables provided by the customer must fulfill the following requirements.

Protective grounding cable for the outer ground terminal

Conductor cross-section < 2.1 mm² (14 AWG)

The use of a cable lug enables the connection of larger cross-sections.

The grounding impedance must be less than 2 Ω .

Permitted temperature range

- The installation guidelines that apply in the country of installation must be observed.
- The cables must be suitable for the minimum and maximum temperatures to be expected.

Power supply cable (incl. conductor for the inner ground terminal)

Standard installation cable is sufficient.

Signal cable

Current output 4 to 20 mA HART

A shielded cable is recommended. Observe grounding concept of the plant.

Current output 0/4 to 20 mA

Standard installation cable is sufficient

Pulse /frequency /switch output

Standard installation cable is sufficient

Relay output

Standard installation cable is sufficient.

Current input 0/4 to 20 mA

Standard installation cable is sufficient

Status input

Standard installation cable is sufficient

Cable diameter

- Cable glands supplied:
M20 × 1.5 with cable \varnothing 6 to 12 mm (0.24 to 0.47 in)
- Spring-loaded terminals: Suitable for strands and strands with ferrules.
Conductor cross-section 0.2 to 2.5 mm² (24 to 12 AWG).

Requirements for connecting cable – remote display and operating module DKX001*Optionally available connecting cable*

A cable is supplied depending on the order option

- Order code for measuring device: order code **030** for "Display; operation", option **O**
or
- Order code for measuring device: order code **030** for "Display; operation", option **M**
and
- Order code for DKX001: order code **040** for "Cable", option **A, B, D, E**

| | |
|---------------------------------|--|
| Standard cable | 2 × 2 × 0.34 mm ² (22 AWG) PVC cable with common shield (2 pairs, pair-stranded) |
| Flame resistance | According to DIN EN 60332-1-2 |
| Oil resistance | According to DIN EN 60811-2-1 |
| Shield | Tin-plated copper braid, optical cover ≥ 85 % |
| Capacitance: core/shield | ≤ 200 pF/m |
| L/R | ≤ 24 μH/Ω |
| Available cable length | 5 m (15 ft)/10 m (35 ft)/20 m (65 ft)/30 m (100 ft) |
| Operating temperature | When mounted in a fixed position: -50 to +105 °C (-58 to +221 °F); when cable can move freely: -25 to +105 °C (-13 to +221 °F) |

Standard cable - customer-specific cable

With the following order option, no cable is supplied with the device and must be provided by the customer:

Order code for DKX001: Order code **040** for "Cable", option **1** "None, provided by customer, max 300 m"

A standard cable with the following minimum requirements can be used as the connecting cable, even in the hazardous area (Zone 2, Class I, Division 2 and Zone 1, Class I, Division 1):

| | |
|-------------------------------|---|
| Standard cable | 4 wires (2 pairs); pair-stranded with common shield, minimum wire cross-section 0.34 mm ² (22 AWG) |
| Shield | Tin-plated copper braid, optical cover ≥ 85 % |
| Cable impedance (pair) | Minimum 80 Ω |
| Cable length | Maximum 300 m (1000 ft), maximum loop impedance 20 Ω |

| | |
|---------------------------------|--|
| Capacitance: core/shield | Maximum 1 000 nF for Zone 1, Class I, Division 1 |
| L/R | Maximum 24 μ H/ Ω for Zone 1, Class I, Division 1 |

6.2.3 Terminal assignment

Transmitter: supply voltage, input/outputs

The terminal assignment of the inputs and outputs depends on the individual order version of the device. The device-specific terminal assignment is documented on an adhesive label in the terminal cover.

| Supply voltage | | Input/output 1 | | Input/output 2 | | Input/output 3 | |
|--|-------|----------------|--------|----------------|--------|----------------|--------|
| 1 (+) | 2 (-) | 26 (+) | 27 (-) | 24 (+) | 25 (-) | 22 (+) | 23 (-) |
| Device-specific terminal assignment: adhesive label in terminal cover. | | | | | | | |

i Terminal assignment of the remote display and operating module →  39.

6.2.4 Preparing the measuring device

NOTICE

Insufficient sealing of the housing!

Operational reliability of the measuring device could be compromised.

► Use suitable cable glands corresponding to the degree of protection.

1. Remove dummy plug if present.
2. If the measuring device is supplied without cable glands:
Provide suitable cable gland for corresponding connecting cable.
3. If the measuring device is supplied with cable glands:
Observe requirements for connecting cables →  33.

6.3 Connecting the measuring device

NOTICE

An incorrect connection compromises electrical safety!

- Have electrical connection work carried out by appropriately trained specialists only.
- Observe applicable federal/national installation codes and regulations.
- Comply with local workplace safety regulations.
- Always connect the protective ground cable  before connecting additional cables.
- When using in potentially explosive atmospheres, observe the information in the device-specific Ex documentation.

6.3.1 Connecting the transmitter

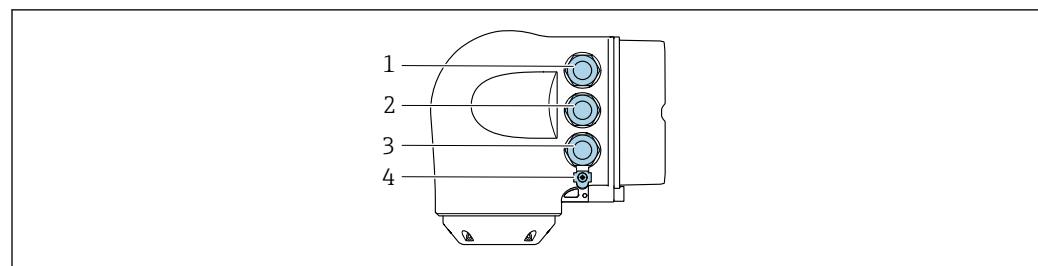

A0026781

- 1 Terminal connection for supply voltage
- 2 Terminal connection for signal transmission, input/output
- 3 Terminal connection for signal transmission, input/output or terminal connection for network connection via service interface (CDI-RJ45); optional: connection for external WLAN antenna or remote display and operating module DKX001
- 4 Protective earth (PE)

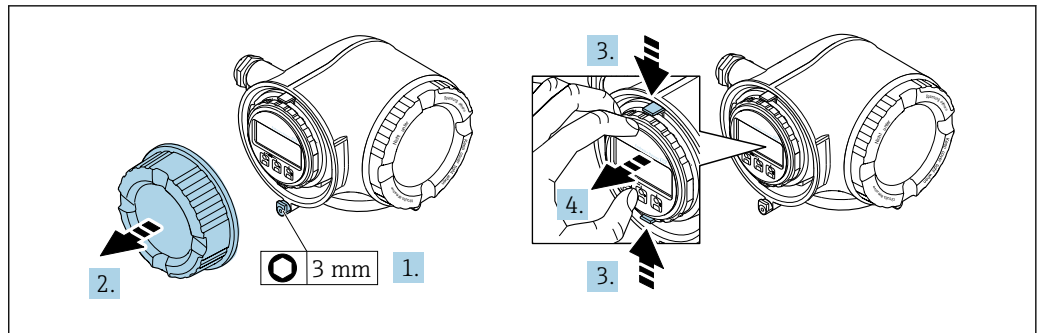

A0029813

1. Loosen the securing clamp of the connection compartment cover.
2. Unscrew the connection compartment cover.
3. Squeeze the tabs of the display module holder together.
4. Remove the display module holder.

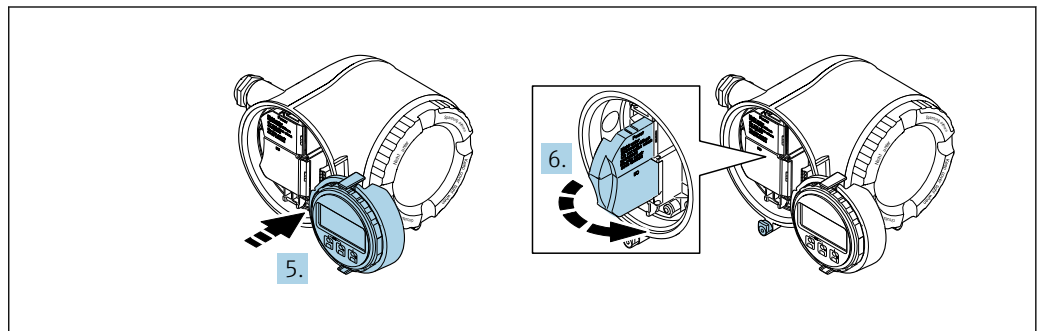

A0029814

5. Attach the holder to the edge of the electronics compartment.
6. Open the terminal cover.

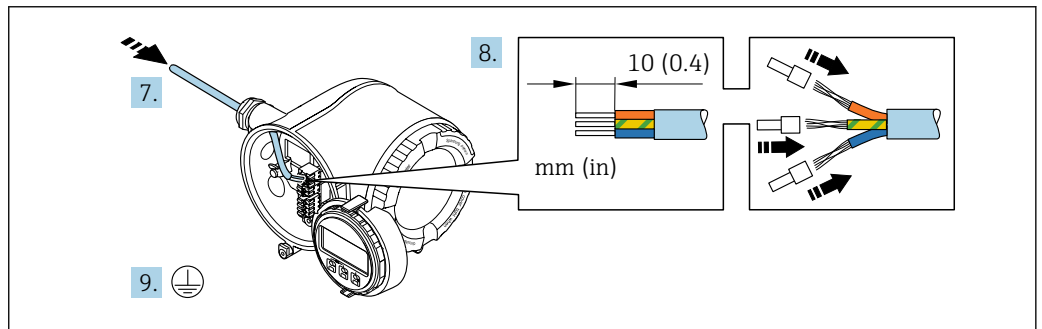

A0029815

7. Push the cable through the cable entry. To ensure tight sealing, do not remove the sealing ring from the cable entry.
8. Strip the cable and cable ends. In the case of stranded cables, also fit ferrules.
9. Connect the protective ground.

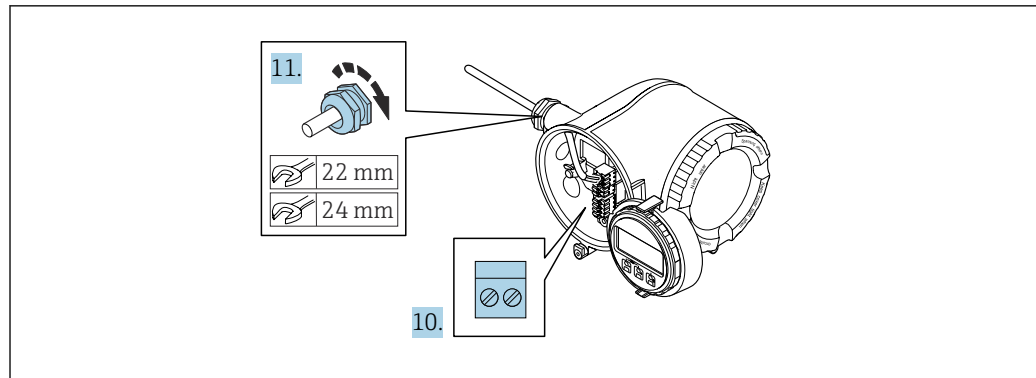

A0029816

10. Connect the cable according to the terminal assignment.
 - ↳ **Signal cable terminal assignment:** The device-specific terminal assignment is documented on an adhesive label in the terminal cover.
 - Supply voltage terminal assignment:** Adhesive label in the terminal cover or → 36.
11. Firmly tighten the cable glands.
 - ↳ This concludes the cable connection process.
12. Close the terminal cover.
13. Fit the display module holder in the electronics compartment.
14. Screw on the connection compartment cover.
15. Secure the securing clamp of the connection compartment cover.

Removing a cable

To remove a cable from the terminal:

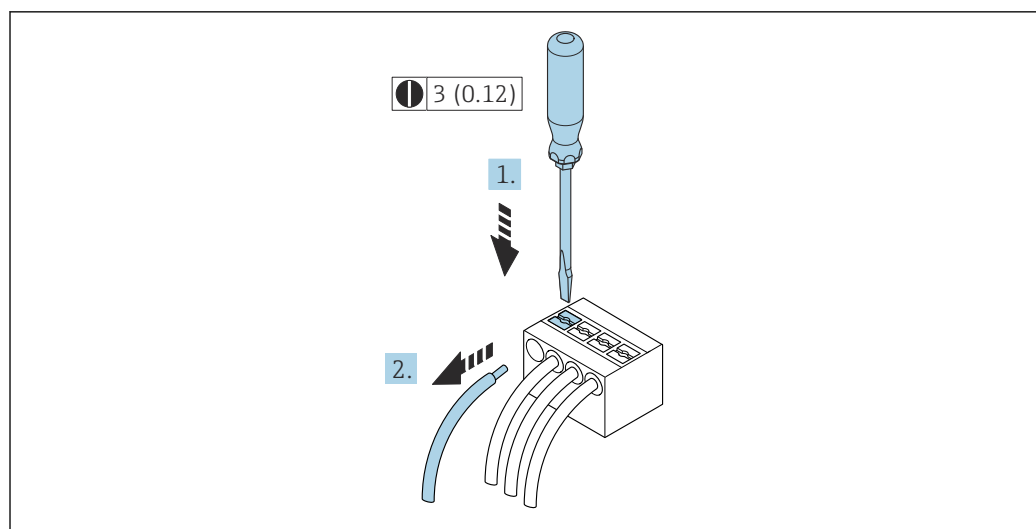

A0029598

19 Engineering unit mm (in)

1. Use a flat-blade screwdriver to press down on the slot between the two terminal holes.
2. Remove the cable end from the terminal.

6.3.2 Connecting the remote display and operating module DKX001

i The remote display and operating module DKX001 is available as an optional extra → 168.

- The measuring device is always supplied with a dummy cover when the remote display and operating module DKX001 is ordered directly with the measuring device. Display or operation at the transmitter is not possible in this case.
- If ordered subsequently, the remote display and operating module DKX001 may not be connected at the same time as the existing measuring device display module. Only one display or operation unit may be connected to the transmitter at any one time.

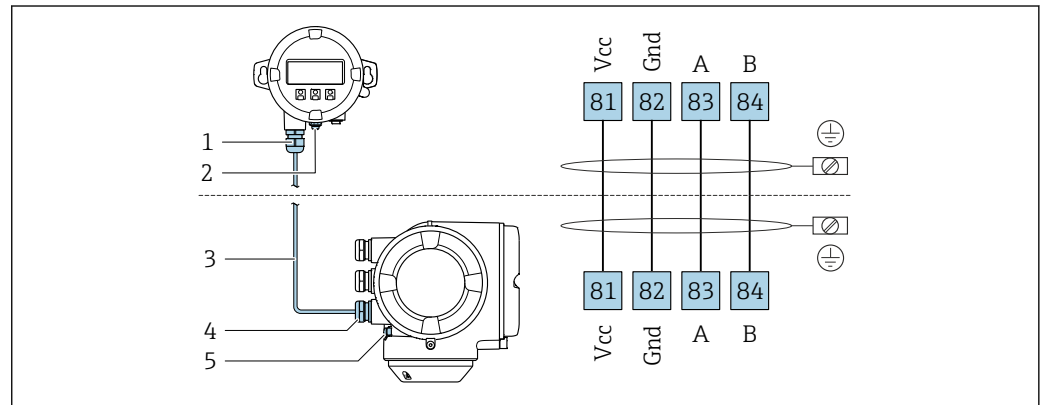

A0027518

- 1 Remote display and operating module DKX001
- 2 Terminal connection for potential equalization (PE)
- 3 Connecting cable
- 4 Measuring device
- 5 Terminal connection for potential equalization (PE)

6.4 Potential equalization

6.4.1 Requirements

For potential equalization:

- Pay attention to in-house grounding concepts
- Take account of operating conditions like the pipe material and grounding
- Connect the medium, sensor and transmitter to the same electrical potential
- Use a ground cable with a minimum cross-section of 6 mm² (0.0093 in²) and a cable lug for potential equalization connections

6.5 Special connection instructions

6.5.1 Connection examples

Current output 4 to 20 mA HART

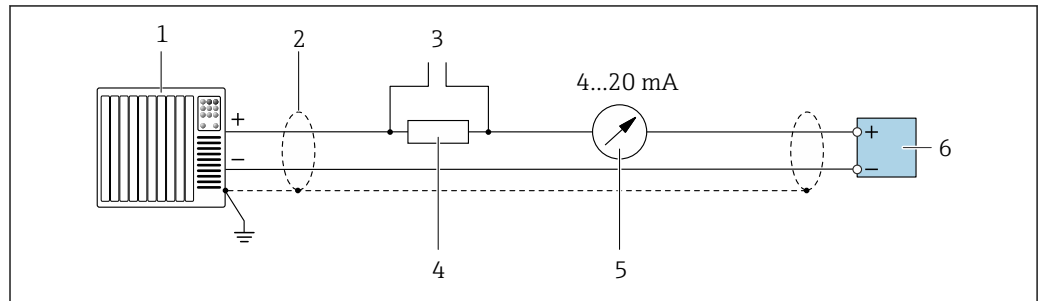

A0029055

20 Connection example for 4 to 20 mA HART current output (active)

- 1 Automation system with current input (e.g. PLC)
- 2 Ground cable shield at one end. The cable shield must be grounded at both ends to comply with EMC requirements; observe cable specifications → 184
- 3 Connection for HART operating devices → 66
- 4 Resistor for HART communication ($\geq 250 \Omega$): observe maximum load → 178
- 5 Analog display unit: observe maximum load → 178
- 6 Transmitter

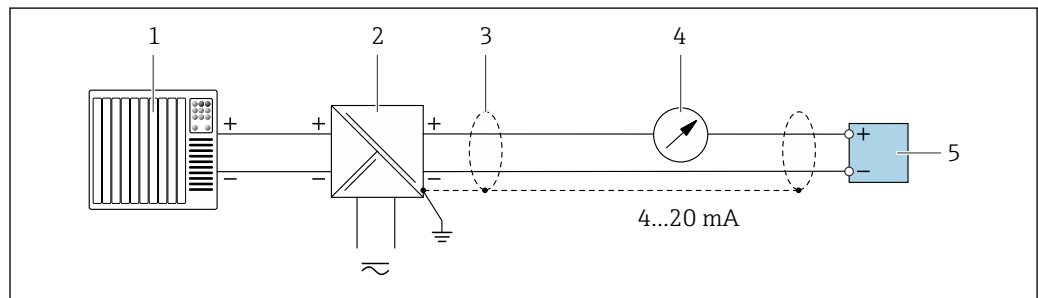

A0028762

21 Connection example for 4 to 20 mA HART current output (passive)

- 1 Automation system with current input (e.g. PLC)
- 2 Power supply
- 3 Ground cable shield at one end. The cable shield must be grounded at both ends to comply with EMC requirements; observe cable specifications
- 4 Analog display unit: observe maximum load → 178
- 5 Transmitter

HART input

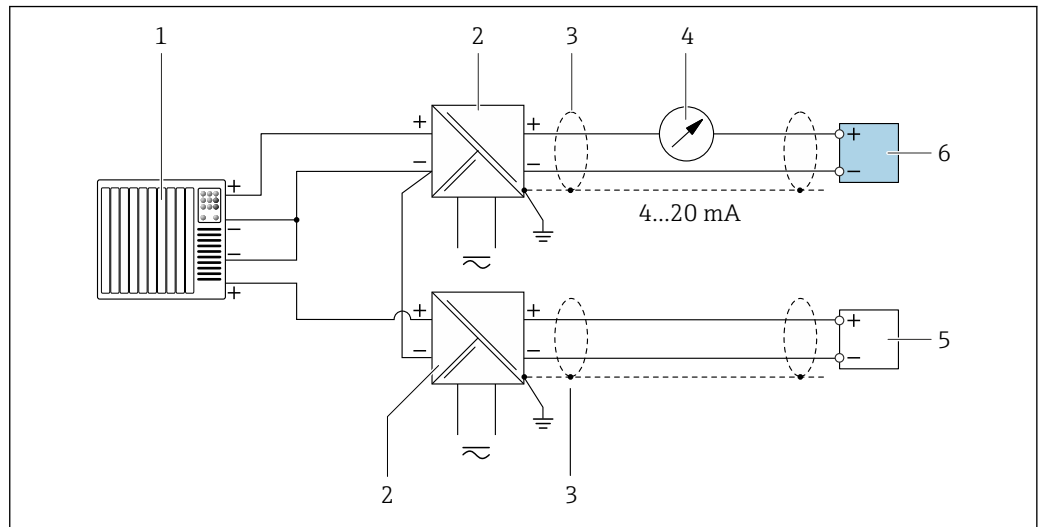

A0028763

22 Connection example for HART input with a common negative (passive)

- 1 Automation system with HART output (e.g. PLC)
- 2 Active barrier for power supply (e.g. RN221N)
- 3 Ground cable shield at one end. The cable shield must be grounded at both ends to comply with EMC requirements; observe cable specifications
- 4 Analog display unit: observe maximum load → 178
- 5 Pressure measuring device (e.g. Cerabar M, Cerabar S): observe requirements
- 6 Transmitter

Current output 4-20 mA

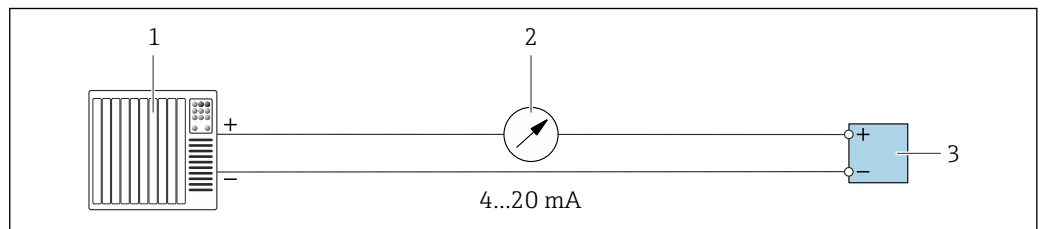

A0028758

23 Connection example for 4-20 mA current output (active)

- 1 Automation system with current input (e.g. PLC)
- 2 Analog display unit: observe maximum load → 178
- 3 Transmitter

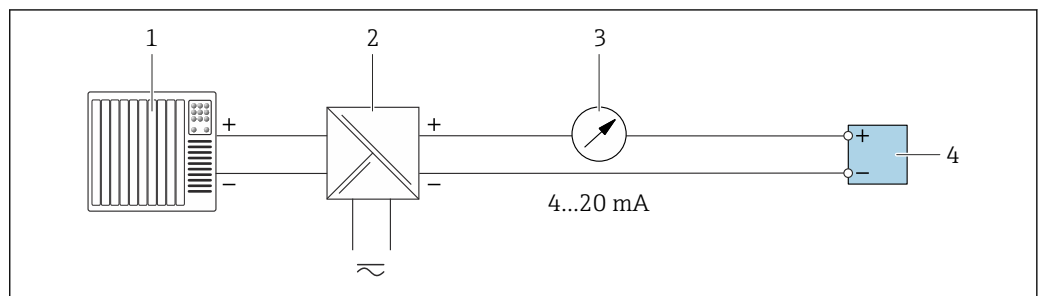

A0028759

24 Connection example for 4-20 mA current output (passive)

- 1 Automation system with current input (e.g. PLC)
- 2 Active barrier for power supply (e.g. RN221N)
- 3 Analog display unit: observe maximum load → 178
- 4 Transmitter

Pulse/frequency output

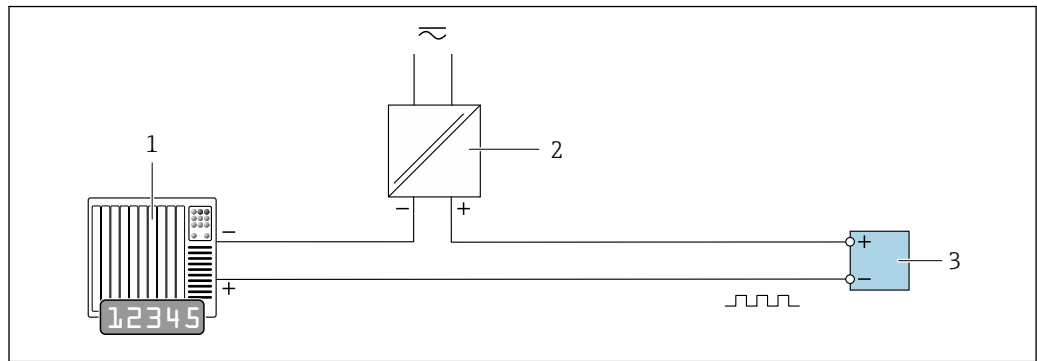

A0028761

25 Connection example for pulse/frequency output (passive)

- 1 Automation system with pulse/frequency input (e.g. PLC with 10 k Ω pull-up or pull-down resistor)
- 2 Power supply
- 3 Transmitter: observe input values → 179

Switch output

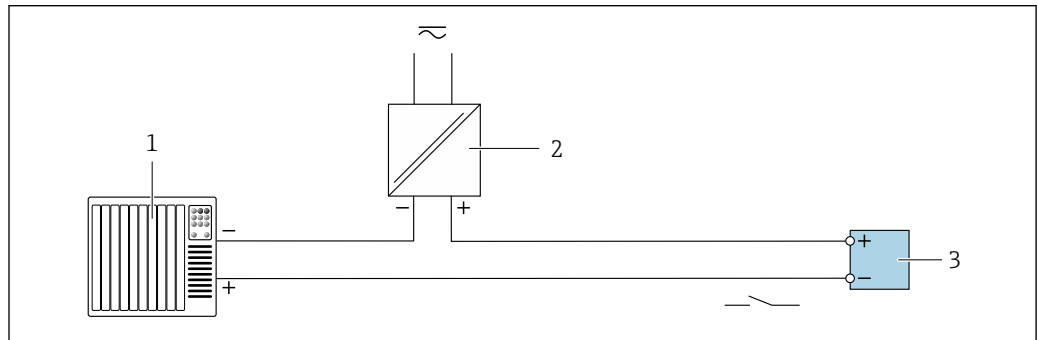

A0028760

26 Connection example for switch output (passive)

- 1 Automation system with switch input (e.g. PLC with a 10 k Ω pull-up or pull-down resistor)
- 2 Power supply
- 3 Transmitter: observe input values → 179

Relay output

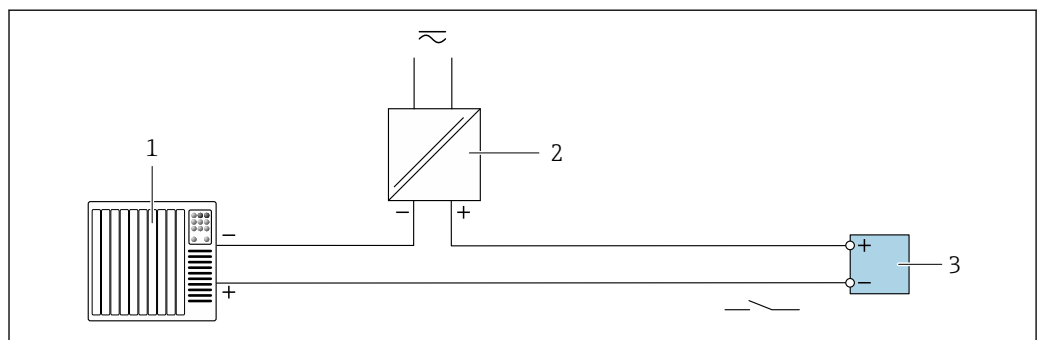

A0028760

27 Connection example for relay output (passive)

- 1 Automation system with relay input (e.g. PLC)
- 2 Power supply
- 3 Transmitter: observe input values → 181

Current input

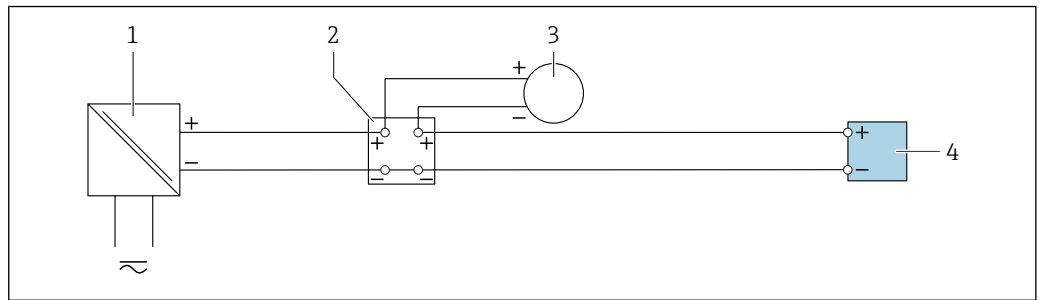

A0028915

▣ 28 Connection example for 4 to 20 mA current input

- 1 Power supply
- 2 Terminal box
- 3 External measuring device (to read in pressure or temperature, for instance)
- 4 Transmitter

Status input

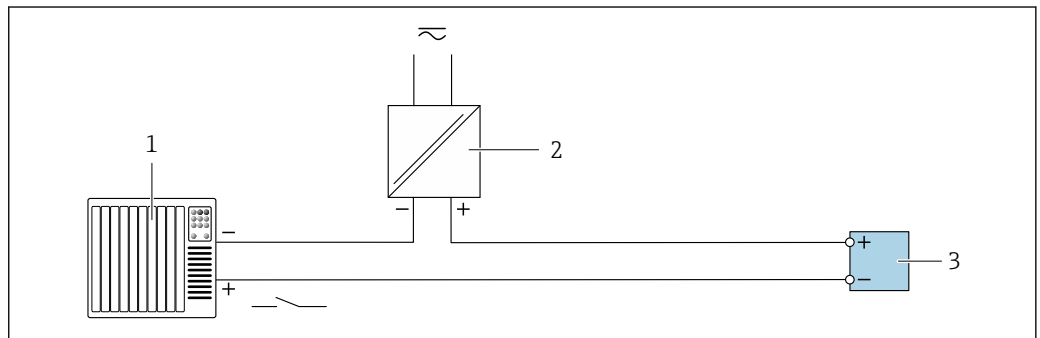

A0028764

▣ 29 Connection example for status input

- 1 Automation system with status output (e.g. PLC)
- 2 Power supply
- 3 Transmitter

6.6 Ensuring the degree of protection

The measuring device fulfills all the requirements for the degree of protection IP66/67, Type 4X enclosure.

To guarantee the degree of protection IP66/67, Type 4X enclosure, carry out the following steps after electrical connection:

1. Check that the housing seals are clean and fitted correctly.
2. Dry, clean or replace the seals if necessary.
3. Tighten all housing screws and screw covers.
4. Firmly tighten the cable glands.

- 5. To ensure that moisture does not enter the cable entry:
Route the cable so that it loops down before the cable entry ("water trap").

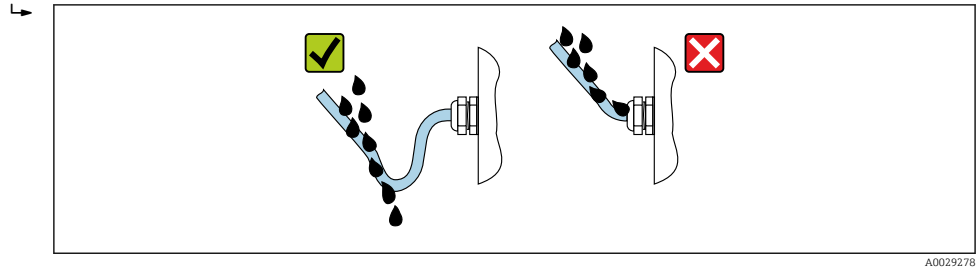

- 6. The cable glands supplied do not ensure housing protection when not in use. They must therefore be replaced by dummy plus corresponding to the housing protection.

6.7 Post-connection check

| | |
|--|--------------------------|
| Are cables or the device undamaged (visual inspection)? | <input type="checkbox"/> |
| Is the protective earthing established correctly? | <input type="checkbox"/> |
| Do the cables used comply with the requirements ? | <input type="checkbox"/> |
| Do the mounted cables have adequate strain relief? | <input type="checkbox"/> |
| Are all cable glands installed, securely tightened and leak-tight? Cable run with "water trap" → 43? | <input type="checkbox"/> |
| Is the terminal assignment correct ? | <input type="checkbox"/> |
| If supply voltage is present, do values appear on the display module? | <input type="checkbox"/> |
| Are dummy plugs inserted in unused cable entries and have transportation plugs been replaced with dummy plugs? | <input type="checkbox"/> |

7 Operation options

7.1 Overview of operation options



A0034513

- 1 Local operation via display module
- 2 Computer with Web browser (e.g. Internet Explorer) or with operating tool (e.g. FieldCare, DeviceCare, AMS Device Manager, SIMATIC PDM)
- 3 Field Xpert SFX350 or SFX370
- 4 Field Xpert SMT70
- 5 Mobile handheld terminal
- 6 Control system (e.g. PLC)

7.2 Structure and function of the operating menu

7.2.1 Structure of the operating menu

 For an overview of the operating menu for experts: see the "Description of Device Parameters" document supplied with the device

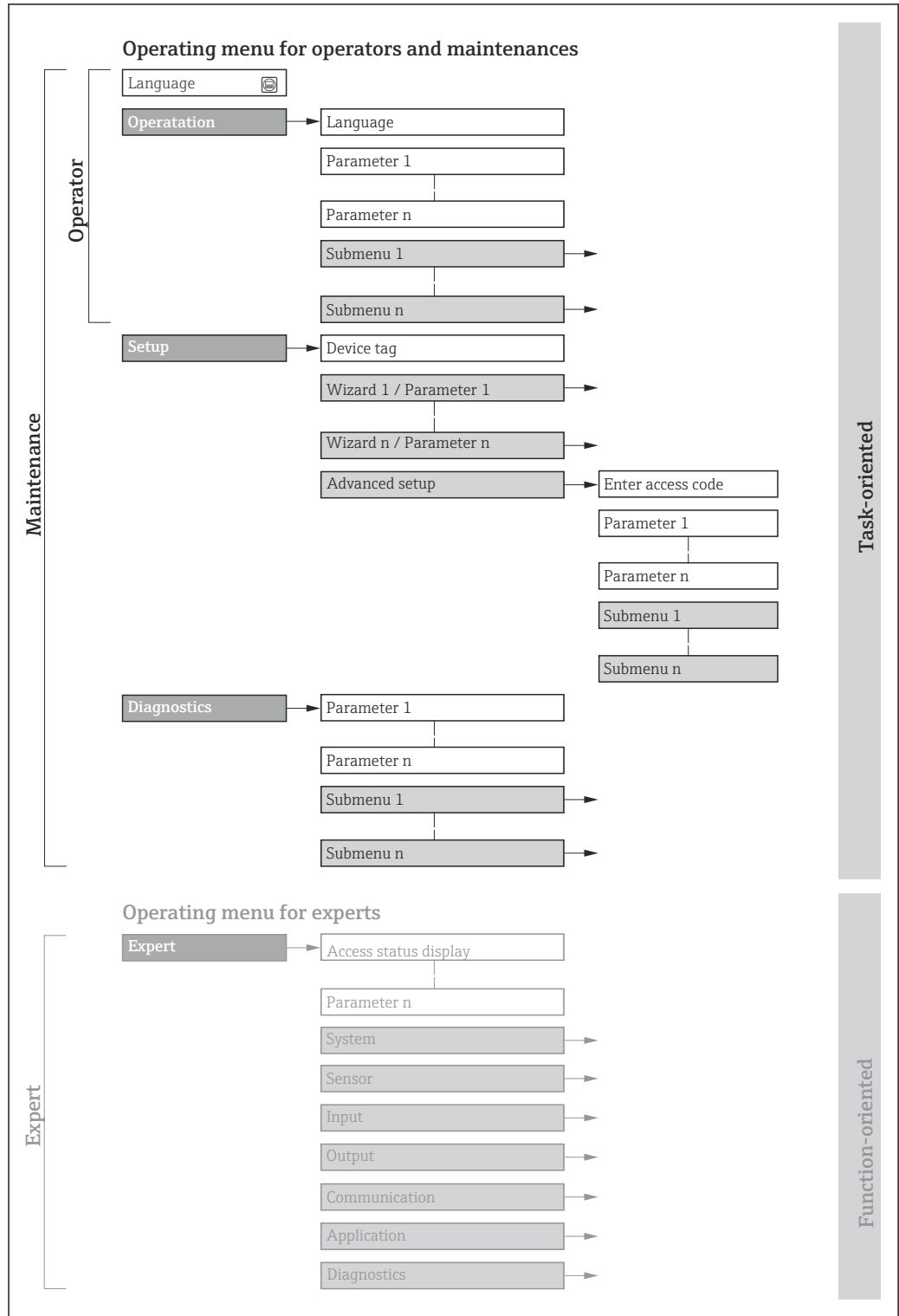

 30 Schematic structure of the operating menu

A0018237-EN

7.2.2 Operating philosophy

The individual parts of the operating menu are assigned to certain user roles (e.g. operator, maintenance etc.). Each user role contains typical tasks within the device life cycle.

| Menu/parameter | | User role and tasks | Content/meaning |
|----------------|-------------------|---|--|
| Language | Task-oriented | Role "Operator", "Maintenance" Tasks during operation: <ul style="list-style-type: none"> Configuration of the operational display Read measured values | <ul style="list-style-type: none"> Define the operating language Define the web server operating language Reset and control totalizers |
| Operation | | | <ul style="list-style-type: none"> Configuration of the operational display (e.g. display format, display contrast) Reset and control totalizers |
| Setup | | "Maintenance" role Commissioning: <ul style="list-style-type: none"> Configuration of the measurement Configuration of the inputs and outputs Configuration of the communication interface | Wizards for fast commissioning: <ul style="list-style-type: none"> Configure the system units Display the I/O configuration Configure the inputs Configure the outputs Configuration of the operational display Configure the low flow cut off Advanced setup <ul style="list-style-type: none"> For more customized configuration of the measurement (adaptation to special measuring conditions) Configuration of totalizers Configuration of WLAN settings Administration (define access code, reset measuring device) |
| Diagnostics | | "Maintenance" role Troubleshooting: <ul style="list-style-type: none"> Diagnostics and elimination of process and device errors Measured value simulation | Contains all parameters for error detection and analyzing process and device errors: <ul style="list-style-type: none"> Diagnostic list <ul style="list-style-type: none"> Contains up to 5 currently pending diagnostic messages. Event logbook <ul style="list-style-type: none"> Contains event messages that have occurred. Device information <ul style="list-style-type: none"> Contains information for identifying the device. Measured values <ul style="list-style-type: none"> Contains all current measured values. Data logging submenu with the "Extended HistoROM" order option <ul style="list-style-type: none"> Storage and visualization of measured values Heartbeat Technology <ul style="list-style-type: none"> The functionality of the device is checked on demand and the verification results are documented. Simulation <ul style="list-style-type: none"> Is used to simulate measured values or output values. |
| Expert | Function-oriented | Tasks that require detailed knowledge of the operating principle of the device: <ul style="list-style-type: none"> Commissioning measurements under difficult conditions Optimal adaptation of the measurement to difficult conditions Detailed configuration of the communication interface Error diagnostics in difficult cases | Contains all the parameters of the device and makes it possible to access these parameters directly using an access code. The structure of this menu is based on the function blocks of the device: <ul style="list-style-type: none"> System <ul style="list-style-type: none"> Contains all higher-level device parameters that do not pertain either to the measurement or to measured value communication. Sensor <ul style="list-style-type: none"> Configuration of the measurement. Input <ul style="list-style-type: none"> Configuration of the status input. Output <ul style="list-style-type: none"> Configuration of the analog current outputs as well as the pulse/frequency and switch output. Communication <ul style="list-style-type: none"> Configuration of the digital communication interface and the web server. Application <ul style="list-style-type: none"> Configuration of the functions that go beyond the actual measurement (e.g. totalizer). Diagnostics <ul style="list-style-type: none"> Error detection and analysis of process and device errors and for device simulation and Heartbeat Technology. |

7.3 Access to operating menu via local display

7.3.1 Operational display

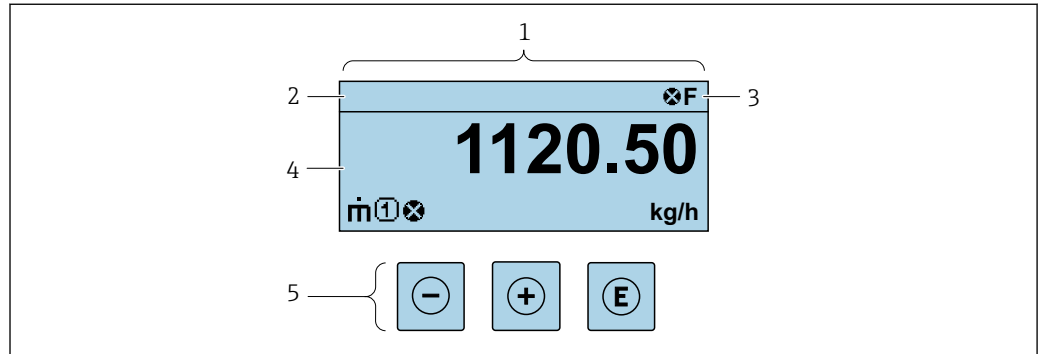

A0029348

- 1 Operational display
- 2 Device tag
- 3 Status area
- 4 Display area for measured values (up to 4 lines)
- 5 Operating elements → 54

Status area

The following symbols appear in the status area of the operational display at the top right:

- Status signals → 142
 - **F**: Failure
 - **C**: Function check
 - **S**: Out of specification
 - **M**: Maintenance required
- Diagnostic behavior → 143
 - : Alarm
 - : Warning
 - : Locking (the device is locked via the hardware)
 - : Communication (communication via remote operation is active)

Display area

In the display area, each measured value is prefaced by certain symbol types for further description:

| | Measured variable | Measurement channel number | Diagnostic behavior |
|---------|-------------------|----------------------------|---------------------|
| | ↓ | ↓ | ↓ |
| Example | | | |

Appears only if a diagnostics event is present for this measured variable.

Measured variables

| Symbol | Meaning |
|--------|---|
| | Mass flow |
| | <ul style="list-style-type: none"> ▪ Volume flow ▪ Corrected volume flow ▪ FAD volume flow |

| | |
|--|--|
| | Heat flow |
| | <ul style="list-style-type: none"> ▪ Density ▪ Reference density |
| | Energy flow |
| | Flow velocity |
| | Calorific value |
| | Temperature |

The number and display format of the measured variables can be configured via the **Format display** parameter (→ 102).

Totalizer

| Symbol | Meaning |
|--------|---|
| | Totalizer The measurement channel number indicates which of the three totalizers is displayed. |

Output

| Symbol | Meaning |
|--------|---|
| | Output The measurement channel number indicates which of the outputs is displayed. |

Input

| Symbol | Meaning |
|--------|--------------|
| | Status input |

Measurement channel numbers

| Symbol | Meaning |
|--------|---|
| | Measurement channel 1 to 4 The measurement channel number is only displayed if more than one channel is present for the same measured variable type (e.g. Totalizer 1 to 3). |

Diagnostic behavior

| Symbol | Meaning |
|--------|---|
| | Alarm <ul style="list-style-type: none"> ▪ Measurement is interrupted. ▪ Signal outputs and totalizers assume the defined alarm condition. ▪ A diagnostic message is generated. |
| | Warning <ul style="list-style-type: none"> ▪ Measurement is resumed. ▪ The signal outputs and totalizers are not affected. ▪ A diagnostic message is generated. |

The diagnostic behavior pertains to a diagnostic event that is relevant to the displayed measured variable.

7.3.2 Navigation view

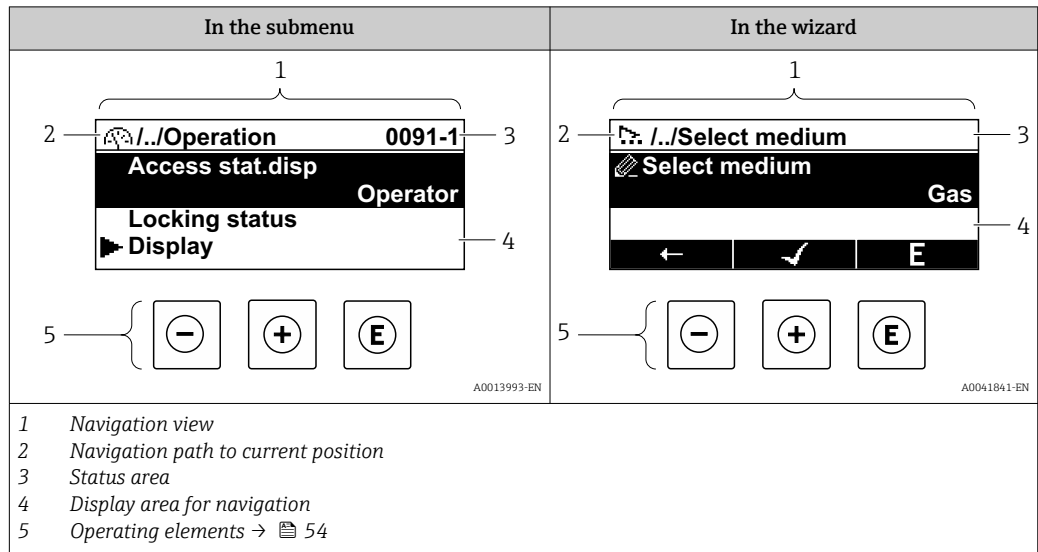

Navigation path

The navigation path to the current position is displayed at the top left in the navigation view and consists of the following elements:

- The display symbol for the menu/submenu (⚙️) or the wizard (🔧).
- An omission symbol (/ ../) for operating menu levels in between.
- Name of the current submenu, wizard or parameter

| | Display symbol | Omission symbol | Parameter |
|---------|----------------|-----------------|-----------|
| | ↓ | ↓ | ↓ |
| Example | ⚙️ | / ../ | Display |

i For more information about the icons in the menu, refer to the "Display area" section → 50

Status area

The following appears in the status area of the navigation view in the top right corner:



- In the submenu
 - The direct access code to the parameter (e.g., 0022-1)
 - If a diagnostic event is present, the diagnostic behavior and status signal
- In the wizard
 - If a diagnostic event is present, the diagnostic behavior and status signal

i ▪ For information on the diagnostic behavior and status signal → 142
 ▪ For information on the function and entry of the direct access code → 56





Display area

Menus

| Symbol | Meaning |
|--------|--|
| ⚙️ | <p>Operation Appears:</p> <ul style="list-style-type: none"> ▪ In the menu next to the "Operation" selection ▪ At the left in the navigation path in the Operation menu |

| | |
|---|---|
|  | <p>Setup Appears:</p> <ul style="list-style-type: none"> ▪ In the menu next to the "Setup" selection ▪ At the left in the navigation path in the Setup menu |
|  | <p>Diagnostics Appears:</p> <ul style="list-style-type: none"> ▪ In the menu next to the "Diagnostics" selection ▪ At the left in the navigation path in the Diagnostics menu |
|  | <p>Expert Appears:</p> <ul style="list-style-type: none"> ▪ In the menu next to the "Expert" selection ▪ At the left in the navigation path in the Expert menu |



Submenus, wizards, parameters

| Symbol | Meaning |
|---|--|
|  | Submenu |
|  | Wizard |
|  | Parameters within a wizard  No display symbol exists for parameters in submenus. |

Locking

| Symbol | Meaning |
|---|---|
|  | <p>Parameter locked When displayed in front of a parameter name, indicates that the parameter is locked.</p> <ul style="list-style-type: none"> ▪ By a user-specific access code ▪ By the hardware write protection switch |

Wizard operation

| Symbol | Meaning |
|---|--|
|  | Switches to the previous parameter. |
|  | Confirms the parameter value and switches to the next parameter. |
|  | Opens the editing view of the parameter. |

7.3.3 Editing view

Numeric editor

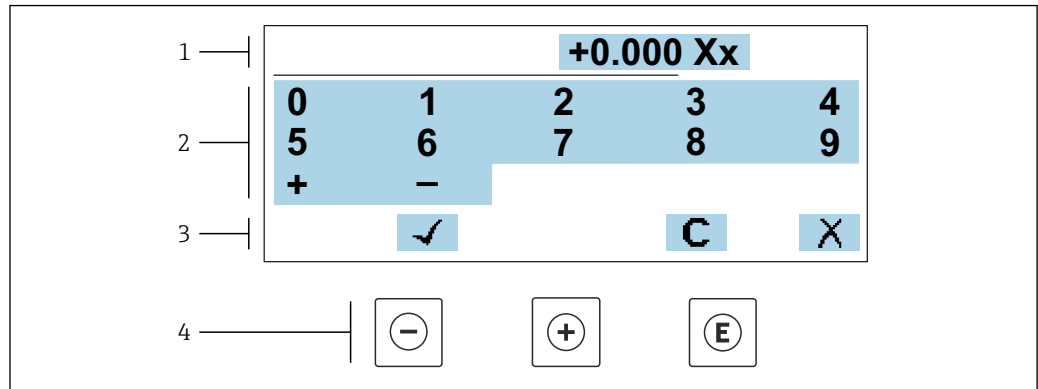

A0034250

31 For entering values in parameters (e.g. limit values)

- 1 Entry display area
- 2 Input screen
- 3 Confirm, delete or reject entry
- 4 Operating elements

Text editor

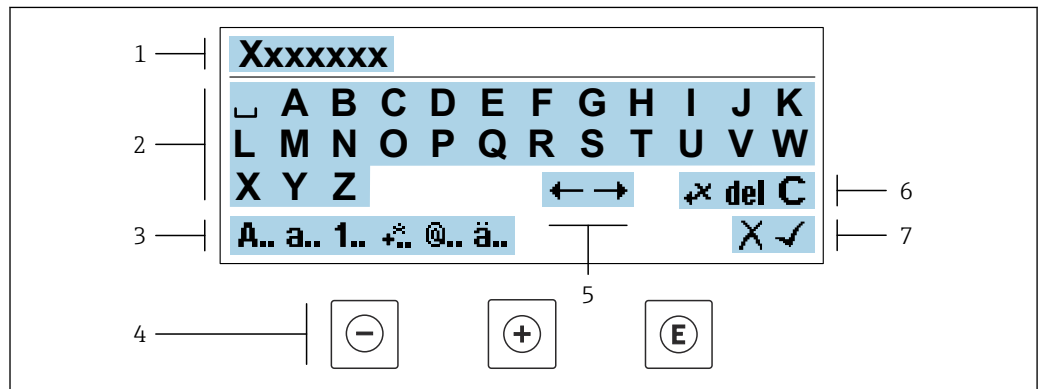

A0034114

32 For entering text in parameters (e.g. device tag)

- 1 Entry display area
- 2 Current input screen
- 3 Change input screen
- 4 Operating elements
- 5 Move entry position
- 6 Delete entry
- 7 Reject or confirm entry

Using the operating elements in the editing view



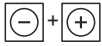

| Operating key | Meaning |
|---------------|--|
| | Minus key Move the entry position to the left. |
| | Plus key Move the entry position to the right. |

| Operating key | Meaning |
|---|---|
|  | Enter key <ul style="list-style-type: none"> Pressing the key briefly confirms your selection. Pressing the key for 2 s confirms your entry. |
|  | Escape key combination (press keys simultaneously) Close the editing view without accepting a change. |





Input screens

| Symbol | Meaning |
|------------|---|
| A.. | Upper case |
| a.. | Lower case |
| 1.. | Numbers |
| +.. | Punctuation marks and special characters: = + - * / ² ³ ¼ ½ ¾ () [] < > { } |
| @.. | Punctuation marks and special characters: " ' ^ . , ; : ? ! % μ ° € \$ £ ¥ § @ # / \ ~ & _ |
| ä.. | Umlauts and accents |

Controlling data entries

| Symbol | Meaning |
|---|---|
|  | Move entry position |
|  | Reject entry |
|  | Confirm entry |
|  | Delete character immediately to the left of the entry position |
| del | Delete character immediately to the right of the entry position |
| C | Clear all the characters entered |

7.3.4 Operating elements

| Operating key | Meaning |
|---|---|
|  | <p>Minus key</p> <p><i>In menu, submenu</i> Moves the selection bar upwards in a picklist.</p> <p><i>With a wizard</i> Confirms the parameter value and goes to the previous parameter.</p> <p><i>In the text and numeric editor</i> Move the entry position to the left.</p> |
|  | <p>Plus key</p> <p><i>In menu, submenu</i> Moves the selection bar downwards in a picklist.</p> <p><i>With a wizard</i> Confirms the parameter value and goes to the next parameter.</p> <p><i>In the text and numeric editor</i> Move the entry position to the right.</p> |
|  | <p>Enter key</p> <p><i>With an operational display</i> Pressing the key briefly opens the operating menu.</p> <p><i>In menu, submenu</i></p> <ul style="list-style-type: none"> ▪ Pressing the key briefly: <ul style="list-style-type: none"> ▪ Opens the selected menu, submenu or parameter. ▪ Starts the wizard. ▪ If help text is open, closes the help text of the parameter. ▪ Pressing the key for 2 s for parameter: <ul style="list-style-type: none"> ▪ If present, opens the help text for the function of the parameter. <p><i>With a Wizard</i> Opens the editing view of the parameter.</p> <p><i>In the text and numeric editor</i></p> <ul style="list-style-type: none"> ▪ Pressing the key briefly confirms your selection. ▪ Pressing the key for 2 s confirms your entry. |
|  | <p>Escape key combination (press keys simultaneously)</p> <p><i>In menu, submenu</i></p> <ul style="list-style-type: none"> ▪ Pressing the key briefly: <ul style="list-style-type: none"> ▪ Exits the current menu level and takes you to the next higher level. ▪ If help text is open, closes the help text of the parameter. ▪ Pressing the key for 2 s returns you to the operational display ("home position"). <p><i>With a wizard</i> Exits the wizard and takes you to the next higher level.</p> <p><i>In the text and numeric editor</i> Exits the Editing view without applying the changes.</p> |
|  | <p>Minus/Enter key combination (press and hold down the keys simultaneously)</p> <ul style="list-style-type: none"> ▪ If keypad lock is active: <ul style="list-style-type: none"> ▪ Pressing the key for 3 s deactivates the keypad lock. ▪ If keypad lock is not active: <ul style="list-style-type: none"> ▪ Pressing the key for 3 s opens the context menu including the option for activating the keypad lock. |



7.3.5 Opening the context menu

Using the context menu, the user can call up the following menus quickly and directly from the operational display:

- Setup
- Data backup
- Simulation



Calling up and closing the context menu

The user is in the operational display.

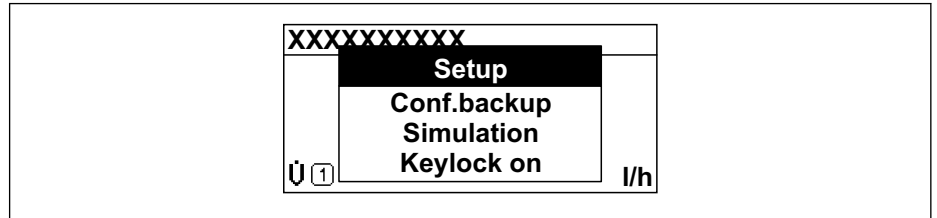

1. Press the  and  keys for longer than 3 seconds.
 - ↳ The context menu opens.



A0034608-EN

2. Press  +  simultaneously.
 - ↳ The context menu is closed and the operational display appears.

Calling up the menu via the context menu

1. Open the context menu.
2. Press  to navigate to the desired menu.
3. Press  to confirm the selection.
 - ↳ The selected menu opens.

7.3.6 Navigating and selecting from list

Different operating elements are used to navigate through the operating menu. The navigation path is displayed on the left in the header. Icons are displayed in front of the individual menus. These icons are also shown in the header during navigation.

i For an explanation of the navigation view with symbols and operating elements → 50

Example: Setting the number of displayed measured values to "2 values"

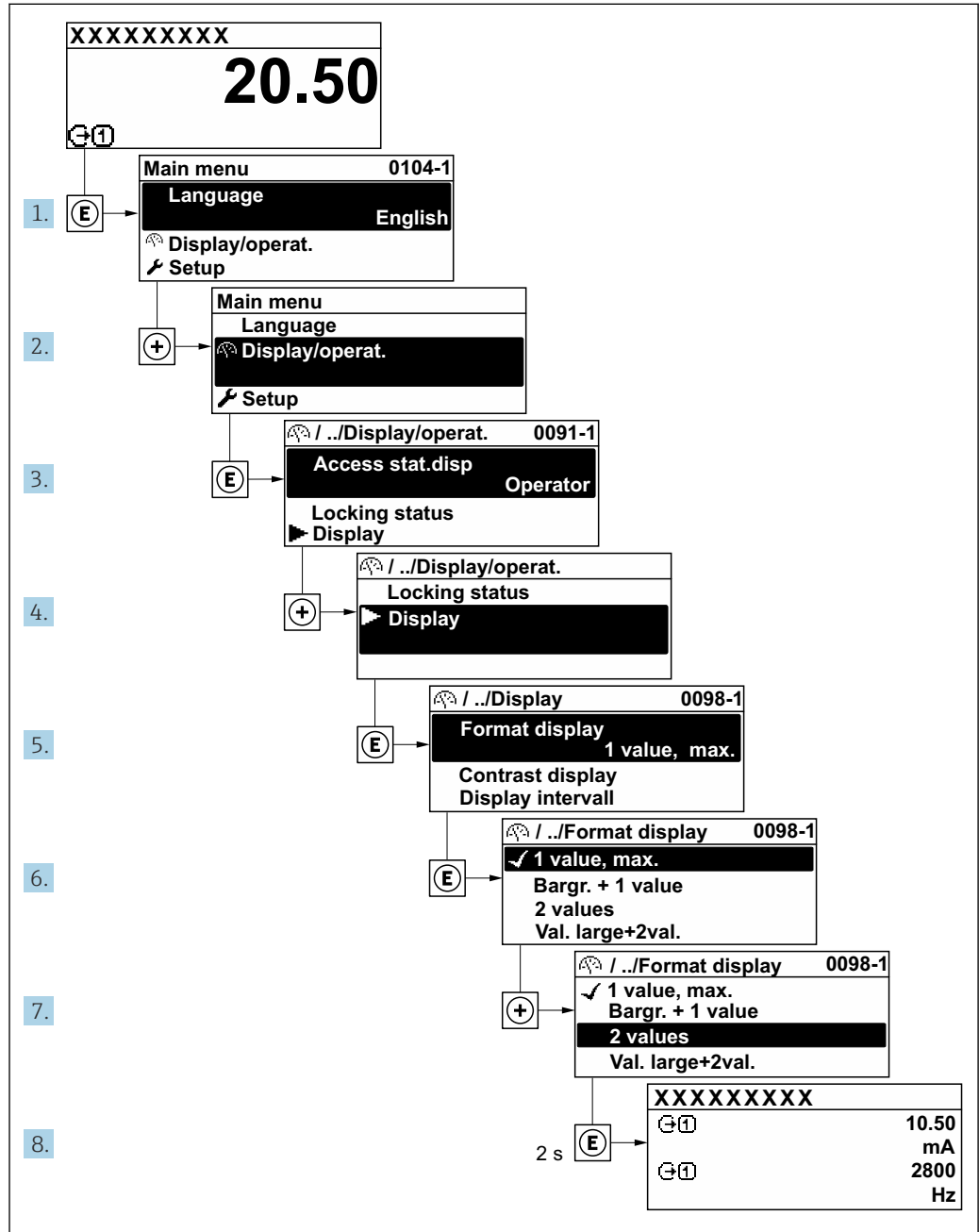

A0029562-EN

7.3.7 Calling the parameter directly

A parameter number is assigned to every parameter to be able to access a parameter directly via the onsite display. Entering this access code in the **Direct access** parameter calls up the desired parameter directly.

Navigation path

Expert → Direct access

The direct access code consists of a 5-digit number (at maximum) and the channel number, which identifies the channel of a process variable: e.g. 00914-2. In the navigation view, this appears on the right-hand side in the header of the selected parameter.

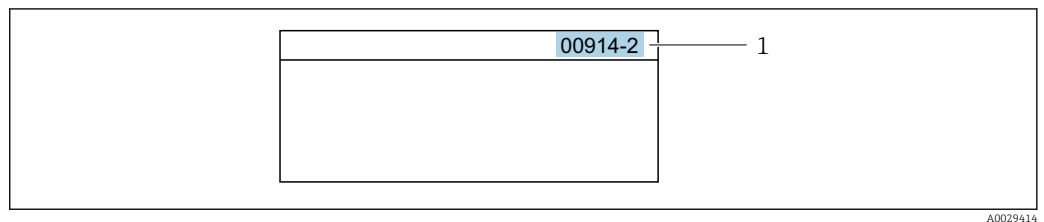

1 Direct access code

Note the following when entering the direct access code:

- The leading zeros in the direct access code do not have to be entered.
Example: Enter "914" instead of "00914"
- If no channel number is entered, channel 1 is opened automatically.
Example: Enter 00914 → **Assign process variable** parameter
- If a different channel is opened: Enter the direct access code with the corresponding channel number.
Example: Enter 00914-2 → **Assign process variable** parameter



For the direct access codes of the individual parameters, see the "Description of Device Parameters" document for the device

7.3.8 Calling up help text

Help text is available for some parameters and can be called up from the navigation view. The help text provides a brief explanation of the parameter function and thereby supports swift and safe commissioning.



Calling up and closing the help text

The user is in the navigation view and the selection bar is on a parameter.

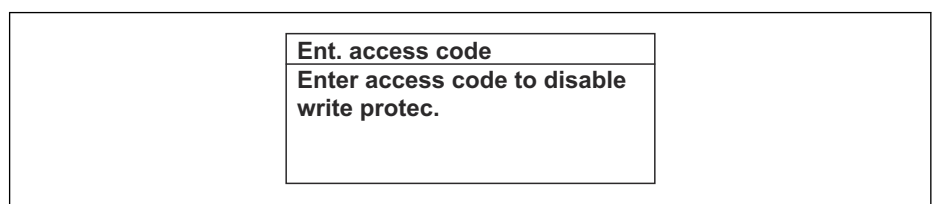
1. Press  for 2 s.
↳ The help text for the selected parameter opens.



 33 Example: Help text for parameter "Enter access code"

2. Press  +  simultaneously.
↳ The help text is closed.

7.3.9 Changing the parameters

Parameters can be changed via the numeric editor or text editor.

- Numeric editor: Change values in a parameter, e.g. specifications for limit values.
- Text editor: Enter text in a parameter, e.g. tag name.

A message is displayed if the value entered is outside the permitted value range.

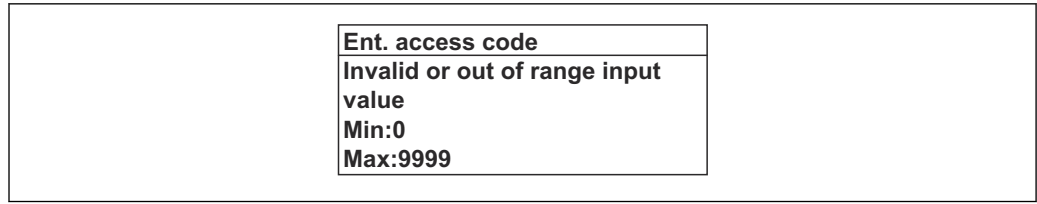

A0014049-EN

i For a description of the editing view - consisting of the text editor and numeric editor - with symbols → 52, for a description of the operating elements → 54

7.3.10 User roles and related access authorization

The two user roles "Operator" and "Maintenance" have different write access to the parameters if the customer defines a user-specific access code. This protects the device configuration via the local display from unauthorized access → 124.

Defining access authorization for user roles

An access code is not yet defined when the device is delivered from the factory. Access authorization (read and write access) to the device is not restricted and corresponds to the "Maintenance" user role.

- ▶ Define the access code.
 - ↳ The "Operator" user role is redefined in addition to the "Maintenance" user role. Access authorization differs for the two user roles.

Access authorization to parameters: "Maintenance" user role

| Access code status | Read access | Write access |
|--|-------------|-----------------|
| An access code has not yet been defined (factory setting). | ✓ | ✓ |
| After an access code has been defined. | ✓ | ✓ ¹⁾ |

1) The user only has write access after entering the access code.

Access authorization to parameters: "Operator" user role

| Access code status | Read access | Write access |
|--|-------------|-----------------|
| After an access code has been defined. | ✓ | _ ¹⁾ |

1) Despite the defined access code, certain parameters can always be modified and thus are excluded from the write protection as they do not affect the measurement: write protection via access code → 124

i The user role with which the user is currently logged on is indicated by the **Access status** parameter. Navigation path: Operation → Access status

7.3.11 Disabling write protection via access code

If the -symbol appears on the local display in front of a parameter, the parameter is write-protected by a user-specific access code and its value cannot be changed at the moment using local operation → 124.

Parameter write protection via local operation can be disabled by entering the user-specific access code in the **Enter access code** parameter (→ 105) via the respective access option.

1. After you press , the input prompt for the access code appears.

2. Enter the access code.
 - ↳ The -symbol in front of the parameters disappears; all previously write-protected parameters are now re-enabled.

7.3.12 Enabling and disabling the keypad lock



The keypad lock makes it possible to block access to the entire operating menu via local operation. As a result, it is no longer possible to navigate through the operating menu or change the values of individual parameters. Users can only read the measured values on the operational display.

The keypad lock is switched on and off via the context menu.

Switching on the keypad lock



-  The keypad lock is switched on automatically:
- If the device has not been operated via the display for > 1 minute.
 - Each time the device is restarted.

To activate the keylock manually:

1. The device is in the measured value display.
Press the  and  keys for 3 seconds.
 - ↳ A context menu appears.
2. In the context menu select the **Keylock on** option.
 - ↳ The keypad lock is switched on.

-  If the user attempts to access the operating menu while the keypad lock is active, the **Keylock on** message appears.

Switching off the keypad lock

- ▶ The keypad lock is switched on.
Press the  and  keys for 3 seconds.
 - ↳ The keypad lock is switched off.

7.4 Access to operating menu via web browser

7.4.1 Function range

With the integrated web server, the device can be operated and configured via a web browser service interface (CDI-RJ45) or WLAN interface. The structure of the operating menu is the same as for the local display. In addition to the measured values, status information on the device is displayed and can be used to monitor device health. Furthermore the device data can be managed and the network parameters can be configured.

A device that has a WLAN interface (can be ordered as an option) is required for the WLAN connection: order code for "Display; operation", option G "4-line, illuminated; touch control + WLAN". The device acts as an Access Point and enables communication by computer or a mobile handheld terminal.

-  For additional information on the web server, refer to the Special Documentation for the device →  203 (Verweisziel existiert nicht, aber @y.link.required=true)

7.4.2 Requirements

Computer hardware



| Hardware | Interface | |
|------------|---|--|
| | CDI-RJ45 | WLAN |
| Interface | The computer must have a RJ45 interface. ¹⁾ | The operating unit must have a WLAN interface. |
| Connection | Standard Ethernet cable | Connection via Wireless LAN. |
| Screen | Recommended size: ≥12" (depends on the screen resolution) | |

- 1) Recommended cable: CAT5e, CAT6 or CAT7, with shielded plug (e.g. YAMAICHI product; part no. Y-ConProfixPlug63/Prod. ID: 82-006660)

Computer software



| Software | Interface | |
|-------------------------------|---|------|
| | CDI-RJ45 | WLAN |
| Recommended operating systems | <ul style="list-style-type: none"> ▪ Microsoft Windows 8 or higher. ▪ Mobile operating systems: <ul style="list-style-type: none"> ▪ iOS ▪ Android <p> Microsoft Windows XP and Windows 7 is supported.</p> | |
| Web browsers supported | <ul style="list-style-type: none"> ▪ Microsoft Internet Explorer 8 or higher ▪ Microsoft Edge ▪ Mozilla Firefox ▪ Google Chrome ▪ Safari | |

Computer settings



| Settings | Interface | |
|--|---|---|
| | CDI-RJ45 | WLAN |
| User rights | Appropriate user rights (e.g. administrator rights) for TCP/IP and proxy server settings are necessary (e.g. for adjusting the IP address, subnet mask etc.). | |
| Proxy server settings of the web browser | The web browser's <i>Use a Proxy Server for Your LAN</i> setting must be deselected . | |
| JavaScript | <p>JavaScript must be enabled.</p> <p> If JavaScript cannot be enabled: Enter <code>http://192.168.1.212/servlet/basic.html</code> in the address bar of the web browser. A fully functional but simplified version of the operating menu structure starts in the web browser.</p> <p> When installing a new firmware version: To enable correct data display, clear the temporary memory (cache) under Internet options in the web browser.</p> | |
| Network connections | Use only the active network connections for the measuring device. | |
| | Switch off all other network connections such as WLAN for example. | Switch off all other network connections. |

 In the event of connection problems: →  139

Measuring device: Via CDI-RJ45 service interface

| Device | CDI-RJ45 service interface |
|------------------|--|
| Measuring device | The measuring device has an RJ45 interface. |
| Web server | Web server must be enabled; factory setting: ON  For information on enabling the Web server →  65 |

Measuring device: via WLAN interface

| Device | WLAN interface |
|------------------|---|
| Measuring device | The measuring device has a WLAN antenna: <ul style="list-style-type: none"> ▪ Transmitter with integrated WLAN antenna ▪ Transmitter with external WLAN antenna |
| Web server | Web server and WLAN must be enabled; factory setting: ON  For information on enabling the Web server →  65 |

7.4.3 Establishing a connection

Via service interface (CDI-RJ45)

Preparing the measuring device

1. Depending on the housing version:
Loosen the securing clamp or fixing screw of the housing cover.
2. Depending on the housing version:
Unscrew or open the housing cover.
3. Connect the computer to the RJ45 plug via the standard Ethernet cable .

Configuring the Internet protocol of the computer

The following information refers to the default Ethernet settings of the device.

IP address of the device: 192.168.1.212 (factory setting)

1. Switch on the measuring device.
2. Connect the computer to the RJ45 plug via the standard Ethernet cable →  67.
3. If a 2nd network card is not used, close all the applications on the notebook.
 - ↳ Applications requiring Internet or a network, such as e-mail, SAP applications, Internet or Windows Explorer.
4. Close any open Internet browsers.
5. Configure the properties of the Internet protocol (TCP/IP) as defined in the table:

| | |
|-----------------|--|
| IP address | 192.168.1.XXX; for XXX all numerical sequences except: 0, 212 and 255 → e.g. 192.168.1.213 |
| Subnet mask | 255.255.255.0 |
| Default gateway | 192.168.1.212 or leave cells empty |

Via WLAN interface

Configuring the Internet protocol of the mobile terminal

NOTICE

If the WLAN connection is lost during the configuration, settings made may be lost.

- ▶ Make sure that the WLAN connection is not disconnected while configuring the device.

NOTICE**Note the following to avoid a network conflict:**

- ▶ Avoid accessing the measuring device simultaneously from the same mobile terminal via the service interface (CDI-RJ45) and the WLAN interface.
- ▶ Only activate one service interface (CDI-RJ45 or WLAN interface).
- ▶ If simultaneous communication is necessary: configure different IP address ranges, e.g. 192.168.0.1 (WLAN interface) and 192.168.1.212 (CDI-RJ45 service interface).

Preparing the mobile terminal

- ▶ Enable WLAN on the mobile terminal.

Establishing a WLAN connection from the mobile terminal to the measuring device

1. In the WLAN settings of the mobile terminal:
Select the measuring device using the SSID (e.g. EH_t-mass_300_A802000).
2. If necessary, select the WPA2 encryption method.
3. Enter the password:
Serial number of the measuring device ex-works (e.g. L100A802000).
 - ↳ The LED on the display module flashes. It is now possible to operate the measuring device with the web browser, FieldCare or DeviceCare.

 The serial number can be found on the nameplate.

 To ensure the safe and swift assignment of the WLAN network to the measuring point, it is advisable to change the SSID name. It should be possible to clearly assign the new SSID name to the measuring point (e.g. tag name) because it is displayed as the WLAN network.

Terminating the WLAN connection

- ▶ After configuring the device:
Terminate the WLAN connection between the mobile terminal and measuring device.

Starting the Web browser

1. Start the Web browser on the computer.

2. Enter the IP address of the web server in the address line of the web browser:
192.168.1.212
↳ The login page appears.

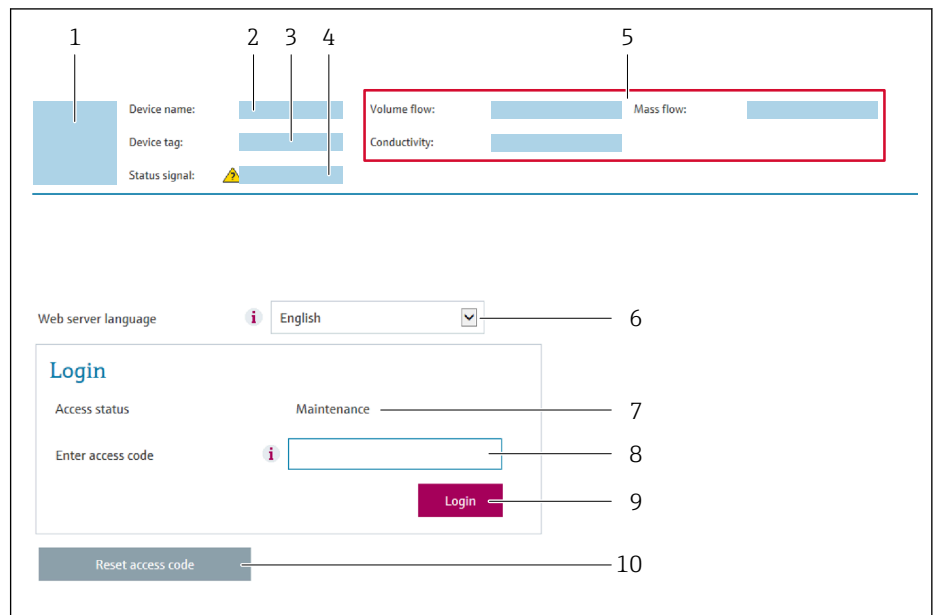

A0029417

- 1 Picture of device
- 2 Device name
- 3 Device tag (→ ⓘ 80)
- 4 Status signal
- 5 Current measured values
- 6 Operating language
- 7 User role
- 8 Access code
- 9 Login
- 10 Reset access code (→ ⓘ 114)

i If a login page does not appear, or if the page is incomplete → ⓘ 139

7.4.4 Logging on

1. Select the preferred operating language for the Web browser.
2. Enter the user-specific access code.
3. Press **OK** to confirm your entry.

| | |
|--------------------|--|
| Access code | 0000 (factory setting); can be changed by customer |
|--------------------|--|

i If no action is performed for 10 minutes, the Web browser automatically returns to the login page.

7.4.5 User interface

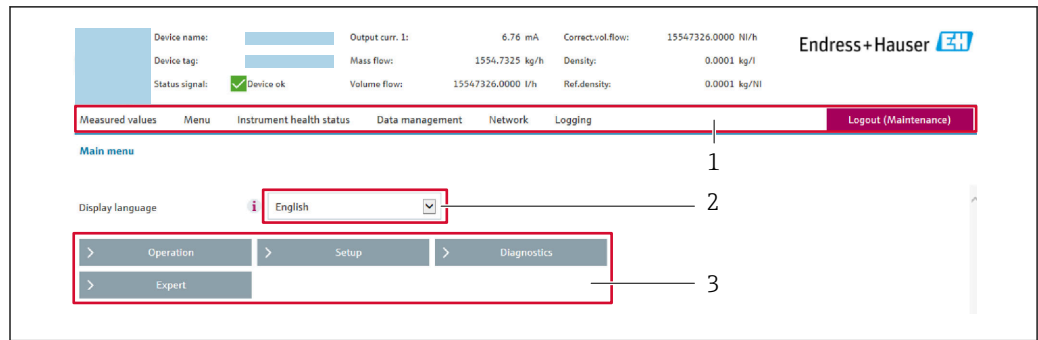

A0029418

- 1 Function row
- 2 Local display language
- 3 Navigation area

Header

The following information appears in the header:

- Device name
- Device tag
- Device status with status signal → 📄 145
- Current measured values

Function row

| Functions | Meaning |
|-----------------|---|
| Measured values | Displays the measured values of the device |
| Menu | <ul style="list-style-type: none"> ■ Access to the operating menu from the measuring device ■ The structure of the operating menu is the same as for the local display  Detailed information on the structure of the operating menu: see the Description of Device Parameters |
| Device status | Displays the diagnostic messages currently pending, listed in order of priority |
| Data management | Data exchange between computer and measuring device: <ul style="list-style-type: none"> ■ Device configuration: <ul style="list-style-type: none"> ■ Load settings from the device (XML format, save configuration) ■ Save settings to the device (XML format, restore configuration) ■ Logbook - Export Event logbook (.csv file) ■ Documents - Export documents: <ul style="list-style-type: none"> ■ Export backup data record (.csv file, create documentation of the measuring point configuration) ■ Verification report (PDF file, only available with the "Heartbeat Verification" application package) ■ Firmware update - Flashing a firmware version |
| Network | Configuration and checking of all the parameters required for establishing the connection to the measuring device: <ul style="list-style-type: none"> ■ Network settings (e.g. IP address, MAC address) ■ Device information (e.g. serial number, firmware version) |
| Logout | End the operation and call up the login page |

Navigation area

The menus, the associated submenus and parameters can be selected in the navigation area.

Working area

Depending on the selected function and the related submenus, various actions can be performed in this area:

- Configuring parameters
- Reading measured values
- Calling up help text
- Starting an upload/download

7.4.6 Disabling the Web server

The Web server of the measuring device can be switched on and off as required using the **Web server functionality** parameter.

Navigation

"Expert" menu → Communication → Web server

Parameter overview with brief description

| Parameter | Description | Selection |
|--------------------------|-----------------------------------|---|
| Web server functionality | Switch the Web server on and off. | <ul style="list-style-type: none"> ■ Off ■ HTML Off ■ On |

Function scope of the "Web server functionality" parameter

| Option | Description |
|--------|---|
| Off | <ul style="list-style-type: none"> ■ The Web server is completely disabled. ■ Port 80 is locked. |
| On | <ul style="list-style-type: none"> ■ The complete Web server functionality is available. ■ JavaScript is used. ■ The password is transferred in an encrypted state. ■ Any change to the password is also transferred in an encrypted state. |

Enabling the Web server

If the Web server is disabled it can only be re-enabled with the **Web server functionality** parameter via the following operating options:

- Via local display
- Via Bedientool "FieldCare"
- Via "DeviceCare" operating tool

7.4.7 Logging out

 Before logging out, perform a data backup via the **Data management** function (upload configuration from device) if necessary.

1. Select the **Logout** entry in the function row.
 - ↳ The home page with the Login box appears.
2. Close the Web browser.
3. If no longer needed:
 - Reset the modified properties of the Internet protocol (TCP/IP) →  61.

7.5 Access to the operating menu via the operating tool

The structure of the operating menu in the operating tools is the same as for operation via the local display.

7.5.1 Connecting the operating tool

Via HART protocol

This communication interface is available in device versions with a HART output.

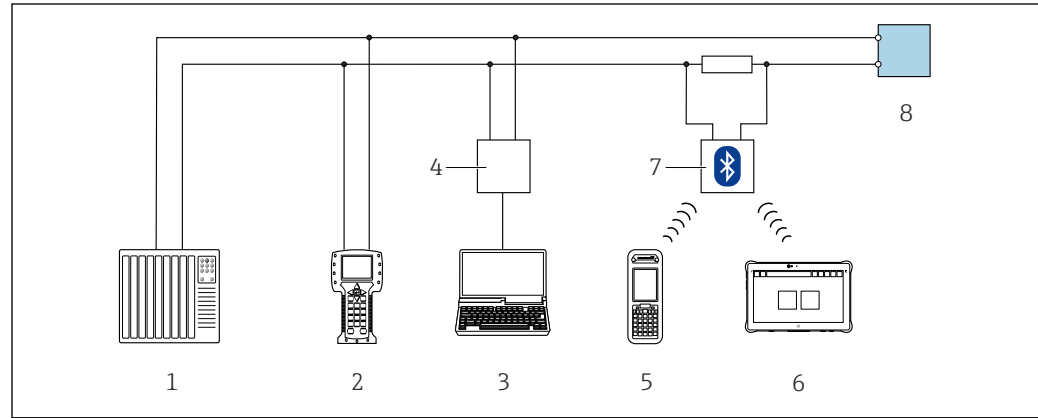

34 Options for remote operation via HART protocol (active)

- 1 Control system (e.g. PLC)
- 2 Field Communicator 475
- 3 Computer with web browser (e.g. Microsoft Edge) to access the integrated device web server or computer with operating tool (e.g. FieldCare, DeviceCare, AMS Device Manager, SIMATIC PDM) with COM DTM "CDI Communication TCP/IP"
- 4 Commubox FXA 195 (USB)
- 5 Field Xpert SFX350 or SFX370
- 6 Field Xpert SMT70
- 7 VIATOR Bluetooth modem with connecting cable
- 8 Transmitter

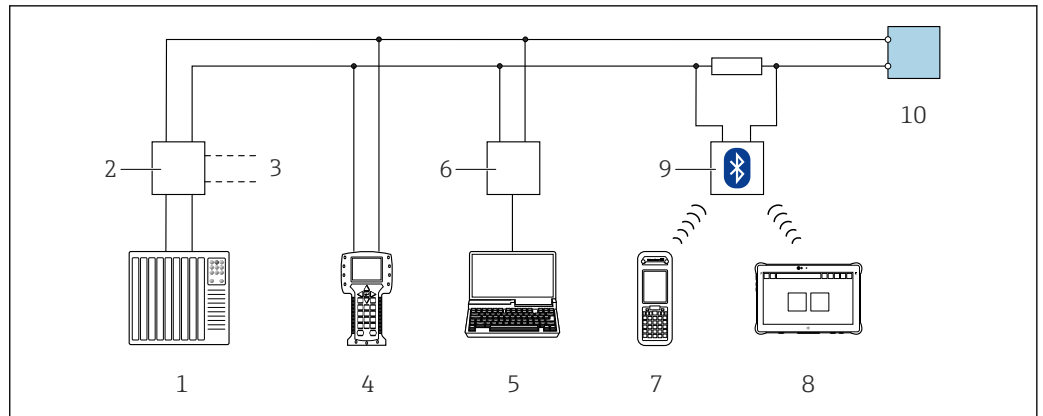

A0028746

35 Options for remote operation via HART protocol (passive)

- 1 Control system (e.g. PLC)
- 2 Transmitter power supply unit, e.g. RN221N (with communication resistor)
- 3 Connection for Commubox FXA195 and Field Communicator 475
- 4 Field Communicator 475
- 5 Computer with web browser (e.g. Microsoft Edge) to access the integrated device web server or computer with operating tool (e.g. FieldCare, DeviceCare, AMS Device Manager, SIMATIC PDM) with COM DTM "CDI Communication TCP/IP"
- 6 Commubox FXA195 (USB)
- 7 Field Xpert SFX350 or SFX370
- 8 Field Xpert SMT70
- 9 VIATOR Bluetooth modem with connecting cable
- 10 Transmitter

Service interface

Via service interface (CDI-RJ45)

A point-to-point connection can be established to configure the device on site. With the housing open, the connection is established directly via the service interface (CDI-RJ45) of the device.

i An adapter for the RJ45 to the M12 plug is optionally available for the non-hazardous area:

Order code for "Accessories", option **NB**: "Adapter RJ45 M12 (service interface)"

The adapter connects the service interface (CDI-RJ45) to an M12 plug mounted in the cable entry. The connection to the service interface can be established via an M12 plug without opening the device.

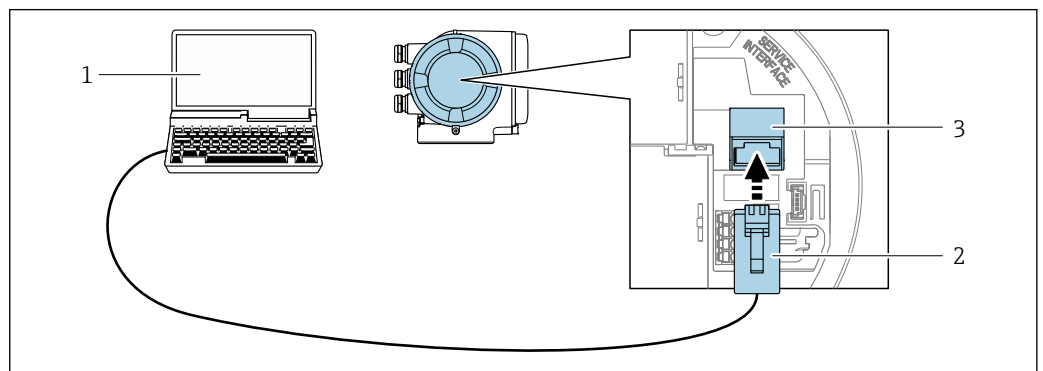

A0027563

36 Connection via service interface (CDI-RJ45)

- 1 Computer with web browser (e.g. Microsoft Internet Explorer, Microsoft Edge) to access the integrated web server or with an operating tool "FieldCare", "DeviceCare" with COM DTM "CDI Communication TCP/IP"
- 2 Standard Ethernet connecting cable with RJ45 plug
- 3 Service interface (CDI-RJ45) of the measuring device with access to the integrated web server

Via WLAN interface

The optional WLAN interface is available on the following device version:

Order code for "Display; operation", option G "4-line, illuminated; touch control + WLAN"

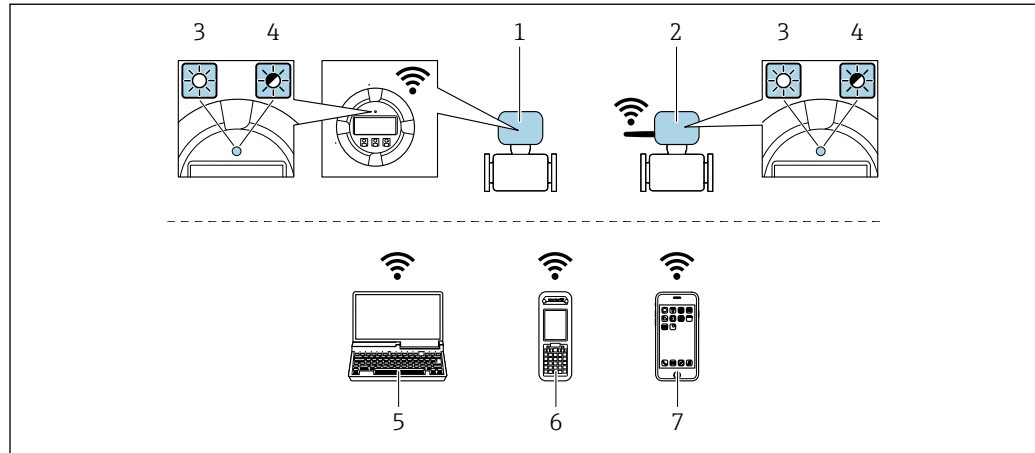

A0034570

- 1 Transmitter with integrated WLAN antenna
- 2 Transmitter with external WLAN antenna
- 3 LED lit constantly: WLAN reception is enabled on measuring device
- 4 LED flashing: WLAN connection established between operating unit and measuring device
- 5 Computer with WLAN interface and web browser (e.g. Microsoft Internet Explorer, Microsoft Edge) for accessing the integrated device web server or with operating tool (e.g. FieldCare, DeviceCare)
- 6 Mobile handheld terminal with WLAN interface and web browser (e.g. Microsoft Internet Explorer, Microsoft Edge) for accessing the integrated device web server or operating tool (e.g. FieldCare, DeviceCare)
- 7 Smart phone or tablet (e.g. Field Xpert SMT70)

| | |
|------------------------------|--|
| Function | WLAN: IEEE 802.11 b/g (2.4 GHz) |
| Encryption | WPA2-PSK AES-128 (in accordance with IEEE 802.11i) |
| Configurable WLAN channels | 1 to 11 |
| Degree of protection | IP67 |
| Available antennas | <ul style="list-style-type: none"> ▪ Internal antenna ▪ External antenna (optional) <p>In the event of poor transmission/reception conditions at the place of installation.</p> <p> Only 1 antenna is active at any one time!</p> |
| Range | <ul style="list-style-type: none"> ▪ Internal antenna: typically 10 m (32 ft) ▪ External antenna: typically 50 m (164 ft) |
| Materials (external antenna) | <ul style="list-style-type: none"> ▪ Antenna: ASA plastic (acrylonitrile styrene acrylate) and nickel-plated brass ▪ Adapter: Stainless steel and nickel-plated brass ▪ Cable: Polyethylene ▪ Plug: Nickel-plated brass ▪ Angle bracket: Stainless steel |

Configuring the Internet protocol of the mobile terminal

NOTICE

If the WLAN connection is lost during the configuration, settings made may be lost.

- ▶ Make sure that the WLAN connection is not disconnected while configuring the device.

NOTICE**Note the following to avoid a network conflict:**

- ▶ Avoid accessing the measuring device simultaneously from the same mobile terminal via the service interface (CDI-RJ45) and the WLAN interface.
- ▶ Only activate one service interface (CDI-RJ45 or WLAN interface).
- ▶ If simultaneous communication is necessary: configure different IP address ranges, e.g. 192.168.0.1 (WLAN interface) and 192.168.1.212 (CDI-RJ45 service interface).

Preparing the mobile terminal

- ▶ Enable WLAN on the mobile terminal.

Establishing a WLAN connection from the mobile terminal to the measuring device

1. In the WLAN settings of the mobile terminal:
Select the measuring device using the SSID (e.g. EH_t-mass_300_A802000).
2. If necessary, select the WPA2 encryption method.
3. Enter the password:
Serial number of the measuring device ex-works (e.g. L100A802000).
↳ The LED on the display module flashes. It is now possible to operate the measuring device with the web browser, FieldCare or DeviceCare.



The serial number can be found on the nameplate.



To ensure the safe and swift assignment of the WLAN network to the measuring point, it is advisable to change the SSID name. It should be possible to clearly assign the new SSID name to the measuring point (e.g. tag name) because it is displayed as the WLAN network.

Terminating the WLAN connection

- ▶ After configuring the device:
Terminate the WLAN connection between the mobile terminal and measuring device.

7.5.2 Field Xpert SFX350, SFX370**Function scope**

Field Xpert SFX350 and Field Xpert SFX370 are mobile computers for commissioning and maintenance. They enable efficient device configuration and diagnostics for HART and FOUNDATION Fieldbus devices in the **non-hazardous area** (SFX350, SFX370) and **hazardous area** (SFX370).



For details, see Operating Instructions BA01202S



Source for device description files

See information → 73

7.5.3 FieldCare**Function range**

FDT-based (Field Device Technology) plant asset management tool from Endress+Hauser. It can configure all smart field units in a system and helps you manage them. By using the status information, it is also a simple but effective way of checking their status and condition.

Access is via:

- HART protocol →  66
- CDI-RJ45 service interface →  67
- WLAN interface →  68

Typical functions:

- Transmitter parameter configuration
- Loading and saving of device data (upload/download)
- Documentation of the measuring point
- Visualization of the measured value memory (line recorder) and event logbook



- Operating Instructions BA00027S
- Operating Instructions BA00059S



- Source for device description files →  73

Establishing a connection

1. Start FieldCare and launch the project.
2. In the network: Add a device.
 - ↳ The **Add device** window opens.
3. Select the **CDI Communication TCP/IP** option from the list and press **OK** to confirm.
4. Right-click **CDI Communication TCP/IP** and select the **Add device** option in the context menu that opens.
5. Select the desired device from the list and press **OK** to confirm.
 - ↳ The **CDI Communication TCP/IP (Configuration)** window opens.
6. Enter the device address in the **IP address** field: 192.168.1.212 and press **Enter** to confirm.
7. Establish the online connection to the device.



- Operating Instructions BA00027S
- Operating Instructions BA00059S

User interface

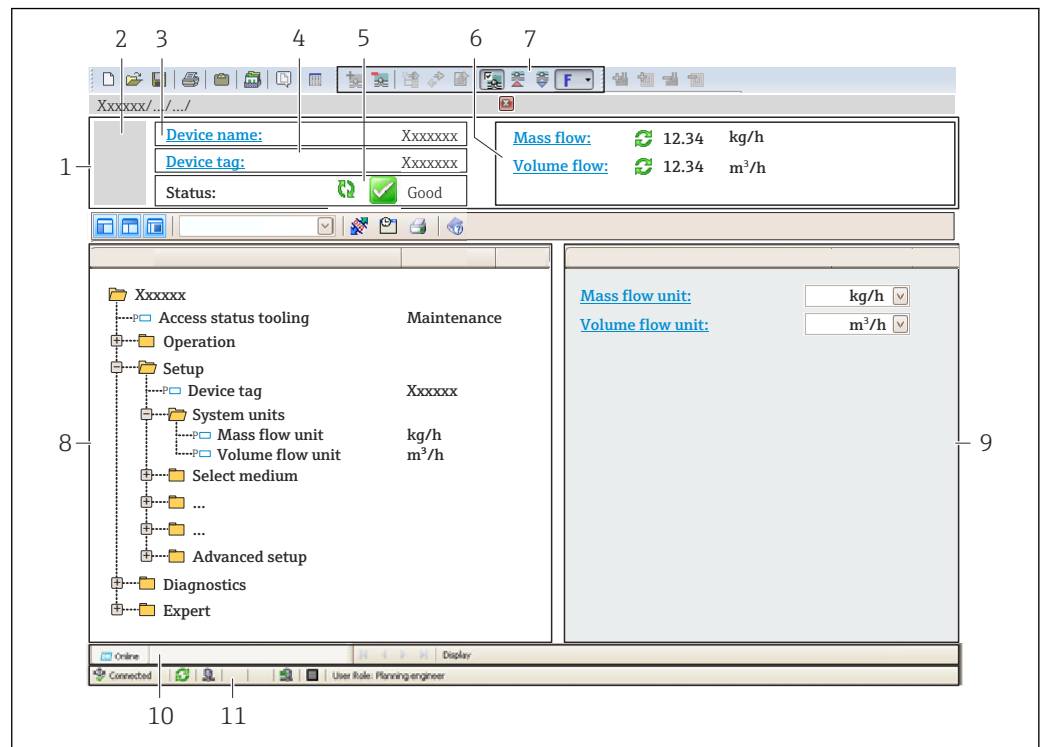

A0021051-EN

- 1 Header
- 2 Picture of device
- 3 Device name
- 4 Device tag
- 5 Status area with status signal → 145
- 6 Display area for current measured values
- 7 Editing toolbar with additional functions such as save/load, event list and create documentation
- 8 Navigation area with operating menu structure
- 9 Work area
- 10 Action area
- 11 Status area

7.5.4 DeviceCare

Function range

Tool for connecting and configuring Endress+Hauser field devices.

The fastest way to configure Endress+Hauser field devices is with the dedicated "DeviceCare" tool. Together with the device type managers (DTMs) it presents a convenient, comprehensive solution.

 Innovation brochure IN01047S

 Source for device description files → 73

7.5.5 AMS Device Manager

Function range

Program from Emerson Process Management for operating and configuring measuring devices via the HART protocol.

 Source for device description files → 73

7.5.6 Field Communicator 475

Function scope

Industrial handheld terminal from Emerson Process Management for remote configuration and measured value display via HART protocol.



Source for device description files

See information →  73

7.5.7 SIMATIC PDM

Function range

SIMATIC PDM is a standardized, manufacturer-independent program from Siemens for the operation, configuration, maintenance and diagnosis of intelligent field devices via HART protocol.

 Source for device description files →  73

8 System integration

8.1 Overview of device description files

8.1.1 Current version data for the device

| | | |
|----------------------------------|----------|---|
| Firmware version | 01.00.zz | <ul style="list-style-type: none"> ▪ On the title page of the Operating Instructions ▪ On the transmitter nameplate → 15 ▪ Firmware version parameter Diagnostics → Device information → Firmware version |
| Release date of firmware version | 07.2020 | --- |
| Manufacturer ID | 0x11 | Manufacturer ID parameter Expert → Communication → HART output → Information → Manufacturer ID |
| Device type ID | 0x1166 | Device type parameter Expert → Communication → HART output → Information → Device type |
| HART protocol revision | 7.0 | --- |
| Device revision | 0x1 | <ul style="list-style-type: none"> ▪ On the transmitter nameplate ▪ Device revision parameter Expert → Communication → HART output → Information → Device revision |

 For an overview of the various firmware versions for the device → 163

8.1.2 Operating tools

The suitable device description file for the individual operating tools is listed in the table below, along with information on where the file can be acquired.

| Operating tool via HART protocol | Sources for obtaining device descriptions |
|--|---|
| FieldCare | <ul style="list-style-type: none"> ▪ www.endress.com → Downloads area ▪ USB stick (contact Endress+Hauser) ▪ DVD (contact Endress+Hauser) |
| DeviceCare | <ul style="list-style-type: none"> ▪ www.endress.com → Downloads area ▪ CD-ROM (contact Endress+Hauser) ▪ DVD (contact Endress+Hauser) |
| <ul style="list-style-type: none"> ▪ Field Xpert SMT70 ▪ Field Xpert SMT77 | Use update function of handheld terminal |
| AMS Device Manager (Emerson Process Management) | www.endress.com → Downloads area |
| SIMATIC PDM (Siemens) | www.endress.com → Downloads area |
| Field Communicator 475 (Emerson Process Management) | Use update function of handheld terminal |

8.2 Measured variables via HART protocol

The following measured variables (HART device variables) are assigned to the dynamic variables at the factory:

| Dynamic variables | Measured variables (HART device variables) |
|----------------------------------|---|
| Primary dynamic variable (PV) | Mass flow |
| Secondary dynamic variable (SV) | Totalizer |
| Tertiary dynamic variable (TV) | Volume flow |
| Quaternary dynamic variable (QV) | Corrected volume flow |

The assignment of the measured variables to the dynamic variables can be modified and assigned as desired via local operation and the operating tool using the following parameters:

- Expert → Communication → HART output → Output → Assign PV
- Expert → Communication → HART output → Output → Assign SV
- Expert → Communication → HART output → Output → Assign TV
- Expert → Communication → HART output → Output → Assign QV

The following measured variables can be assigned to the dynamic variables:

Measured variables for PV (primary dynamic variable)

- Temperature
- Mass flow
- Corrected volume flow
- Energy flow
- Heat flow
- Density
- Flow velocity
- Pressure
- 2nd temperature delta heat
- Electronic temperature

Measured variables for SV, TV, QV (secondary, tertiary and quaternary dynamic variable)

- Mass flow
- Corrected volume flow
- Volume flow
- Temperature
- Density
- Flow velocity
- Pressure
- Energy flow
- Heat flow
- 2nd temperature delta heat
- Electronic temperature
- Totalizer
- HART input

8.2.1 Device variables

Device variables are permanently assigned. A maximum of eight device variables can be transmitted.

| Allocation | Device variables |
|------------|-----------------------|
| 0 | Mass flow |
| 1 | Volume flow |
| 2 | Corrected volume flow |
| 3 | Density |
| 4 | Reference density |

| Allocation | Device variables |
|------------|------------------|
| 5 | Temperature |
| 6 | Totalizer 1 |
| 7 | Totalizer 2 |
| 8 | Totalizer 3 |

8.3 Other settings

Burst mode functionality in accordance with HART 7 Specification:

Navigation

"Expert" menu → Communication → HART output → Burst configuration → Burst configuration 1 to n

▶ Burst configuration 1 to n

| | |
|----------------------|-------|
| Burst mode 1 to n | → 76 |
| Burst command 1 to n | → 76 |
| Burst variable 0 | → 76 |
| Burst variable 1 | → 76 |
| Burst variable 2 | → 76 |
| Burst variable 3 | → 76 |
| Burst variable 4 | → 76 |
| Burst variable 5 | → 76 |
| Burst variable 6 | → 76 |
| Burst variable 7 | → 76 |
| Burst trigger mode | → 76 |
| Burst trigger level | → 76 |
| Min. update period | → 77 |
| Max. update period | → 77 |

Parameter overview with brief description

| Parameter | Description | Selection / User entry |
|----------------------|--|---|
| Burst mode 1 to n | Activate the HART burst mode for burst message X. | <ul style="list-style-type: none"> ■ Off ■ On |
| Burst command 1 to n | Select the HART command that is sent to the HART master. | <ul style="list-style-type: none"> ■ Command 1 ■ Command 2 ■ Command 3 ■ Command 9 ■ Command 33 ■ Command 48 |
| Burst variable 0 | For HART command 9 and 33: select the HART device variable or the process variable. | <ul style="list-style-type: none"> ■ Mass flow ■ Corrected volume flow ■ FAD volume flow * ■ Volume flow ■ Temperature ■ Density ■ Flow velocity ■ Pressure ■ Energy flow * ■ Heat flow * ■ 2nd temperature delta heat * ■ Electronic temperature ■ Totalizer 1 ■ Totalizer 2 ■ Totalizer 3 ■ Percent of range ■ Measured current ■ Current input 1 * ■ Current input 2 * ■ Current input 3 * ■ Primary variable (PV) ■ Secondary variable (SV) ■ Tertiary variable (TV) ■ Quaternary variable (QV) ■ HART input ■ Not used |
| Burst variable 1 | For HART command 9 and 33: select the HART device variable or the process variable. | See the Burst variable 0 parameter. |
| Burst variable 2 | For HART command 9 and 33: select the HART device variable or the process variable. | See the Burst variable 0 parameter. |
| Burst variable 3 | For HART command 9 and 33: select the HART device variable or the process variable. | See the Burst variable 0 parameter. |
| Burst variable 4 | For HART command 9: select the HART device variable or the process variable. | See the Burst variable 0 parameter. |
| Burst variable 5 | For HART command 9: select the HART device variable or the process variable. | See the Burst variable 0 parameter. |
| Burst variable 6 | For HART command 9: select the HART device variable or the process variable. | See the Burst variable 0 parameter. |
| Burst variable 7 | For HART command 9: select the HART device variable or the process variable. | See the Burst variable 0 parameter. |
| Burst trigger mode | Select the event that triggers burst message X. | <ul style="list-style-type: none"> ■ Continuous ■ Window * ■ Rising * ■ Falling * ■ On change |
| Burst trigger level | Enter the burst trigger value. Together with the option selected in the Burst trigger mode parameter the burst trigger value determines the time of burst message X. | Signed floating-point number |

| Parameter | Description | Selection / User entry |
|--------------------|--|------------------------|
| Min. update period | Enter the minimum time span between two burst commands of burst message X. | Positive integer |
| Max. update period | Enter the maximum time span between two burst commands of burst message X. | Positive integer |

* Visibility depends on order options or device settings

9 Commissioning

9.1 Post-mounting and post-connection check

Before commissioning the device:

- ▶ Make sure that the post-installation and post-connection checks have been performed successfully.
- Checklist for "Post-mounting" check → 32
- Checklist for "Post-connection check" → 44

9.2 Switching on the measuring device

- ▶ Switch on the device upon successful completion of the post-mounting and post-connection check.
 - ↳ After a successful startup, the local display switches automatically from the startup display to the operational display.

If nothing appears on the local display or if a diagnostic message is displayed, refer to the section on "Diagnostics and troubleshooting" → 138.

9.3 Setting the operating language

Factory setting: English or ordered local language

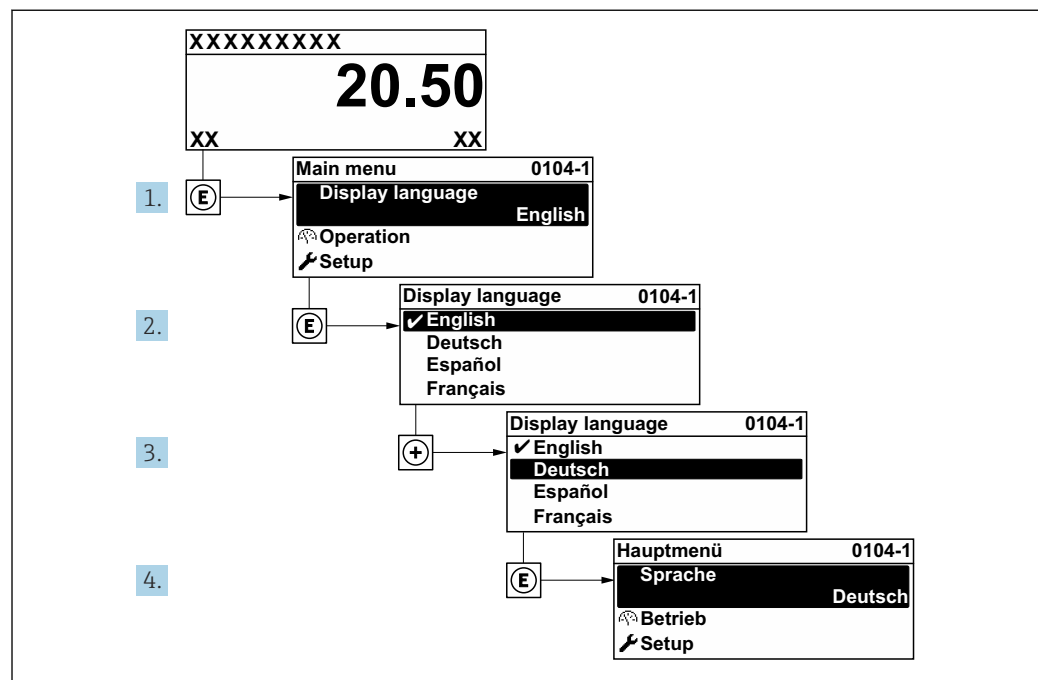

37 Taking the example of the local display

A0029420

9.4 Configuring the measuring device

The **Setup** menu with its guided wizards contains all the parameters needed for standard operation.

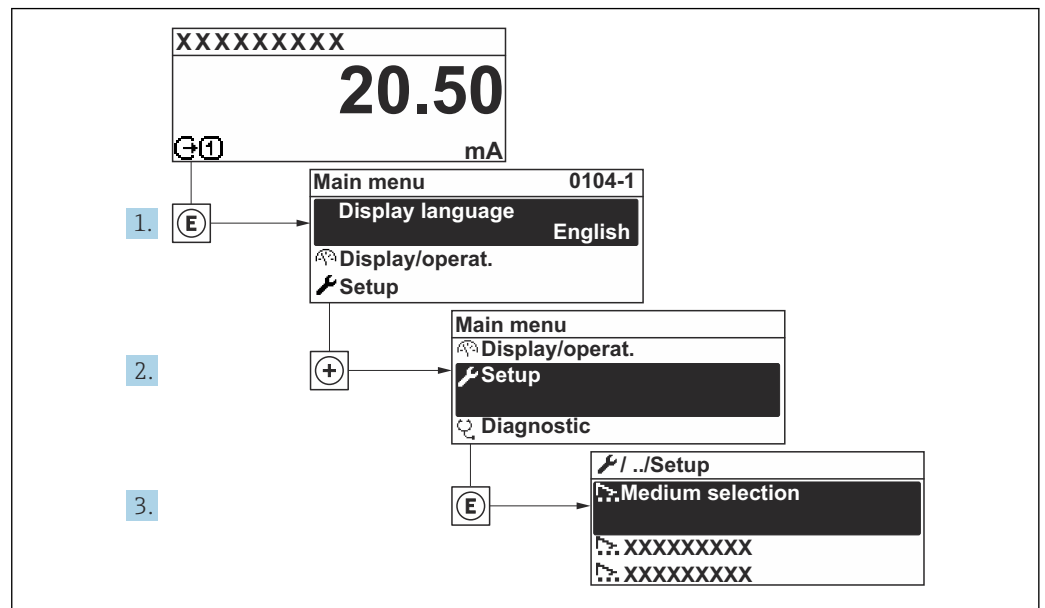

A003222-EN

38 Navigation to "Setup" menu using the example of the local display

i The number of submenus and parameters can vary depending on the device version. Certain submenus and parameters in these submenus are not described in the Operating Instructions. Instead a description is provided in the Special Documentation for the device ("Supplementary documentation").

| 🔧 Setup | |
|--|------|
| Device tag | → 80 |
| ▶ Measurement mode | → 80 |
| ▶ Reference conditions | → 84 |
| ▶ Sensor adjustment | → 85 |
| ▶ System units | → 86 |
| ▶ I/O configuration | → 88 |
| ▶ Current input 1 to n | → 89 |
| ▶ Status input 1 to n | |
| ▶ Current output 1 to n | → 91 |
| ▶ Pulse/frequency/switch output 1 to n | → 94 |

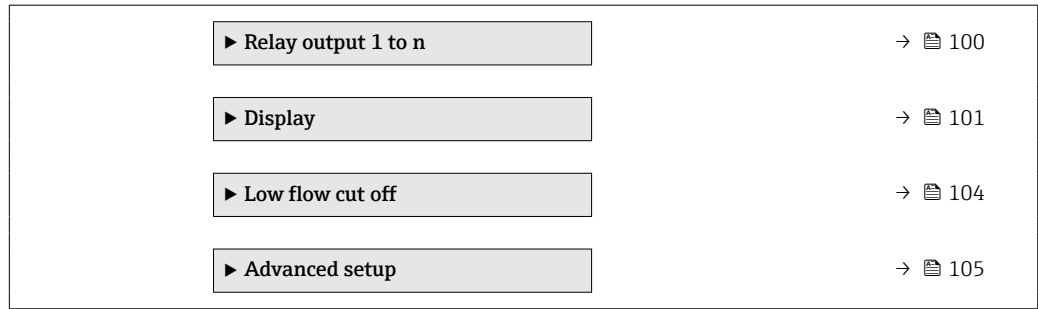

9.4.1 Defining the tag name

To enable fast identification of the measuring point within the system, you can enter a unique designation using the **Device tag** parameter and thus change the factory setting.

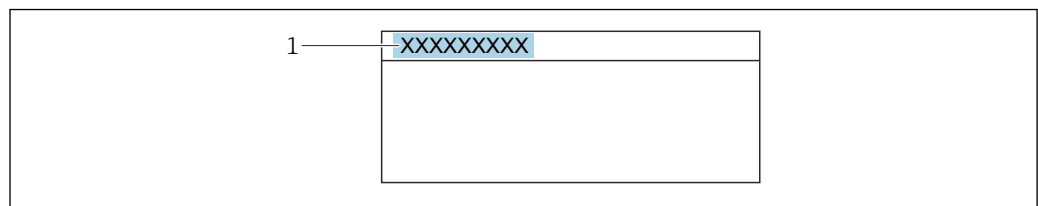

A0029422

39 Header of the operational display with tag name

1 Tag name

i Enter the tag name in the "FieldCare" operating tool → 71

Navigation

"Setup" menu → Device tag

Parameter overview with brief description

| Parameter | Description | User entry |
|------------|---|--|
| Device tag | Enter the name for the measuring point. | Max. 32 characters, such as letters, numbers or special characters (e.g. @, %, /). |

9.4.2 Configuring the measurement mode

Properties of the medium can be configured in the **Measurement mode** submenu.

Navigation

"Setup" menu → Measurement mode

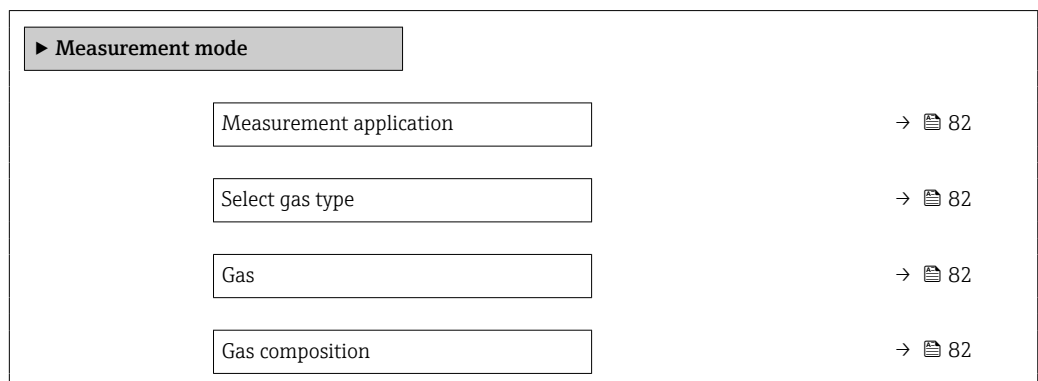

| | |
|------------------|------|
| Mol% Air | → 82 |
| Mol% Ar | → 83 |
| Mol% C2H4 | → 83 |
| Mol% C2H6 | → 83 |
| Mol% C3H8 | → 83 |
| Mol% CH4 | → 83 |
| Mol% Cl2 | → 83 |
| Mol% CO | → 83 |
| Mol% CO2 | → 83 |
| Mol% H2 | → 83 |
| Mol% H2O | → 83 |
| Mol% H2S | → 83 |
| Mol% HCl | → 83 |
| Mol% He | → 83 |
| Mol% Kr | → 83 |
| Mol% N2 | → 83 |
| Mol% n-C4H10 | → 83 |
| Mol% Ne | → 84 |
| Mol% NH3 | → 84 |
| Mol% O2 | → 84 |
| Mol% O3 | → 84 |
| Mol% Xe | → 84 |
| Special gas name | → 84 |

Parameter overview with brief description

| Parameter | Prerequisite | Description | Selection / User entry / User interface | Factory setting |
|-------------------------|--|---|---|-----------------|
| Measurement application | – | Select measurement application. | <ul style="list-style-type: none"> ▪ Air or compressed air ▪ Gas or gas mixture ▪ Energy | – |
| Select gas type | – | Select measured gas type. | <ul style="list-style-type: none"> ▪ Single gas ▪ Gas mixture ▪ Special gas * | – |
| Gas | The Single gas option is selected in the Select gas type parameter parameter. | Select measured gas. | <ul style="list-style-type: none"> ▪ Air ▪ Ammonia NH₃ ▪ Argon Ar ▪ Butane C₄H₁₀ ▪ Carbon dioxide CO₂ ▪ Carbon monoxide CO ▪ Chlorine Cl₂ ▪ Ethane C₂H₆ ▪ Ethylene C₂H₄ ▪ Helium He ▪ Hydrogen H₂ ▪ Hydrogen chloride HCl ▪ Hydrogen sulfide H₂S ▪ Krypton Kr ▪ Methane CH₄ ▪ Neon Ne ▪ Nitrogen N₂ ▪ Oxygen O₂ ▪ Ozone O₃ ▪ Propane C₃H₈ ▪ Xenon Xe | – |
| Gas composition | The Gas mixture option is selected in the Select gas type parameter parameter. | Select measured gas mixture. | <ul style="list-style-type: none"> ▪ Air ▪ Hydrogen H₂ ▪ Helium He ▪ Neon Ne ▪ Argon Ar ▪ Krypton Kr ▪ Xenon Xe ▪ Nitrogen N₂ ▪ Oxygen O₂ ▪ Chlorine Cl₂ ▪ Ammonia NH₃ ▪ Carbon monoxide CO ▪ Carbon dioxide CO₂ ▪ Hydrogen sulfide H₂S ▪ Hydrogen chloride HCl ▪ Methane CH₄ ▪ Propane C₃H₈ ▪ Ethane C₂H₆ ▪ Butane C₄H₁₀ ▪ Ethylene C₂H₄ ▪ Water ▪ Ozone O₃ | – |
| Mol% Air | – | Enter amount of substance for the gas mixture. Air | 0 to 100 % | – |

| Parameter | Prerequisite | Description | Selection / User entry / User interface | Factory setting |
|--------------|--------------|---|---|-----------------|
| Mol% Ar | – | Enter amount of substance for the gas mixture. Ar = Argon | 0 to 100 % | – |
| Mol% C2H4 | – | Enter amount of substance for the gas mixture. C ₂ H ₄ = ethylene | 0 to 100 % | – |
| Mol% C2H6 | – | Enter amount of substance for the gas mixture. C ₂ H ₆ = ethane | 0 to 100 % | – |
| Mol% C3H8 | – | Enter amount of substance for the gas mixture. C ₃ H ₈ = propane | 0 to 100 % | – |
| Mol% CH4 | – | Enter amount of substance for the gas mixture. CH ₄ = methane | 0 to 100 % | – |
| Mol% Cl2 | – | Enter amount of substance for the gas mixture. Cl ₂ = chlorine | 0 to 100 % | – |
| Mol% CO | – | Enter amount of substance for the gas mixture. CO = carbon monoxide | 0 to 100 % | – |
| Mol% CO2 | – | Enter amount of substance for the gas mixture. CO ₂ = carbon dioxide | 0 to 100 % | – |
| Mol% H2 | – | Enter amount of substance for the gas mixture. H ₂ = hydrogen | 0 to 100 % | – |
| Mol% H2O | – | Enter amount of substance for the gas mixture. H ₂ O = water | 0 to 20 % | – |
| Mol% H2S | – | Enter amount of substance for the gas mixture. H ₂ S = hydrogen sulfide | 0 to 100 % | – |
| Mol% HCl | – | Enter amount of substance for the gas mixture. HCl = hydrogen chloride | 0 to 100 % | – |
| Mol% He | – | Enter amount of substance for the gas mixture. He = helium | 0 to 100 % | – |
| Mol% Kr | – | Enter amount of substance for the gas mixture. Kr = krypton | 0 to 100 % | – |
| Mol% N2 | – | Enter amount of substance for the gas mixture. N ₂ = nitrogen | 0 to 100 % | – |
| Mol% n-C4H10 | – | Enter amount of substance for the gas mixture. n-C ₄ H ₁₀ = n-butane | 0 to 100 % | – |

| Parameter | Prerequisite | Description | Selection / User entry / User interface | Factory setting |
|----------------------|--|---|---|-----------------|
| Mol% Ne | - | Enter amount of substance for the gas mixture. Ne = neon | 0 to 100 % | - |
| Mol% NH ₃ | - | Enter amount of substance for the gas mixture. NH ₃ = ammonia | 0 to 100 % | - |
| Mol% O ₂ | - | Enter amount of substance for the gas mixture. O ₂ = oxygen | 0 to 100 % | - |
| Mol% O ₃ | As a mixture, only possible with O ₂ : <ul style="list-style-type: none"> ■ O₃: 0 to 35 % ■ O₂: 65 to 100 % O ₃ as single gas: 100 % | Enter amount of substance for the gas mixture. | 0 to 100 % | - |
| Mol% Xe | - | Enter amount of substance for the gas mixture. Xe = xenon | 0 to 100 % | - |
| Special gas name | Special gas option application package is available. | Shows the description of the gas ordered by the customer, e.g. gas name or gas composition. | - | - |

* Visibility depends on order options or device settings

9.4.3 Configuring reference conditions

Reference properties can be configured in the **Reference conditions** submenu.

Navigation

"Setup" menu → Reference conditions

| ► Reference conditions | |
|----------------------------------|------|
| Reference conditions | → 85 |
| Reference pressure | → 85 |
| Reference temperature | → 85 |
| FAD conditions | → 85 |
| FAD pressure | → 85 |
| FAD temperature | → 85 |
| Reference combustion temperature | → 85 |
| Reference combustion temperature | → 85 |



Parameter overview with brief description





| Parameter | Prerequisite | Description | Selection / User entry |
|----------------------------------|--|---|--|
| Reference conditions | – | Select reference conditions for calculation of the corrected volume flow. | <ul style="list-style-type: none"> ■ 1013.25 mbara, 0 °C ■ 1013.25 mbara, 15 °C ■ 1013.25 mbara, 20 °C ■ 1013.25 mbara, 25 °C ■ 1000 mbara, 0 °C ■ 1000 mbara, 15 °C ■ 1000 mbara, 20 °C ■ 1000 mbara, 25 °C ■ 14.696 psia, 59 °F ■ 14.696 psia, 60 °F ■ User-defined |
| Reference pressure | The Others option is selected in the Reference conditions parameter. | Select reference conditions for the corrected volume flow. | 0 to 250 bar a |
| Reference temperature | – | Enter reference temperature for calculating the reference density. | –200 to 450 °C |
| FAD conditions | The Air or compressed air option is selected in the Measurement application parameter parameter. | Select reference conditions for the calculation of the FAD density (FAD = free air delivery). | <ul style="list-style-type: none"> ■ 1000 mbara, 20 °C ■ 14.504 psia, 68 °F ■ User-defined |
| FAD pressure | <ul style="list-style-type: none"> ■ The Air or compressed air option is selected in the Measurement application parameter parameter. ■ The User-defined option is selected in the FAD conditions parameter parameter. | Enter reference pressure for the calculation of the FAD density (FAD = free air delivery). | 0 to 250 bar a |
| FAD temperature | <ul style="list-style-type: none"> ■ The Air or compressed air option is selected in the Measurement application parameter parameter. ■ The User-defined option is selected in the FAD conditions parameter parameter. | Enter reference temperature for the calculation of the FAD density (FAD = free air delivery). | –200 to 450 °C |
| Reference combustion temperature | The Energy option is selected in the Measurement application parameter parameter. | Enter reference combustion temperature to calculate the natural gas energy value. | –200 to 450 °C |
| Reference combustion temperature | – | Select ref. temp. (reference combustion temperature) for calculating the gas energy value. | <ul style="list-style-type: none"> ■ 0 °C ■ 15 °C ■ 20 °C ■ 25 °C ■ 60 °F ■ User-defined |

9.4.4 Sensor adjustment

Parameters pertaining to the pipe shape of the insertion version can be configured in the **Sensor adjustment** submenu.

 The number of submenus and parameters can vary depending on the device version. Certain submenus and parameters in these submenus are not described in the Operating Instructions. Instead a description is provided in the Special Documentation for the device ("Supplementary documentation").

| | |
|----------------------------|--|
| ► Sensor adjustment | |
| Installation direction | →  86 |
| Installation factor | →  86 |

| | |
|---------------------|--|
| Pipe shape | →  86 |
| Pipe inner diameter | →  86 |
| Duct height | →  86 |
| Duct width | →  86 |

Parameter overview with brief description

| Parameter | Prerequisite | Description | Selection / User entry |
|------------------------|-------------------------------|---|---|
| Installation direction | - | Set sign of flow direction to match the direction of the arrow on the sensor. | <ul style="list-style-type: none"> ■ Flow in arrow direction ■ Flow against arrow direction |
| Installation factor | - | Enter factor to compensate the mounting-related measurement error. | 0.01 to 100.0 |
| Pipe shape | Only available with t-mass I. | Select the shape of the pipe. | <ul style="list-style-type: none"> ■ Circular ■ Rectangular |
| Pipe inner diameter | Only available with t-mass I. | Enter the internal diameter of a circular pipe. | 0.050 to 5 m |
| Duct height | Only available with t-mass I. | Enter inner duct height. Duct height and sensor shaft are parallel. | 0.050 to 5 m |
| Duct width | Only available with t-mass I. | Enter inner duct width. The duct width is vertical to the sensor shaft. | 0.050 to 5 m |







9.4.5 Setting the system units









In the **System units** submenu the units of all the measured values can be set.

 The number of submenus and parameters can vary depending on the device version. Certain submenus and parameters in these submenus are not described in the Operating Instructions. Instead a description is provided in the Special Documentation for the device ("Supplementary documentation").

Navigation

"Setup" menu → System units

| | |
|----------------------------|--|
| ▶ System units | |
| Mass flow unit | →  87 |
| Mass unit | →  87 |
| Corrected volume flow unit | →  87 |
| Corrected volume unit | →  87 |
| Volume flow unit | →  87 |
| Volume unit | →  87 |

| | |
|----------------------|--|
| FAD volume flow unit | →  87 |
| FAD volume unit | →  87 |
| Energy flow unit | →  87 |
| Energy unit | →  88 |
| Calorific value unit | →  88 |
| Density unit | →  88 |
| Temperature unit | →  88 |
| Pressure unit | →  88 |
| Velocity unit | →  88 |
| Length unit | →  88 |
| Date/time format | →  88 |

Parameter overview with brief description

| Parameter | Description | Selection | Factory setting |
|----------------------------|---|------------------|--|
| Mass flow unit | Select mass flow unit. | Unit choose list | Depends on country: <ul style="list-style-type: none"> ■ kg/h ■ lb/h |
| Mass unit | Select mass unit. | Unit choose list | Country-specific: <ul style="list-style-type: none"> ■ kg ■ lb |
| Corrected volume flow unit | Select corrected volume flow unit. | Unit choose list | Country-specific: <ul style="list-style-type: none"> ■ Nm³/h ■ Sft³/h |
| Corrected volume unit | Select corrected volume unit. | Unit choose list | Country-specific: <ul style="list-style-type: none"> ■ Nm³ ■ Sft³ |
| Volume flow unit | Select volume flow unit. | Unit choose list | Depends on country: <ul style="list-style-type: none"> ■ l/h ■ ft³/h |
| Volume unit | Select volume unit. | Unit choose list | Country-specific: <ul style="list-style-type: none"> ■ ft³ ■ m³ |
| FAD volume flow unit | Select FAD volumen flow unit (FAD = free air delivery). | Unit choose list | Country-specific: <ul style="list-style-type: none"> ■ m³ FAD/h ■ cf FAD/min |
| FAD volume unit | Select FAD volumen unit (FAD = free air delivery). | Unit choose list | Country-specific: <ul style="list-style-type: none"> ■ m³ FAD ■ cf FAD |
| Energy flow unit | Select energy flow unit. | Unit choose list | Country-specific: <ul style="list-style-type: none"> ■ kW ■ Btu/h |

| Parameter | Description | Selection | Factory setting |
|----------------------|--|--|--|
| Energy unit | Select energy unit. | Unit choose list | Country-specific: <ul style="list-style-type: none"> ▪ kWh ▪ Btu |
| Calorific value unit | Select calorific value unit. | Unit choose list | Country-specific: <ul style="list-style-type: none"> ▪ kWh/Nm³ ▪ Btu/Sft³ |
| Density unit | Select density unit. | Unit choose list | Country-specific: <ul style="list-style-type: none"> ▪ kg/m³ ▪ lb/ft³ |
| Temperature unit | Select temperature unit. | Unit choose list | Country-specific: <ul style="list-style-type: none"> ▪ °C ▪ °F |
| Pressure unit | Select process pressure unit. | Unit choose list | Country-specific: <ul style="list-style-type: none"> ▪ bar a ▪ psi a |
| Velocity unit | Select velocity unit. | Unit choose list | Country-specific: <ul style="list-style-type: none"> ▪ m/s ▪ ft/s |
| Length unit | Select length unit for nominal diameter. | Unit choose list | Country-specific: <ul style="list-style-type: none"> ▪ mm ▪ in |
| Date/time format | Select date and time format. | <ul style="list-style-type: none"> ▪ dd.mm.yy hh:mm ▪ dd.mm.yy hh:mm am/pm ▪ mm/dd/yy hh:mm ▪ mm/dd/yy hh:mm am/pm | – |

9.4.6 Displaying the I/O configuration

The **I/O configuration** submenu guides the user systematically through all the parameters in which the configuration of the I/O modules is displayed.

Navigation

"Setup" menu → I/O configuration

| ► I/O configuration | |
|------------------------------------|------|
| I/O module 1 to n terminal numbers | → 89 |
| I/O module 1 to n information | → 89 |
| I/O module 1 to n type | → 89 |
| Apply I/O configuration | → 89 |
| I/O alteration code | → 89 |

Parameter overview with brief description

| Parameter | Description | User interface / Selection / User entry |
|------------------------------------|---|---|
| I/O module 1 to n terminal numbers | Shows the terminal numbers used by the I/O module. | <ul style="list-style-type: none"> ■ Not used ■ 26-27 (I/O 1) ■ 24-25 (I/O 2) ■ 22-23 (I/O 3) |
| I/O module 1 to n information | Shows information of the plugged I/O module. | <ul style="list-style-type: none"> ■ Not plugged ■ Invalid ■ Not configurable ■ Configurable ■ HART |
| I/O module 1 to n type | Shows the I/O module type. | <ul style="list-style-type: none"> ■ Off ■ Current output * ■ Current input * ■ Status input * ■ Pulse/frequency/switch output * ■ Relay output * |
| Apply I/O configuration | Apply parameterization of the freely configurable I/O module. | <ul style="list-style-type: none"> ■ No ■ Yes |
| I/O alteration code | Enter the code in order to change the I/O configuration. | Positive integer |

* Visibility depends on order options or device settings

9.4.7 Configuring the current input

The "Current input" wizard guides the user systematically through all the parameters that have to be set for configuring the current input.

Navigation

"Setup" menu → Current input

▶ **Current input 1 to n**

| | |
|-----------------|--------|
| Current span | → ⓘ 90 |
| Terminal number | → ⓘ 90 |
| Signal mode | → ⓘ 90 |
| Terminal number | → ⓘ 90 |
| 0/4 mA value | → ⓘ 90 |
| 20 mA value | → ⓘ 90 |
| Failure mode | → ⓘ 90 |
| Terminal number | → ⓘ 90 |
| Failure value | → ⓘ 90 |
| Terminal number | → ⓘ 90 |

Parameter overview with brief description

| Parameter | Prerequisite | Description | Selection / User interface / User entry | Factory setting |
|-----------------|---|---|---|---|
| Current span | – | Select current range for process value output and upper/lower level for alarm signal. | <ul style="list-style-type: none"> ▪ 4...20 mA (4...20.5 mA) ▪ 4...20 mA NAMUR (3.8...20.5 mA) ▪ 4...20 mA US (3.9...20.8 mA) ▪ 0...20 mA (0...20.5 mA) | Country-specific: <ul style="list-style-type: none"> ▪ 4...20 mA NAMUR (3.8...20.5 mA) ▪ 4...20 mA US (3.9...20.8 mA) |
| Terminal number | – | Shows the terminal numbers used by the current input module. | <ul style="list-style-type: none"> ▪ Not used ▪ 24-25 (I/O 2) ▪ 22-23 (I/O 3) | – |
| Signal mode | The measuring device is not approved for use in the hazardous area with type of protection Ex-i. | Select the signal mode for the current input. | <ul style="list-style-type: none"> ▪ Passive ▪ Active* | Active |
| 0/4 mA value | – | Enter 4 mA value. | Signed floating-point number | – |
| 20 mA value | – | Enter 20 mA value. | Signed floating-point number | Depends on country and nominal diameter |
| Failure mode | – | Define input behavior in alarm condition. | <ul style="list-style-type: none"> ▪ Alarm ▪ Last valid value ▪ Defined value | – |
| Failure value | In the Failure mode parameter, the Defined value option is selected. | Enter value to be used by the device if input value from external device is missing. | Signed floating-point number | – |

* Visibility depends on order options or device settings

9.4.8 Configuring the status input

The **Status input** submenu guides the user systematically through all the parameters that have to be set for configuring the status input.

Navigation

"Setup" menu → Status input 1 to n

| ► Status input 1 to n | |
|----------------------------|------|
| Assign status input | → 91 |
| Terminal number | → 91 |
| Active level | → 91 |
| Terminal number | → 91 |
| Response time status input | → 91 |
| Terminal number | → 91 |

Parameter overview with brief description

| Parameter | Description | Selection / User interface / User entry |
|----------------------------|---|---|
| Assign status input | Select function for the status input. | <ul style="list-style-type: none"> ■ Off ■ Reset totalizer 1 ■ Reset totalizer 2 ■ Reset totalizer 3 ■ Reset all totalizers ■ Flow override ■ Gas group * ■ Zero point adjustment |
| Terminal number | Shows the terminal numbers used by the status input module. | <ul style="list-style-type: none"> ■ Not used ■ 24-25 (I/O 2) ■ 22-23 (I/O 3) |
| Active level | Define input signal level at which the assigned function is triggered. | <ul style="list-style-type: none"> ■ High ■ Low |
| Response time status input | Define the minimum amount of time the input signal level must be present before the selected function is triggered. | 5 to 200 ms |

* Visibility depends on order options or device settings

9.4.9 Configuring the current output

The **Current output** wizard guides you systematically through all the parameters that have to be set for configuring the current output.

Navigation

"Setup" menu → Current output

▶ **Current output 1 to n**

| | |
|------------------------------|--------|
| Assign current output 1 to n | → ⓘ 92 |
| Terminal number | → ⓘ 92 |
| Current span | → ⓘ 92 |
| Terminal number | → ⓘ 92 |
| Signal mode | → ⓘ 92 |
| Terminal number | → ⓘ 92 |
| 0/4 mA value | → ⓘ 92 |
| 20 mA value | → ⓘ 93 |
| Fixed current | → ⓘ 93 |
| Terminal number | → ⓘ 92 |
| Damping output 1 to n | → ⓘ 93 |

| | |
|-----------------|------|
| Failure mode | → 93 |
| Terminal number | → 92 |
| Failure current | → 93 |
| Terminal number | → 92 |

Parameter overview with brief description

| Parameter | Prerequisite | Description | Selection / User interface / User entry | Factory setting |
|------------------------------|---|---|--|---|
| Assign current output 1 to n | – | Select process variable for current output. | <ul style="list-style-type: none"> ▪ Off * ▪ Temperature ▪ Mass flow ▪ Corrected volume flow ▪ FAD volume flow * ▪ Volume flow ▪ Energy flow * ▪ Heat flow * ▪ Density ▪ Flow velocity ▪ Pressure ▪ 2nd temperature delta heat * ▪ Electronic temperature | – |
| Terminal number | – | Shows the terminal numbers used by the current output module. | <ul style="list-style-type: none"> ▪ Not used ▪ 26-27 (I/O 1) ▪ 24-25 (I/O 2) ▪ 22-23 (I/O 3) | – |
| Current span | – | Select current range for process value output and upper/lower level for alarm signal. | <ul style="list-style-type: none"> ▪ 4...20 mA NAMUR (3.8...20.5 mA) ▪ 4...20 mA US (3.9...20.8 mA) ▪ 4...20 mA (4... 20.5 mA) ▪ 0...20 mA (0... 20.5 mA) ▪ Fixed current | Depends on country: <ul style="list-style-type: none"> ▪ 4...20 mA NAMUR (3.8...20.5 mA) ▪ 4...20 mA US (3.9...20.8 mA) |
| Signal mode | – | Select the signal mode for the current output. | <ul style="list-style-type: none"> ▪ Active * ▪ Passive * | Active |
| 0/4 mA value | One of the following options is selected in the Current span parameter (→ 92): <ul style="list-style-type: none"> ▪ 4...20 mA NAMUR (3.8...20.5 mA) ▪ 4...20 mA US (3.9...20.8 mA) ▪ 4...20 mA (4... 20.5 mA) ▪ 0...20 mA (0... 20.5 mA) | Enter 4 mA value. | Signed floating-point number | – |

| Parameter | Prerequisite | Description | Selection / User interface / User entry | Factory setting |
|-----------------------|---|--|---|---|
| 20 mA value | One of the following options is selected in the Current span parameter (→ 92): <ul style="list-style-type: none"> ▪ 4...20 mA NAMUR (3.8...20.5 mA) ▪ 4...20 mA US (3.9...20.8 mA) ▪ 4...20 mA (4... 20.5 mA) ▪ 0...20 mA (0... 20.5 mA) | Enter 20 mA value. | Signed floating-point number | Depends on country and nominal diameter |
| Fixed current | The Fixed current option is selected in the Current span parameter (→ 92). | Defines the fixed output current. | 0 to 22.5 mA | 22.5 mA |
| Damping output 1 to n | A process variable is selected in the Assign current output parameter (→ 92) and one of the following options is selected in the Current span parameter (→ 92): <ul style="list-style-type: none"> ▪ 4...20 mA NAMUR (3.8...20.5 mA) ▪ 4...20 mA US (3.9...20.8 mA) ▪ 4...20 mA (4... 20.5 mA) ▪ 0...20 mA (0... 20.5 mA) | Set reaction time for output signal to fluctuations in the measured value. | 0.0 to 999.9 s | – |
| Failure mode | A process variable is selected in the Assign current output parameter (→ 92) and one of the following options is selected in the Current span parameter (→ 92): <ul style="list-style-type: none"> ▪ 4...20 mA NAMUR (3.8...20.5 mA) ▪ 4...20 mA US (3.9...20.8 mA) ▪ 4...20 mA (4... 20.5 mA) ▪ 0...20 mA (0... 20.5 mA) | Define output behavior in alarm condition. | <ul style="list-style-type: none"> ▪ Min. ▪ Max. ▪ Last valid value ▪ Actual value ▪ Defined value | – |
| Failure current | The Defined value option is selected in the Failure mode parameter. | Enter current output value in alarm condition. | 0 to 22.5 mA | 22.5 mA |

* Visibility depends on order options or device settings

9.4.10 Configuring the pulse/frequency/switch output

The **Pulse/frequency/switch output** wizard guides you systematically through all the parameters that can be set for configuring the selected output type.

Navigation

"Setup" menu → Advanced setup → Pulse/frequency/switch output

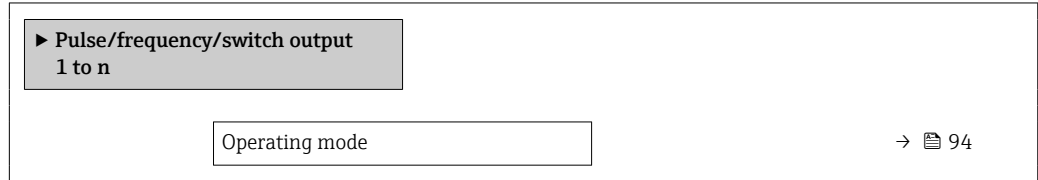

Parameter overview with brief description

| Parameter | Description | Selection |
|----------------|---|--|
| Operating mode | Define the output as a pulse, frequency or switch output. | <ul style="list-style-type: none"> ■ Pulse ■ Frequency ■ Switch |

Configuring the pulse output

Navigation

"Setup" menu → Pulse/frequency/switch output

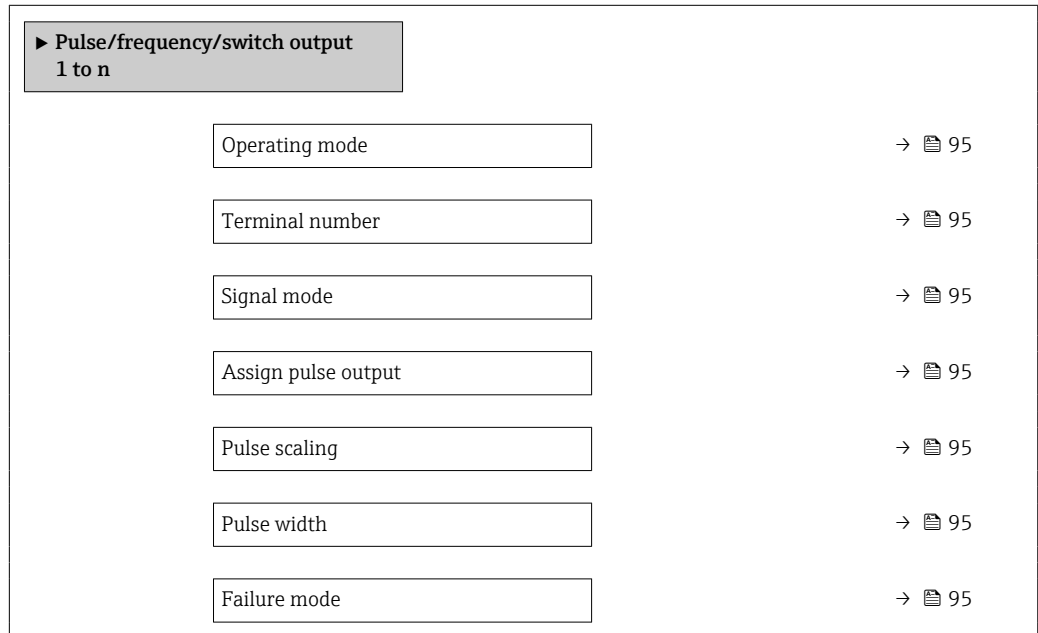

Parameter overview with brief description

| Parameter | Prerequisite | Description | Selection / User interface / User entry | Factory setting |
|----------------------------|--|---|---|---|
| Operating mode | – | Define the output as a pulse, frequency or switch output. | <ul style="list-style-type: none"> ■ Pulse ■ Frequency ■ Switch | – |
| Terminal number | – | Shows the terminal numbers used by the PFS output module. | <ul style="list-style-type: none"> ■ Not used ■ 24-25 (I/O 2) ■ 22-23 (I/O 3) | – |
| Signal mode | – | Select the signal mode for the PFS output. | <ul style="list-style-type: none"> ■ Passive ■ Active * ■ Passive NAMUR | – |
| Assign pulse output 1 to n | The Pulse option is selected in the Operating mode parameter. | Select process variable for pulse output. | <ul style="list-style-type: none"> ■ Off ■ Mass flow ■ Corrected volume flow ■ FAD volume flow * ■ Volume flow ■ Energy flow * ■ Heat flow * | – |
| Pulse scaling | The Pulse option is selected in the Operating mode parameter (→ 94) and a process variable is selected in the Assign pulse output parameter (→ 95). | Enter quantity for measured value at which a pulse is output. | Positive floating point number | Depends on country and nominal diameter |
| Pulse width | The Pulse option is selected in the Operating mode parameter (→ 94) and a process variable is selected in the Assign pulse output parameter (→ 95). | Define time width of the output pulse. | 0.05 to 2 000 ms | – |
| Failure mode | The Pulse option is selected in the Operating mode parameter (→ 94) and a process variable is selected in the Assign pulse output parameter (→ 95). | Define output behavior in alarm condition. | <ul style="list-style-type: none"> ■ Actual value ■ No pulses | – |

* Visibility depends on order options or device settings

Configuring the frequency output

Navigation

"Setup" menu → Pulse/frequency/switch output

▶ **Pulse/frequency/switch output 1 to n**

| | |
|-------------------------|------|
| Operating mode | → 96 |
| Terminal number | → 96 |
| Signal mode | → 96 |
| Assign frequency output | → 96 |

| | |
|--------------------------------------|------|
| Minimum frequency value | → 96 |
| Maximum frequency value | → 97 |
| Measuring value at minimum frequency | → 97 |
| Measuring value at maximum frequency | → 97 |
| Failure mode | → 97 |
| Failure frequency | → 97 |
| Invert output signal | → 97 |

Parameter overview with brief description

| Parameter | Prerequisite | Description | Selection / User interface / User entry | Factory setting |
|-------------------------|--|---|---|-----------------|
| Operating mode | – | Define the output as a pulse, frequency or switch output. | <ul style="list-style-type: none"> ▪ Pulse ▪ Frequency ▪ Switch | – |
| Terminal number | – | Shows the terminal numbers used by the PFS output module. | <ul style="list-style-type: none"> ▪ Not used ▪ 24-25 (I/O 2) ▪ 22-23 (I/O 3) | – |
| Signal mode | – | Select the signal mode for the PFS output. | <ul style="list-style-type: none"> ▪ Passive ▪ Active* ▪ Passive NAMUR | – |
| Assign frequency output | In the Operating mode parameter (→ 94), the Frequency option is selected. | Select process variable for frequency output. | <ul style="list-style-type: none"> ▪ Off ▪ Temperature ▪ Mass flow ▪ Corrected volume flow ▪ FAD volume flow* ▪ Volume flow* ▪ Energy flow* ▪ Heat flow* ▪ Density ▪ Flow velocity ▪ Pressure ▪ 2nd temperature delta heat* ▪ Electronic temperature | – |
| Minimum frequency value | The Frequency option is selected in the Operating mode parameter (→ 94) and a process variable is selected in the Assign frequency output parameter (→ 96). | Enter minimum frequency. | 0.0 to 10 000.0 Hz | – |

| Parameter | Prerequisite | Description | Selection / User interface / User entry | Factory setting |
|--------------------------------------|---|--|---|---|
| Maximum frequency value | The Frequency option is selected in the Operating mode parameter (→ 94) and a process variable is selected in the Assign frequency output parameter (→ 96). | Enter maximum frequency. | 0.0 to 10000.0 Hz | – |
| Measuring value at minimum frequency | The Frequency option is selected in the Operating mode parameter (→ 94) and a process variable is selected in the Assign frequency output parameter (→ 96). | Enter measured value for minimum frequency. | Signed floating-point number | Depends on country and nominal diameter |
| Measuring value at maximum frequency | The Frequency option is selected in the Operating mode parameter (→ 94) and a process variable is selected in the Assign frequency output parameter (→ 96). | Enter measured value for maximum frequency. | Signed floating-point number | Depends on country and nominal diameter |
| Failure mode | The Frequency option is selected in the Operating mode parameter (→ 94) and a process variable is selected in the Assign frequency output parameter (→ 96). | Define output behavior in alarm condition. | <ul style="list-style-type: none"> ■ Actual value ■ Defined value ■ 0 Hz | – |
| Failure frequency | In the Operating mode parameter (→ 94), the Frequency option is selected, in the Assign frequency output parameter (→ 96) a process variable is selected, and in the Failure mode parameter, the Defined value option is selected. | Enter frequency output value in alarm condition. | 0.0 to 12500.0 Hz | – |
| Invert output signal | – | Invert the output signal. | <ul style="list-style-type: none"> ■ No ■ Yes | – |

* Visibility depends on order options or device settings

Configuring the switch output

Navigation

"Setup" menu → Pulse/frequency/switch output

| ► Pulse/frequency/switch output 1 to n | |
|---|-------|
| Operating mode | → 98 |
| Terminal number | → 98 |
| Signal mode | → 98 |
| Switch output function | → 99 |
| Assign diagnostic behavior | → 99 |
| Assign limit | → 99 |
| Assign status | → 99 |
| Switch-on value | → 99 |
| Switch-off value | → 99 |
| Switch-on delay | → 99 |
| Switch-off delay | → 100 |
| Failure mode | → 100 |

Parameter overview with brief description

| Parameter | Prerequisite | Description | Selection / User interface / User entry | Factory setting |
|-----------------|--------------|---|--|-----------------|
| Operating mode | – | Define the output as a pulse, frequency or switch output. | <ul style="list-style-type: none"> ▪ Pulse ▪ Frequency ▪ Switch | – |
| Terminal number | – | Shows the terminal numbers used by the PFS output module. | <ul style="list-style-type: none"> ▪ Not used ▪ 24-25 (I/O 2) ▪ 22-23 (I/O 3) | – |
| Signal mode | – | Select the signal mode for the PFS output. | <ul style="list-style-type: none"> ▪ Passive ▪ Active * ▪ Passive NAMUR | – |

| Parameter | Prerequisite | Description | Selection / User interface / User entry | Factory setting |
|----------------------------|---|--|--|---|
| Switch output function | The Switch option is selected in the Operating mode parameter. | Select function for switch output. | <ul style="list-style-type: none"> ■ Off ■ On ■ Diagnostic behavior ■ Limit ■ Flow direction check * ■ Status | – |
| Assign diagnostic behavior | <ul style="list-style-type: none"> ■ In the Operating mode parameter, the Switch option is selected. ■ In the Switch output function parameter, the Diagnostic behavior option is selected. | Select diagnostic behavior for switch output. | <ul style="list-style-type: none"> ■ Alarm ■ Alarm or warning ■ Warning | – |
| Assign limit | <ul style="list-style-type: none"> ■ The Switch option is selected in the Operating mode parameter. ■ The Limit option is selected in the Switch output function parameter. | Select process variable for limit function. | <ul style="list-style-type: none"> ■ Temperature ■ Mass flow ■ Corrected volume flow ■ FAD volume flow * ■ Volume flow ■ Energy flow * ■ Heat flow * ■ Density ■ Flow velocity ■ 2nd temperature delta heat * ■ Electronic temperature ■ Totalizer 1 ■ Totalizer 2 ■ Totalizer 3 | – |
| Assign status | <ul style="list-style-type: none"> ■ The Switch option is selected in the Operating mode parameter. ■ The Status option is selected in the Switch output function parameter. | Select device status for switch output. | <ul style="list-style-type: none"> ■ Off ■ Low flow cut off | – |
| Switch-on value | <ul style="list-style-type: none"> ■ The Switch option is selected in the Operating mode parameter. ■ The Limit option is selected in the Switch output function parameter. | Enter measured value for the switch-on point. | Signed floating-point number | Depends on country and nominal diameter |
| Switch-off value | <ul style="list-style-type: none"> ■ The Switch option is selected in the Operating mode parameter. ■ The Limit option is selected in the Switch output function parameter. | Enter measured value for the switch-off point. | Signed floating-point number | – |
| Switch-on delay | <ul style="list-style-type: none"> ■ The Switch option is selected in the Operating mode parameter. ■ The Limit option is selected in the Switch output function parameter. | Define delay for the switch-on of status output. | 0.0 to 100.0 s | – |

| Parameter | Prerequisite | Description | Selection / User interface / User entry | Factory setting |
|------------------|---|---|---|-----------------|
| Switch-off delay | <ul style="list-style-type: none"> ▪ The Switch option is selected in the Operating mode parameter. ▪ The Limit option is selected in the Switch output function parameter. | Define delay for the switch-off of status output. | 0.0 to 100.0 s | – |
| Failure mode | – | Define output behavior in alarm condition. | <ul style="list-style-type: none"> ▪ Actual status ▪ Open ▪ Closed | – |

* Visibility depends on order options or device settings

9.4.11 Configuring the relay output

The **Relay output** wizard guides the user systematically through all the parameters that have to be set for configuring the relay output.

Navigation

"Setup" menu → Relay output 1 to n

| ► Relay output 1 to n | |
|----------------------------|-------|
| Terminal number | → 101 |
| Relay output function | → 101 |
| Assign limit | → 101 |
| Assign diagnostic behavior | → 101 |
| Assign status | → 101 |
| Switch-off value | → 101 |
| Switch-off delay | → 101 |
| Switch-on value | → 101 |
| Switch-on delay | → 101 |
| Failure mode | → 101 |

Parameter overview with brief description

| Parameter | Prerequisite | Description | User interface / Selection / User entry | Factory setting |
|----------------------------|---|---|--|---|
| Terminal number | – | Shows the terminal numbers used by the relay output module. | <ul style="list-style-type: none"> ■ Not used ■ 24-25 (I/O 2) ■ 22-23 (I/O 3) | – |
| Relay output function | – | Select the function for the relay output. | <ul style="list-style-type: none"> ■ Closed ■ Open ■ Diagnostic behavior ■ Limit ■ Flow direction check ■ Digital Output | – |
| Assign limit | The Limit option is selected in the Relay output function parameter. | Select process variable for limit function. | <ul style="list-style-type: none"> ■ Temperature ■ Mass flow ■ Corrected volume flow ■ FAD volume flow * ■ Volume flow * ■ Energy flow * ■ Heat flow * ■ Density ■ Flow velocity ■ 2nd temperature delta heat * ■ Electronic temperature ■ Totalizer 1 ■ Totalizer 2 ■ Totalizer 3 | – |
| Assign diagnostic behavior | In the Relay output function parameter, the Diagnostic behavior option is selected. | Select diagnostic behavior for switch output. | <ul style="list-style-type: none"> ■ Alarm ■ Alarm or warning ■ Warning | – |
| Assign status | In the Relay output function parameter, the Digital Output option is selected. | Select device status for switch output. | <ul style="list-style-type: none"> ■ Off ■ Low flow cut off | – |
| Switch-off value | In the Relay output function parameter, the Limit option is selected. | Enter measured value for the switch-off point. | Signed floating-point number | – |
| Switch-off delay | In the Relay output function parameter, the Limit option is selected. | Define delay for the switch-off of status output. | 0.0 to 100.0 s | – |
| Switch-on value | The Limit option is selected in the Relay output function parameter. | Enter measured value for the switch-on point. | Signed floating-point number | Depends on country and nominal diameter |
| Switch-on delay | In the Relay output function parameter, the Limit option is selected. | Define delay for the switch-on of status output. | 0.0 to 100.0 s | – |
| Failure mode | – | Define output behavior in alarm condition. | <ul style="list-style-type: none"> ■ Actual status ■ Open ■ Closed | – |

* Visibility depends on order options or device settings

9.4.12 Configuring the local display

The **Display** wizard guides you systematically through all the parameters that can be configured for configuring the local display.

Navigation

"Setup" menu → Display

| | | |
|-----------------------|---|-------|
| ▶ Display | | |
| Format display | → | 📄 102 |
| Value 1 display | → | 📄 102 |
| 0% bargraph value 1 | → | 📄 103 |
| 100% bargraph value 1 | → | 📄 103 |
| Value 2 display | → | 📄 103 |
| Value 3 display | → | 📄 103 |
| 0% bargraph value 3 | → | 📄 103 |
| 100% bargraph value 3 | → | 📄 103 |
| Value 4 display | → | 📄 103 |

Parameter overview with brief description

| Parameter | Prerequisite | Description | Selection / User entry | Factory setting |
|-----------------|------------------------------|---|--|-----------------|
| Format display | A local display is provided. | Select how measured values are shown on the display. | <ul style="list-style-type: none"> ▪ 1 value, max. size ▪ 1 bargraph + 1 value ▪ 2 values ▪ 1 value large + 2 values ▪ 4 values | – |
| Value 1 display | A local display is provided. | Select the measured value that is shown on the local display. | <ul style="list-style-type: none"> ▪ Temperature ▪ Mass flow ▪ Corrected volume flow ▪ FAD volume flow * ▪ Volume flow ▪ Energy flow * ▪ Heat flow * ▪ Density ▪ Flow velocity ▪ Pressure ▪ 2nd temperature delta heat * ▪ Electronic temperature ▪ Totalizer 1 ▪ Totalizer 2 ▪ Totalizer 3 ▪ Current output 1 * ▪ Current output 2 * ▪ Current output 3 * | – |

| Parameter | Prerequisite | Description | Selection / User entry | Factory setting |
|-----------------------|---|---|--|---|
| 0% bargraph value 1 | A local display is provided. | Enter 0% value for bar graph display. | Signed floating-point number | – |
| 100% bargraph value 1 | A local display is provided. | Enter 100% value for bar graph display. | Signed floating-point number | Depends on country and nominal diameter |
| Value 2 display | A local display is provided. | Select the measured value that is shown on the local display. | For the picklist, see the Value 1 display parameter (→  102) | – |
| Value 3 display | A local display is provided. | Select the measured value that is shown on the local display. | For the picklist, see the Value 1 display parameter (→  102) | – |
| 0% bargraph value 3 | A selection was made in the Value 3 display parameter. | Enter 0% value for bar graph display. | Signed floating-point number | – |
| 100% bargraph value 3 | A selection was made in the Value 3 display parameter. | Enter 100% value for bar graph display. | Signed floating-point number | – |
| Value 4 display | A local display is provided. | Select the measured value that is shown on the local display. | For the picklist, see the Value 1 display parameter (→  102) | – |
| Value 5 display | A local display is provided. | Select the measured value that is shown on the local display. | For the picklist, see the Value 1 display parameter (→  102) | – |
| Value 6 display | A local display is provided. | Select the measured value that is shown on the local display. | For the picklist, see the Value 1 display parameter (→  102) | – |
| Value 7 display | A local display is provided. | Select the measured value that is shown on the local display. | For the picklist, see the Value 1 display parameter (→  102) | – |
| Value 8 display | A local display is provided. | Select the measured value that is shown on the local display. | For the picklist, see the Value 1 display parameter (→  102) | – |

* Visibility depends on order options or device settings

9.4.13 Configuring the low flow cut off

The **Low flow cut off** wizard systematically guides the user through all the parameters that must be set to configure low flow cut off.

Navigation

"Setup" menu → Low flow cut off

| | |
|---------------------------|---------|
| ▶ Low flow cut off | |
| Assign process variable | → ⓘ 104 |
| On value low flow cutoff | → ⓘ 104 |
| Off value low flow cutoff | → ⓘ 104 |

Parameter overview with brief description

| Parameter | Prerequisite | Description | Selection / User entry | Factory setting |
|---------------------------|---|---|---|---|
| Assign process variable | – | Select process variable for low flow cut off. | <ul style="list-style-type: none"> ▪ Off ▪ Mass flow ▪ Volume flow ▪ Corrected volume flow ▪ FAD volume flow * | – |
| On value low flow cutoff | A process variable is selected in the Assign process variable parameter (→ ⓘ 104). | Enter on value for low flow cut off. | Positive floating-point number | Depends on country and nominal diameter |
| Off value low flow cutoff | A process variable is selected in the Assign process variable parameter (→ ⓘ 104). | Enter off value for low flow cut off. | 0 to 100.0 % | – |

* Visibility depends on order options or device settings

9.5 Advanced settings







The **Advanced setup** submenu with its submenus contains parameters for specific settings.

Navigation to the "Advanced setup" submenu

 The number of submenus and parameters can vary depending on the device version. Certain submenus and parameters in these submenus are not described in the Operating Instructions. Instead a description is provided in the Special Documentation for the device ("Supplementary documentation").

Navigation

"Setup" menu → Advanced setup

| | | |
|-------------------------------|---|-----|
| ▶ Advanced setup | | |
| Enter access code | →  | 105 |
| ▶ Totalizer 1 to n | →  | 105 |
| ▶ Display | →  | 107 |
| ▶ WLAN settings | →  | 110 |
| ▶ Configuration backup | →  | 112 |
| ▶ Administration | →  | 113 |

9.5.1 Using the parameter to enter the access code

Navigation

"Setup" menu → Advanced setup

Parameter overview with brief description



| Parameter | Description | User entry |
|-------------------|--|---|
| Enter access code | Enter access code to disable write protection of parameters. | Max. 16-digit character string comprising numbers, letters and special characters |



9.5.2 Configuring the totalizer

In the **"Totalizer 1 to n"** submenu the individual totalizer can be configured.



Navigation

"Setup" menu → Advanced setup → Totalizer 1 to n

| | | |
|---------------------------|---|-----|
| ▶ Totalizer 1 to n | | |
| Assign process variable | →  | 106 |
| Unit totalizer 1 to n | →  | 106 |

| | |
|--------------------------|---|
| Totalizer operation mode | →  106 |
| Failure mode | →  106 |
| Assign gas | →  106 |

Parameter overview with brief description

| Parameter | Prerequisite | Description | Selection | Factory setting |
|---|--|--|---|--|
| Assign process variable | – | Select process variable for totalizer. | <ul style="list-style-type: none"> ▪ Off ▪ Mass flow ▪ Corrected volume flow ▪ FAD volume flow * ▪ Volume flow ▪ Energy flow * ▪ Heat flow * | – |
| Unit totalizer 1 to n | A process variable is selected in the Assign process variable parameter (→  106) of the Totalizer 1 to n submenu. | Select process variable totalizer unit. | Unit choose list | – |
| Totalizer operation mode | A process variable is selected in the Assign process variable parameter (→  106) of the Totalizer 1 to n submenu. | Select totalizer calculation mode. | <ul style="list-style-type: none"> ▪ Net flow total ▪ Forward flow total ▪ Reverse flow total | – |
| Failure mode | A process variable is selected in the Assign process variable parameter (→  106) of the Totalizer 1 to n submenu. | Define totalizer behavior in alarm condition. | <ul style="list-style-type: none"> ▪ Stop ▪ Actual value ▪ Last valid value | – |
| Assign gas (Only with order code for "Application package", option EV "Second gas group") | – | Select the gas that the totalizer uses. This gas is only totalized when it is currently active ('Active gas' parameter). | <ul style="list-style-type: none"> ▪ Both gases ▪ Gas ▪ Second gas | <ul style="list-style-type: none"> ▪ Both gases option (only with order code for "Application package", option EV "Second gas group") ▪ Gas |

* Visibility depends on order options or device settings

9.5.3 Carrying out additional display configurations



In the **Display** submenu you can set all the parameters associated with the configuration of the local display.

Navigation

"Setup" menu → Advanced setup → Display

| ► Display | |
|-----------------------|-------|
| Format display | → 108 |
| Value 1 display | → 108 |
| 0% bargraph value 1 | → 108 |
| 100% bargraph value 1 | → 108 |
| Decimal places 1 | → 108 |
| Value 2 display | → 108 |
| Decimal places 2 | → 108 |
| Value 3 display | → 108 |
| 0% bargraph value 3 | → 108 |
| 100% bargraph value 3 | → 108 |
| Decimal places 3 | → 109 |
| Value 4 display | → 109 |
| Decimal places 4 | → 109 |
| Display language | → 109 |
| Display interval | → 109 |
| Display damping | → 109 |
| Header | → 109 |
| Header text | → 109 |
| Separator | → 110 |
| Backlight | → 110 |

Parameter overview with brief description

| Parameter | Prerequisite | Description | Selection / User entry | Factory setting |
|-----------------------|--|---|--|---|
| Format display | A local display is provided. | Select how measured values are shown on the display. | <ul style="list-style-type: none"> ▪ 1 value, max. size ▪ 1 bargraph + 1 value ▪ 2 values ▪ 1 value large + 2 values ▪ 4 values | – |
| Value 1 display | A local display is provided. | Select the measured value that is shown on the local display. | <ul style="list-style-type: none"> ▪ Temperature ▪ Mass flow ▪ Corrected volume flow ▪ FAD volume flow * ▪ Volume flow ▪ Energy flow * ▪ Heat flow * ▪ Density ▪ Flow velocity ▪ Pressure ▪ 2nd temperature delta heat * ▪ Electronic temperature ▪ Totalizer 1 ▪ Totalizer 2 ▪ Totalizer 3 ▪ Current output 1 * ▪ Current output 2 * ▪ Current output 3 * | – |
| 0% bargraph value 1 | A local display is provided. | Enter 0% value for bar graph display. | Signed floating-point number | – |
| 100% bargraph value 1 | A local display is provided. | Enter 100% value for bar graph display. | Signed floating-point number | Depends on country and nominal diameter |
| Decimal places 1 | A measured value is specified in the Value 1 display parameter. | Select the number of decimal places for the display value. | <ul style="list-style-type: none"> ▪ x ▪ x.x ▪ x.xx ▪ x.xxx ▪ x.xxxx | – |
| Value 2 display | A local display is provided. | Select the measured value that is shown on the local display. | For the picklist, see the Value 1 display parameter (→  102) | – |
| Decimal places 2 | A measured value is specified in the Value 2 display parameter. | Select the number of decimal places for the display value. | <ul style="list-style-type: none"> ▪ x ▪ x.x ▪ x.xx ▪ x.xxx ▪ x.xxxx | – |
| Value 3 display | A local display is provided. | Select the measured value that is shown on the local display. | For the picklist, see the Value 1 display parameter (→  102) | – |
| 0% bargraph value 3 | A selection was made in the Value 3 display parameter. | Enter 0% value for bar graph display. | Signed floating-point number | – |
| 100% bargraph value 3 | A selection was made in the Value 3 display parameter. | Enter 100% value for bar graph display. | Signed floating-point number | – |

| Parameter | Prerequisite | Description | Selection / User entry | Factory setting |
|------------------|---|---|--|---|
| Decimal places 3 | A measured value is specified in the Value 3 display parameter. | Select the number of decimal places for the display value. | <ul style="list-style-type: none"> ■ x ■ x.x ■ x.xx ■ x.xxx ■ x.xxxx | – |
| Value 4 display | A local display is provided. | Select the measured value that is shown on the local display. | For the picklist, see the Value 1 display parameter (→  102) | – |
| Decimal places 4 | A measured value is specified in the Value 4 display parameter. | Select the number of decimal places for the display value. | <ul style="list-style-type: none"> ■ x ■ x.x ■ x.xx ■ x.xxx ■ x.xxxx | – |
| Display language | A local display is provided. | Set display language. | <ul style="list-style-type: none"> ■ English ■ Deutsch ■ Français ■ Español ■ Italiano ■ Nederlands ■ Portuguesa ■ Polski ■ русский язык (Russian) ■ Svenska ■ Türkçe ■ 中文 (Chinese) ■ 日本語 (Japanese) ■ 한국어 (Korean) ■ tiếng Việt (Vietnamese) ■ čeština (Czech) | English (alternatively, the ordered language is preset in the device) |
| Display interval | A local display is provided. | Set time measured values are shown on display if display alternates between values. | 1 to 10 s | – |
| Display damping | A local display is provided. | Set display reaction time to fluctuations in the measured value. | 0.0 to 999.9 s | – |
| Header | A local display is provided. | Select header contents on local display. | <ul style="list-style-type: none"> ■ Device tag ■ Free text | – |
| Header text | The Free text option is selected in the Header parameter. | Enter display header text. | Max. 12 characters, such as letters, numbers or special characters (e.g. @, %, /) | – |

| Parameter | Prerequisite | Description | Selection / User entry | Factory setting |
|-----------|---|---|--|-----------------|
| Separator | A local display is provided. | Select decimal separator for displaying numerical values. | <ul style="list-style-type: none"> ▪ . (point) ▪ , (comma) | . (point) |
| Backlight | One of the following conditions is met: <ul style="list-style-type: none"> ▪ Order code for "Display; operation", option F "4-line, illum.; touch control" ▪ Order code for "Display; operation", option G "4-line, illum.; touch control +WLAN" ▪ Order code for "Display; operation", option O "Remote display 4-line illuminated; 10m/30ft cable; touch control" | Switch the local display backlight on and off. | <ul style="list-style-type: none"> ▪ Disable ▪ Enable | – |

* Visibility depends on order options or device settings



9.5.4 WLAN configuration

The **WLAN Settings** submenu guides the user systematically through all the parameters that have to be set for the WLAN configuration.



Navigation

"Setup" menu → Advanced setup → WLAN settings

| ▶ WLAN settings | |
|-------------------------|---------|
| WLAN | → ⓘ 111 |
| WLAN mode | → ⓘ 111 |
| SSID name | → ⓘ 111 |
| Network security | → ⓘ 111 |
| Security identification | → ⓘ 111 |
| User name | → ⓘ 111 |
| WLAN password | → ⓘ 111 |
| WLAN IP address | → ⓘ 111 |
| WLAN MAC address | → ⓘ 111 |
| WLAN passphrase | → ⓘ 111 |
| Assign SSID name | → ⓘ 111 |
| SSID name | → ⓘ 111 |

| | |
|--------------------------|---|
| Connection state | →  112 |
| Received signal strength | →  112 |

Parameter overview with brief description

| Parameter | Prerequisite | Description | Selection / User entry / User interface | Factory setting |
|-------------------------|--|--|--|--|
| WLAN | – | Switch WLAN on and off. | <ul style="list-style-type: none"> ■ Disable ■ Enable | – |
| WLAN mode | – | Select WLAN mode. | <ul style="list-style-type: none"> ■ WLAN access point ■ WLAN Client | – |
| SSID name | The client is activated. | Enter the user-defined SSID name (max. 32 characters). | – | – |
| Network security | – | Select the security type of the WLAN network. | <ul style="list-style-type: none"> ■ Unsecured ■ WPA2-PSK ■ EAP-PEAP with MSCHAPv2 * ■ EAP-PEAP MSCHAPv2 no server authentic. * ■ EAP-TLS * | – |
| Security identification | – | Select security settings and download these settings via menu Data management > Security > WLAN. | <ul style="list-style-type: none"> ■ Trusted issuer certificate ■ Device certificate ■ Device private key | – |
| User name | – | Enter user name. | – | – |
| WLAN password | – | Enter WLAN password. | – | – |
| WLAN IP address | – | Enter IP address of the WLAN interface of the device. | 4 octet: 0 to 255 (in the particular octet) | – |
| WLAN MAC address | – | Enter MAC address of the WLAN interface of the device. | Unique 12-digit character string comprising letters and numbers | Each measuring device is given an individual address. |
| WLAN passphrase | The WPA2-PSK option is selected in the Security type parameter. | Enter the network key (8 to 32 characters).  The network key supplied with the device should be changed during commissioning for security reasons. | 8 to 32-digit character string comprising numbers, letters and special characters (without spaces) | Serial number of the measuring device (e.g. L100A802000) |
| Assign SSID name | – | Select which name will be used for SSID: device tag or user-defined name. | <ul style="list-style-type: none"> ■ Device tag ■ User-defined | – |
| SSID name | <ul style="list-style-type: none"> ■ The User-defined option is selected in the Assign SSID name parameter. ■ The WLAN access point option is selected in the WLAN mode parameter. | Enter the user-defined SSID name (max. 32 characters).  The user-defined SSID name may only be assigned once. If the SSID name is assigned more than once, the devices can interfere with one another. | Max. 32-digit character string comprising numbers, letters and special characters | – |

| Parameter | Prerequisite | Description | Selection / User entry / User interface | Factory setting |
|--------------------------|--------------|-------------------------------------|---|-----------------|
| Connection state | – | Displays the connection status. | <ul style="list-style-type: none"> ▪ Connected ▪ Not connected | – |
| Received signal strength | – | Shows the received signal strength. | <ul style="list-style-type: none"> ▪ Low ▪ Medium ▪ High | – |

* Visibility depends on order options or device settings

9.5.5 Configuration management

After commissioning, you can save the current device configuration or restore the previous device configuration. The device configuration is managed via the **Configuration management** parameter.

Navigation

"Setup" menu → Advanced setup → Configuration backup

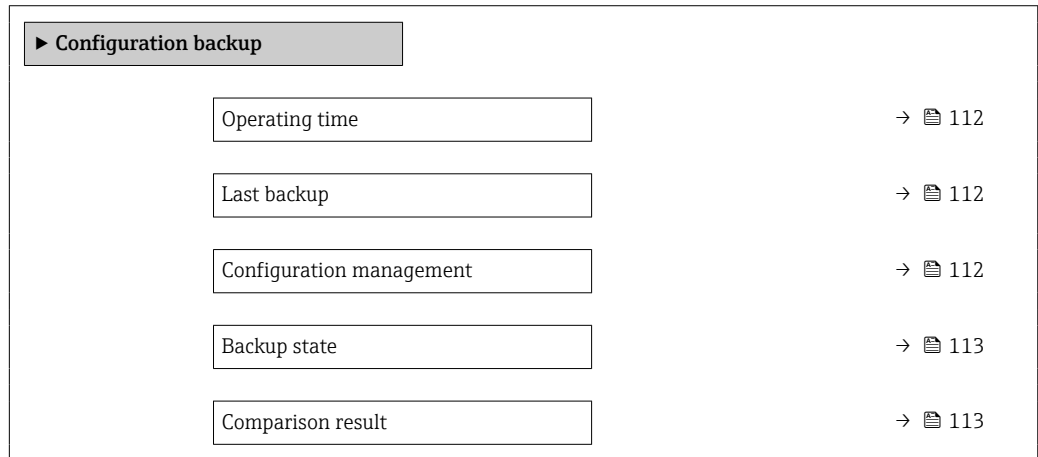

Parameter overview with brief description

| Parameter | Description | User interface / Selection |
|--------------------------|--|---|
| Operating time | Indicates how long the device has been in operation. | Days (d), hours (h), minutes (m) and seconds (s) |
| Last backup | Shows when the last data backup was saved to HistoROM backup. | Days (d), hours (h), minutes (m) and seconds (s) |
| Configuration management | Select action for managing the device data in the HistoROM backup. | <ul style="list-style-type: none"> ▪ Cancel ▪ Execute backup ▪ Restore * ▪ Compare * ▪ Clear backup data |

| Parameter | Description | User interface / Selection |
|-------------------|---|---|
| Backup state | Shows the current status of data saving or restoring. | <ul style="list-style-type: none"> ■ None ■ Backup in progress ■ Restoring in progress ■ Delete in progress ■ Compare in progress ■ Restoring failed ■ Backup failed |
| Comparison result | Comparison of current device data with HistoROM backup. | <ul style="list-style-type: none"> ■ Settings identical ■ Settings not identical ■ No backup available ■ Backup settings corrupt ■ Check not done ■ Dataset incompatible |

* Visibility depends on order options or device settings

Function scope of the "Configuration management" parameter

| Options | Description |
|-------------------|---|
| Cancel | No action is executed and the user exits the parameter. |
| Execute backup | A backup copy of the current device configuration is saved from the HistoROM backup to the memory of the device. The backup copy includes the transmitter data of the device. |
| Restore | The last backup copy of the device configuration is restored from the device memory to the device's HistoROM backup. The backup copy includes the transmitter data of the device. |
| Compare | The device configuration saved in the device memory is compared with the current device configuration of the HistoROM backup. |
| Clear backup data | The backup copy of the device configuration is deleted from the memory of the device. |

HistoROM backup

A HistoROM is a "non-volatile" device memory in the form of an EEPROM.





While this action is in progress, the configuration cannot be edited via the local display and a message on the processing status appears on the display.

9.5.6 Using parameters for device administration

The **Administration** submenu systematically guides the user through all the parameters that can be used for device administration purposes.

Navigation

"Setup" menu → Advanced setup → Administration

| | |
|----------------------|---|
| ▶ Administration | |
| ▶ Define access code | →  114 |
| ▶ Reset access code | →  114 |
| Device reset | →  115 |

Using the parameter to define the access code

Navigation

"Setup" menu → Advanced setup → Administration → Define access code

▶ Define access code

Define access code

→ 114

Confirm access code

→ 114

Parameter overview with brief description

| Parameter | Description | User entry |
|---------------------|---|---|
| Define access code | Restrict write-access to parameters to protect the configuration of the device against unintentional changes. | Max. 16-digit character string comprising numbers, letters and special characters |
| Confirm access code | Confirm the entered access code. | Max. 16-digit character string comprising numbers, letters and special characters |

Using the parameter to reset the access code

Navigation

"Setup" menu → Advanced setup → Administration → Reset access code

▶ Reset access code

Operating time

→ 114

Reset access code

→ 114

Parameter overview with brief description

| Parameter | Description | User interface / User entry |
|-------------------|--|---|
| Operating time | Indicates how long the device has been in operation. | Days (d), hours (h), minutes (m) and seconds (s) |
| Reset access code | Reset access code to factory settings. For a reset code, contact your Endress+Hauser service organization. The reset code can only be entered via: <ul style="list-style-type: none"> ▪ Web browser ▪ DeviceCare, FieldCare (via CDI-RJ45 service interface) ▪ Fieldbus | Character string comprising numbers, letters and special characters |

Using the parameter to reset the device

Navigation

"Setup" menu → Advanced setup → Administration

Parameter overview with brief description

| Parameter | Description | Selection |
|--------------|---|--|
| Device reset | Reset the device configuration - either entirely or in part - to a defined state. | <ul style="list-style-type: none"> ■ Cancel ■ To delivery settings ■ Restart device ■ Restore S-DAT backup * |

* Visibility depends on order options or device settings

9.5.7 In-situ adjustment

In-situ adjustment is used to adjust the flow output by the measuring device to the real flow of the facility. Flow profiles can be distorted by facility parts such as pipe elbows, extensions, reductions or valves. A distorted flow profile can, in turn, negatively impact the accuracy of the measuring device. By taking into consideration the actual process-specific conditions at the facility, including any effects from installation, in-situ adjustment provides flow display that is adapted to the local conditions.

In-situ adjustment can lead to better measurement results in the following cases:

- Process-specific facility conditions / installation effects
 - If the flow profile is distorted
 - For unfavorable inlet and outlet conditions
 - If the gas is unknown
 - If it is not possible to use a flow conditioner to rectify the distorted flow profile
 - If process conditions deviate significantly from reference conditions (pressure and temperature conditions of factory calibration)
- Third-party adjustments with the process gas actually used

In-situ adjustment has the following specific features:

- Can be used for both unidirectional and bidirectional sensors
- Can be defined for up to 16 flow points (for the entire operating range)
- At least one flow point is required for the adjustment but the general principle is that the more flow points that are defined, the better the measuring performance
- Measuring device can be configured without interrupting the process
- The measuring device takes account of the choice of process gas and the actual process conditions during the measurement
- The flow value can be entered manually via a display or an operating interface, or a flow value from a reference device can be read into the measuring device via a current input or bus communication

Prerequisites for optimum in-situ adjustment

- The accuracy of the flow reference used determines the performance of the measuring device adjusted in-situ. For this reason, the use of a reference device with a traceable calibration is recommended
- Calibration points all at the same temperature and pressure conditions
- Compositions of gases or gas mixtures are made available to the measuring device as these compositions are used for pressure and temperature compensation
- Precise pressure specifications are important if a volume flowmeter is used as the reference device
- If the flow values are indicated in corrected volume flow, it is important that the standard reference conditions in the reference device and in the device are identical



- For optimum results, it is advisable to use a reference device with traceable calibration for the adjustment.
 - If a reference device is not available, a fan characteristic curve, for example, can act as the

Performing in-situ adjustment

1. Select the gas: Expert → Sensor → Measurement mode → Gas → Gas
 - ↳ This entry is important for measuring device pressure and temperature compensation.
2. Activate in-situ adjustment: Expert → Sensor → In-situ adjustment → Activate in-situ adjustment
3. Confirm selection: Yes
 - ↳ If an in-situ adjustment already exists, these adjustment points are loaded. An existing adjustment (an entire series of flow points) can be deleted from the measuring device using the "Clear values" function.
4. Select the reference value: Expert → Sensor → In-situ adjustment → Select flow reference
 - ↳ If volume flow is selected, it is important that the process pressure entered in the measuring device is as accurate as possible. In the case of corrected volume flow or FAD volume flow, the defined reference operating conditions must match those of the reference measuring device.
5. Select the entry method for the reference value: Expert → Sensor → In-situ adjustment → Input type reference value
 - ↳ If "Manual" is selected, the operator must enter the flow value manually via the display (or other operating interface). However, if "Current input" or "External value" (via bus communication) is selected, the current flow values are displayed as read only reference values. The available entry modes depend on the I/O modules available.

The user can first approach the flow points with the facility. As soon as a desired flow value is reached, the value can either be saved by confirming the value or be entered as a fixed value by hand.

 The entry method depends on the selected entry mode.

The measured flow value is checked to determine its validity on the basis of the following criteria:

- Average absolute deviation of the flow value
- Standard deviation of the flow value

If a criterion is not met, the value is rejected and the message "Invalid" is displayed. If both criterion are met, the message "Passed" is displayed. If the flow value fluctuates too much, "Unstable" is displayed. If an existing adjustment is "readjusted", and with a maximum of 16 defined flow values, the flow value that is closest to the new adjusted value is replaced. Here, "Replaced" is displayed as the status.

 The user can also add a description to the adjustment. Three different text fields, with 16 alphanumeric characters per field, are available for this purpose. It is advisable to use the text fields to identify the adjustment using the name of the gas/gas mixture and the process conditions of the adjustment. If the in-situ adjustment is adjusted by a calibration laboratory with the gas that is actually used by the operator, it is advisable to also include the name of the laboratory, the date of the adjustment and the name of the operator in the description.

Special cases

Individual flow point

A maximum of 16 flow points can be defined. However, in certain situations it may not always be possible to adjust multiple flow points. In such cases, the measuring device can be adjusted with just a few operating points. The minimum number of flow points that are required is one. If only one operating point is adjusted, the measuring device uses default values to replace the missing adjustment values. Therefore, the operator should be aware

that the accuracy of the in-situ adjustment can suffer when just one flow point is defined if the measured flow is not close to the adjustment value.

Bidirectional flow

Measuring devices that are equipped with the bidirectional option can be adjusted in situ in both flow directions or in just one flow direction, as required. If the measuring device is only adjusted in one direction, it is important that the adjustment is in the positive direction (forward flow) as these adjustment points are automatically replicated to the negative direction (reverse flow).

Unknown gas composition



If the gas or gas mixture is unknown, or if the gas composition cannot be defined by the standard gas selection, the user can define the process gas as "Air". This method has the disadvantage that compensation in the event of variations in the pressure and temperature cannot be guaranteed. If the operator is not sure of the exact composition of the gas but can make an approximate guess, it is recommended to use this approximate gas composition instead of air.

"In-situ adjustment" submenu

Navigation

"Expert" menu → Sensor → In-situ adjustment

| ► In-situ adjustment | |
|-------------------------------------|---------|
| Activate in-situ adjustment (17360) | → ⓘ 118 |
| Input type reference value (17351) | → ⓘ 118 |
| Delete values (17355) | → ⓘ 118 |
| Confirm (17356) | → ⓘ 118 |
| Select flow reference (17354) | → ⓘ 118 |
| Stability check (17366) | → ⓘ 118 |
| Actual flow value (17365) | → ⓘ 118 |
| External reference value (17352) | → ⓘ 118 |
| Reference value (17353) | → ⓘ 118 |
| Apply value (17364) | → ⓘ 118 |
| Status (17367) | → ⓘ 118 |
| Description 1 (17359) | → ⓘ 118 |
| Description 2 (17358) | → ⓘ 118 |

| | |
|-----------------------------------|---|
| Description 3 (17357) | →  118 |
| Description 4 (17002) | →  118 |
| ► Adjustment values in use | →  119 |

Parameter overview with brief description

| Parameter | Description | Selection / User interface / User entry | Factory setting |
|-----------------------------|--|--|-----------------|
| Activate in-situ adjustment | Activate the in-situ adjustment. The points stored by the user are used for the in-situ adjustment. | <ul style="list-style-type: none"> ▪ No ▪ Yes | - |
| Input type reference value | Select input type for the reference value. | <ul style="list-style-type: none"> ▪ Off ▪ Manual ▪ Current input 1 * ▪ Current input 2 * ▪ Current input 3 * ▪ External value * | - |
| Delete values | Delete previous adjustment values and descriptions. | <ul style="list-style-type: none"> ▪ No ▪ Yes | - |
| Confirm | Confirm deletion. | <ul style="list-style-type: none"> ▪ No ▪ Yes | - |
| Select flow reference | Select process variable. This process variable is used as reference value for the in situ adjustment. | <ul style="list-style-type: none"> ▪ Mass flow ▪ Corrected volume flow ▪ FAD volume flow * ▪ Volume flow | - |
| Stability check | Activate stability check. New adjustment value is only accepted when the measurement is stable. | <ul style="list-style-type: none"> ▪ No ▪ Yes | - |
| Actual flow value | Shows the actual flow in relation to the maximum, factory-measured value that is adapted to the actual process conditions. | -2 000 to 2 000 % | - |
| External reference value | Shows the external reference value for the in situ adjustment. | Signed floating-point number | - |
| Reference value | Enter fixed value as reference value used for the in situ adjustment. | Signed floating-point number | - |
| Apply value | Apply the actual value. | <ul style="list-style-type: none"> ▪ No ▪ Yes | - |
| Status | Shows the validity of the actual reference value. | <ul style="list-style-type: none"> ▪ Passed ▪ Replaced ▪ Unstable ▪ Invalid | - |
| Description 1 | Description for in-situ adjustment: e.g. facility, operator, date. | - | - |
| Description 2 | Description for in-situ adjustment: e.g. facility, operator, date. | - | - |
| Description 3 | Description for in-situ adjustment: e.g. facility, operator, date. | - | - |
| Description 4 | Description for in-situ adjustment: e.g. facility, operator, date. | - | - |

* Visibility depends on order options or device settings

*"Adjustment values in use" submenu***Navigation**

"Expert" menu → Sensor → In-situ adjustment → Adjustment values in use

| ► Adjustment values in use | |
|-----------------------------|-------|
| Gas description 1/2 (17361) | → 120 |
| Gas description 2/2 (17362) | → 120 |
| Flow value 1 (17368) | → 120 |
| Flow value 2 (17369) | → 120 |
| Flow value 3 (17370) | → 120 |
| Flow value 4 (17371) | → 120 |
| Flow value 5 (17372) | → 120 |
| Flow value 6 (17373) | → 120 |
| Flow value 7 (17374) | → 120 |
| Flow value 8 (17375) | → 120 |
| Flow value 9 (17376) | → 120 |
| Flow value 10 (17377) | → 120 |
| Flow value 11 (17378) | → 120 |
| Flow value 12 (17379) | → 120 |
| Flow value 13 (17380) | → 120 |
| Flow value 14 (17381) | → 120 |
| Flow value 15 (17382) | → 120 |
| Flow value 16 (17383) | → 120 |

Parameter overview with brief description

| Parameter | Description | User interface | Factory setting |
|---------------------|--|-------------------|-----------------|
| Gas description 1/2 | Shows the 1st part of the description of the set gas used in the in-situ adjustment. | - | - |
| Gas description 2/2 | Shows the 2nd part of the description of the set gas used in the in-situ adjustment. | - | - |
| Flow value 1 | Shows the stored flow value in relation to the maximum, factory-measured value that is adapted to the actual process conditions. | -2 000 to 2 000 % | - |
| Flow value 2 | Shows the stored flow value in relation to the maximum, factory-measured value that is adapted to the actual process conditions. | -2 000 to 2 000 % | - |
| Flow value 3 | Shows the stored flow value in relation to the maximum, factory-measured value that is adapted to the actual process conditions. | -2 000 to 2 000 % | - |
| Flow value 4 | Shows the stored flow value in relation to the maximum, factory-measured value that is adapted to the actual process conditions. | -2 000 to 2 000 % | - |
| Flow value 5 | Shows the stored flow value in relation to the maximum, factory-measured value that is adapted to the actual process conditions. | -2 000 to 2 000 % | - |
| Flow value 6 | Shows the stored flow value in relation to the maximum, factory-measured value that is adapted to the actual process conditions. | -2 000 to 2 000 % | - |
| Flow value 7 | Shows the stored flow value in relation to the maximum, factory-measured value that is adapted to the actual process conditions. | -2 000 to 2 000 % | - |
| Flow value 8 | Shows the stored flow value in relation to the maximum, factory-measured value that is adapted to the actual process conditions. | -2 000 to 2 000 % | - |
| Flow value 9 | Shows the stored flow value in relation to the maximum, factory-measured value that is adapted to the actual process conditions. | -2 000 to 2 000 % | - |
| Flow value 10 | Shows the stored flow value in relation to the maximum, factory-measured value that is adapted to the actual process conditions. | -2 000 to 2 000 % | - |
| Flow value 11 | Shows the stored flow value in relation to the maximum, factory-measured value that is adapted to the actual process conditions. | -2 000 to 2 000 % | - |
| Flow value 12 | Shows the stored flow value in relation to the maximum, factory-measured value that is adapted to the actual process conditions. | -2 000 to 2 000 % | - |
| Flow value 13 | Shows the stored flow value in relation to the maximum, factory-measured value that is adapted to the actual process conditions. | -2 000 to 2 000 % | - |
| Flow value 14 | Shows the stored flow value in relation to the maximum, factory-measured value that is adapted to the actual process conditions. | -2 000 to 2 000 % | - |
| Flow value 15 | Shows the stored flow value in relation to the maximum, factory-measured value that is adapted to the actual process conditions. | -2 000 to 2 000 % | - |
| Flow value 16 | Shows the stored flow value in relation to the maximum, factory-measured value that is adapted to the actual process conditions. | -2 000 to 2 000 % | - |

9.6 Configuration management

After commissioning, you can save the current device configuration or restore the previous device configuration. The device configuration is managed via the **Configuration management** parameter.

Navigation

"Setup" menu → Advanced setup → Configuration backup

| ► Configuration backup | | |
|--------------------------|--|---------|
| Operating time | | → ⓘ 112 |
| Last backup | | → ⓘ 112 |
| Configuration management | | → ⓘ 112 |
| Backup state | | → ⓘ 113 |
| Comparison result | | → ⓘ 113 |

Parameter overview with brief description

| Parameter | Description | User interface / Selection |
|--------------------------|--|---|
| Operating time | Indicates how long the device has been in operation. | Days (d), hours (h), minutes (m) and seconds (s) |
| Last backup | Shows when the last data backup was saved to HistoROM backup. | Days (d), hours (h), minutes (m) and seconds (s) |
| Configuration management | Select action for managing the device data in the HistoROM backup. | <ul style="list-style-type: none"> ■ Cancel ■ Execute backup ■ Restore ■ Compare ■ Clear backup data |
| Backup state | Shows the current status of data saving or restoring. | <ul style="list-style-type: none"> ■ None ■ Backup in progress ■ Restoring in progress ■ Delete in progress ■ Compare in progress ■ Restoring failed ■ Backup failed |
| Comparison result | Comparison of current device data with HistoROM backup. | <ul style="list-style-type: none"> ■ Settings identical ■ Settings not identical ■ No backup available ■ Backup settings corrupt ■ Check not done ■ Dataset incompatible |

9.6.1 Function scope of the "Configuration management" parameter

| Options | Description |
|----------------|---|
| Cancel | No action is executed and the user exits the parameter. |
| Execute backup | A backup copy of the current device configuration is saved from the HistoROM backup to the memory of the device. The backup copy includes the transmitter data of the device. |

| Options | Description |
|-------------------|---|
| Restore | The last backup copy of the device configuration is restored from the device memory to the device's HistoROM backup. The backup copy includes the transmitter data of the device. |
| Compare | The device configuration saved in the device memory is compared with the current device configuration of the HistoROM backup. |
| Clear backup data | The backup copy of the device configuration is deleted from the memory of the device. |

HistoROM backup

A HistoROM is a "non-volatile" device memory in the form of an EEPROM.













 While this action is in progress, the configuration cannot be edited via the local display and a message on the processing status appears on the display.

9.7 Simulation

Via the **Simulation** submenu, it is possible to simulate various process variables in the process and the device alarm mode and verify downstream signal chains (switching valves or closed-control loops). The simulation can be performed without a real measurement (no flow of medium through the device).

Navigation

"Diagnostics" menu → Simulation

| ▶ Simulation | |
|------------------------------------|---|
| Assign simulation process variable | →  123 |
| Process variable value | →  123 |
| Current input 1 to n simulation | →  124 |
| Value current input 1 to n | →  124 |
| Status input simulation 1 to n | →  124 |
| Input signal level 1 to n | →  124 |
| Current output 1 to n simulation | →  123 |
| Value current output 1 to n | →  123 |
| Frequency output simulation 1 to n | →  123 |
| Frequency value 1 to n | →  123 |
| Pulse output simulation 1 to n | →  123 |
| Pulse value 1 to n | →  123 |

| | |
|---------------------------------|-------|
| Switch output simulation 1 to n | → 123 |
| Switch status 1 to n | → 123 |
| Relay output 1 to n simulation | → 123 |
| Switch status 1 to n | → 124 |
| Device alarm simulation | → 124 |
| Diagnostic event category | → 124 |
| Diagnostic event simulation | → 124 |

Parameter overview with brief description



| Parameter | Prerequisite | Description | Selection / User entry |
|------------------------------------|--|---|--|
| Assign simulation process variable | – | Select a process variable for the simulation process that is activated. | <ul style="list-style-type: none"> ■ Off ■ Temperature ■ Mass flow ■ Corrected volume flow ■ FAD volume flow * ■ Volume flow ■ Energy flow * ■ Heat flow * ■ Density ■ Flow velocity |
| Process variable value | A process variable is selected in the Assign simulation process variable parameter (→ 123). | Enter the simulation value for the selected process variable. | Depends on the process variable selected |
| Current output 1 to n simulation | – | Switch the simulation of the current output on and off. | <ul style="list-style-type: none"> ■ Off ■ On |
| Value current output 1 to n | In the Current output 1 to n simulation parameter, the On option is selected. | Enter the current value for simulation. | 3.59 to 22.5 mA |
| Frequency output simulation 1 to n | In the Operating mode parameter, the Frequency option is selected. | Switch the simulation of the frequency output on and off. | <ul style="list-style-type: none"> ■ Off ■ On |
| Frequency value 1 to n | In the Frequency output simulation 1 to n parameter, the On option is selected. | Enter the frequency value for the simulation. | 0.0 to 12 500.0 Hz |
| Pulse output simulation 1 to n | In the Operating mode parameter, the Pulse option is selected. | Set and switch off the pulse output simulation.  For Fixed value option: Pulse width parameter (→ 95) defines the pulse width of the pulses output. | <ul style="list-style-type: none"> ■ Off ■ Fixed value ■ Down-counting value |
| Pulse value 1 to n | In the Pulse output simulation 1 to n parameter, the Down-counting value option is selected. | Enter the number of pulses for simulation. | 0 to 65 535 |
| Switch output simulation 1 to n | In the Operating mode parameter, the Switch option is selected. | Switch the simulation of the switch output on and off. | <ul style="list-style-type: none"> ■ Off ■ On |
| Switch status 1 to n | – | Select the status of the status output for the simulation. | <ul style="list-style-type: none"> ■ Open ■ Closed |
| Relay output 1 to n simulation | – | Switch simulation of the relay output on and off. | <ul style="list-style-type: none"> ■ Off ■ On |

| Parameter | Prerequisite | Description | Selection / User entry |
|---------------------------------|---|---|---|
| Switch status 1 to n | The On option is selected in the Switch output simulation 1 to n parameter parameter. | Select status of the relay output for the simulation. | <ul style="list-style-type: none"> ▪ Open ▪ Closed |
| Device alarm simulation | – | Switch the device alarm on and off. | <ul style="list-style-type: none"> ▪ Off ▪ On |
| Diagnostic event category | – | Select a diagnostic event category. | <ul style="list-style-type: none"> ▪ Sensor ▪ Electronics ▪ Configuration ▪ Process |
| Diagnostic event simulation | – | Select a diagnostic event to simulate this event. | <ul style="list-style-type: none"> ▪ Off ▪ Diagnostic event picklist (depends on the category selected) |
| Current input 1 to n simulation | – | Switch simulation of the current input on and off. | <ul style="list-style-type: none"> ▪ Off ▪ On |
| Value current input 1 to n | In the Current input 1 to n simulation parameter, the On option is selected. | Enter the current value for simulation. | 0 to 22.5 mA |
| Status input simulation 1 to n | – | Switch simulation of the status input on and off. | <ul style="list-style-type: none"> ▪ Off ▪ On |
| Input signal level 1 to n | In the Status input simulation parameter, the On option is selected. | Select the signal level for the simulation of the status input. | <ul style="list-style-type: none"> ▪ High ▪ Low |

* Visibility depends on order options or device settings

9.8 Protecting settings from unauthorized access

The following write protection options exist in order to protect the configuration of the measuring device from unintentional modification:

- Protect access to parameters via access code →  124
- Protect access to local operation via key locking →  59
- Protect access to measuring device via write protection switch →  126







9.8.1 Write protection via access code

The effects of the user-specific access code are as follows:

- Via local operation, the parameters for the measuring device configuration are write-protected and their values can no longer be changed.
- Device access is protected via the Web browser, as are the parameters for the measuring device configuration.
- Device access is protected via FieldCare or DeviceCare (via CDI-RJ45 service interface), as are the parameters for the measuring device configuration.

Defining the access code via the local display

1. Navigate to the **Define access code** parameter (→  114).
2. Maximum of 16-digit character string comprising numbers, letters and special characters as the access code.





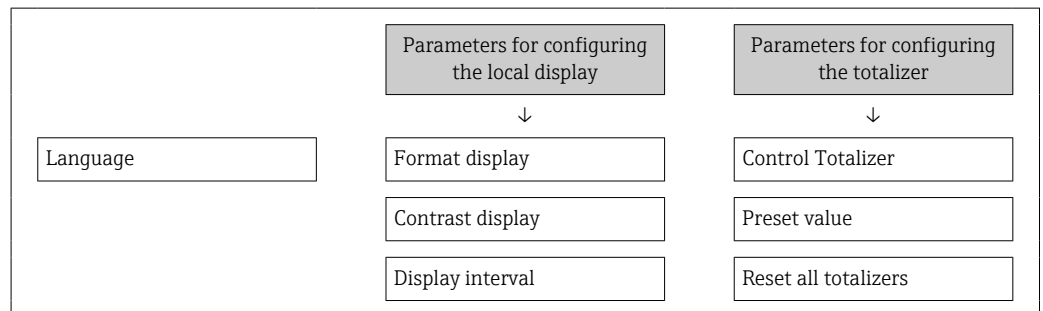

3. Enter the access code again in the **Confirm access code** parameter (→  114) to confirm.
 - ↳ The  symbol appears in front of all write-protected parameters.
- 
 - Disabling parameter write protection via access code →  58.
 - If the access code is lost: Resetting the access code →  125.
 - The user role with which the user is currently logged in is displayed in **Access status** parameter.
 - Navigation path: Operation → Access status
 - User roles and their access rights →  58
 - The device automatically locks the write-protected parameters again if a key is not pressed for 10 minutes in the navigation and editing view.
 - The device locks the write-protected parameters automatically after 60 s if the user skips back to the operational display mode from the navigation and editing view.

Parameters which can always be modified via the local display

Certain parameters that do not affect the measurement are excepted from parameter write protection via the local display. Despite the user-specific access code, they can always be modified, even if the other parameters are locked.



Defining the access code via the web browser

1. Navigate to the **Define access code** parameter (→  114).
 2. Define a 16-digit (max.) numeric code as the access code.
 3. Enter the access code again in the **Confirm access code** parameter (→  114) to confirm.
 - ↳ The web browser switches to the login page.
- 
 - Disabling parameter write protection via access code →  58.
 - If the access code is lost: Resetting the access code →  125.
 - The user role with which the user is currently logged in is displayed in the **Access status** parameter.
 - Navigation path: Operation → Access status
 - User roles and their access rights →  58



If no action is performed for 10 minutes, the web browser automatically returns to the login page.

Resetting the access code

If you misplace the user-specific access code, it is possible to reset the code to the factory setting. A reset code must be entered for this purpose. The user-specific access code can then be defined again afterwards.

Via Web browser, FieldCare, DeviceCare (via CDI-RJ45 service interface), fieldbus

i You can only obtain a reset code from your local Endress+Hauser service organization. The code must be calculated explicitly for every device.

1. Note down the serial number of the device.
2. Read off the **Operating time** parameter.
3. Contact the local Endress+Hauser service organization and tell them the serial number and the operating time.
 - ↳ Get the calculated reset code.
4. Enter the reset code in the **Reset access code** parameter (→  114).
 - ↳ The access code has been reset to the factory setting **0000**. It can be redefined →  124.

i For IT security reasons, the calculated reset code is only valid for 96 hours from the specified operating time and for the specific serial number. If you cannot return to the device within 96 hours, you should either increase the operating time you read out by a few days or switch off the device.

9.8.2 Write protection via write protection switch



Unlike parameter write protection via a user-specific access code, this allows the user to lock write access to the entire operating menu - apart from the **"Contrast display" parameter**.

The parameter values are now read only and cannot be edited any more (exception **"Contrast display" parameter**):

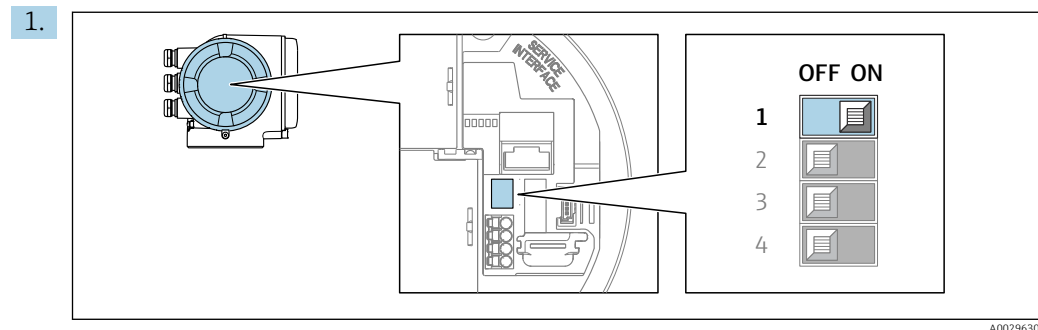

- Via local display
- Via HART protocol

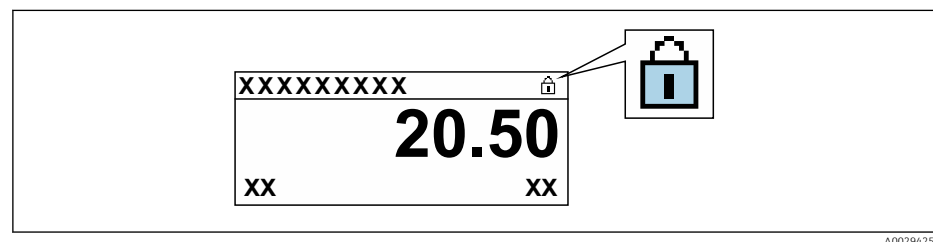

Setting the write protection (WP) switch on the main electronics module to the **ON** position enables hardware write protection.

- ↳ In the **Locking status** parameter, the **Hardware locked** option is displayed →  128. In addition, on the local display the  symbol appears in front of the parameters in the header of the operational display and in the navigation view.



2. Setting the write protection (WP) switch on the main electronics module to the **OFF** position (factory setting) disables hardware write protection.
 - ↳ No option is displayed in the **Locking status** parameter →  128. On the local display, the  symbol disappears from in front of the parameters in the header of the operational display and in the navigation view.



10 Operation

10.1 Reading off the device locking status

Device active write protection: **Locking status** parameter



Operation → Locking status

Function scope of the "Locking status" parameter

| Options | Description |
|--------------------|--|
| None | The access authorization displayed in the Access status parameter applies →  58. Only appears on local display. |
| Hardware locked | The DIP switch for hardware locking is activated on the PCB board. This locks write access to the parameters (e.g. via local display or operating tool) →  126. |
| SIL locked | The SIL mode is enabled. This locks write access to the parameters (e.g. via local display or operating tool). |
| Temporarily locked | Write access to the parameters is temporarily locked on account of internal processes running in the device (e.g. data upload/download, reset, etc.). Once the internal processing has been completed, the parameters can be changed once again. |



10.2 Adjusting the operating language

 Detailed information:

- To configure the operating language →  78
- For information on the operating languages supported by the measuring device →  194

10.3 Configuring the display

Detailed information:



- On the basic settings for the local display →  101
- On the advanced settings for the local display →  107

10.4 Reading off measured values

With the **Measured values** submenu, it is possible to read all the measured values.

Navigation

"Diagnostics" menu → Measured values

| | |
|---------------------|---|
| ▶ Measured values | |
| ▶ Process variables | →  129 |
| ▶ System values | →  130 |
| ▶ Input values | →  131 |

| | |
|-----------------|-------|
| ▶ Output values | → 132 |
| ▶ Totalizer | → 130 |

10.4.1 Process variables

The **Process variables** submenu contains all the parameters needed to display the current measured values for each process variable.

Navigation

"Diagnostics" menu → Measured values → Process variables

| | |
|-----------------------|-------|
| ▶ Process variables | |
| Mass flow | → 129 |
| Corrected volume flow | → 129 |
| Volume flow | → 129 |
| FAD volume flow | → 130 |
| Energy flow | → 130 |
| Temperature | → 130 |
| Density | → 130 |
| Flow velocity | → 130 |
| Heat flow | → 130 |

Parameter overview with brief description

| Parameter | Prerequisite | Description | User interface |
|-----------------------|--------------|---|------------------------------|
| Mass flow | – | Displays the mass flow that is currently measured. <i>Dependency</i> The unit is taken from: Mass flow unit parameter (→ 87) | Signed floating-point number |
| Corrected volume flow | – | Displays the corrected volume flow that is currently calculated. <i>Dependency</i> The unit is taken from the Corrected volume flow unit parameter (→ 87). | Signed floating-point number |
| Volume flow | – | Displays the volume flow that is currently measured. <i>Dependency</i> The unit is taken from the Volume flow unit parameter (→ 87). | Signed floating-point number |

| Parameter | Prerequisite | Description | User interface |
|-----------------|--|---|------------------------------|
| FAD volume flow | The Air or compressed air option is selected in the Measurement application parameter. | Displays the FAD volume flow that is currently calculated. <i>Dependency</i> The unit is taken from: FAD volume flow unit parameter (→ ⓘ 87) | Signed floating-point number |
| Energy flow | The Energy option is selected in the Measurement application parameter. | Shows the energy flow currently calculated. | Signed floating-point number |
| Temperature | – | Displays the temperature that is currently measured. <i>Dependency</i> The unit is taken from: Temperature unit parameter (→ ⓘ 88) | Signed floating-point number |
| Density | – | Shows the density currently calculated. | Signed floating-point number |
| Flow velocity | – | Shows the flow velocity currently calculated. | Signed floating-point number |
| Heat flow | The Energy option is selected in the Measurement application parameter. | Shows the heat flow currently calculated. | Signed floating-point number |

10.4.2 System values

The **System values** submenu contains all the parameters needed to display the current measured values for every system value.

Navigation

"Diagnostics" menu → Measured values → System values

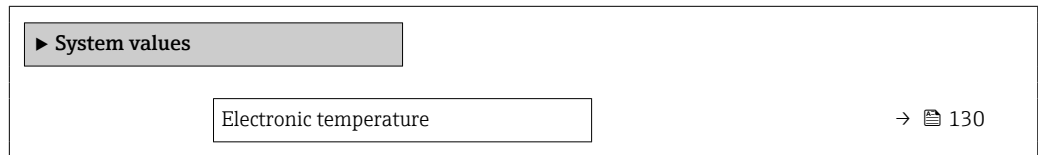

Parameter overview with brief description

| Parameter | Description | User interface |
|------------------------|---|------------------------------|
| Electronic temperature | Indication of the current temperature of the electronics. | Signed floating-point number |

10.4.3 "Totalizer" submenu

The **Totalizer** submenu contains all the parameters needed to display the current measured values for every totalizer.

Navigation

"Diagnostics" menu → Measured values → Totalizer

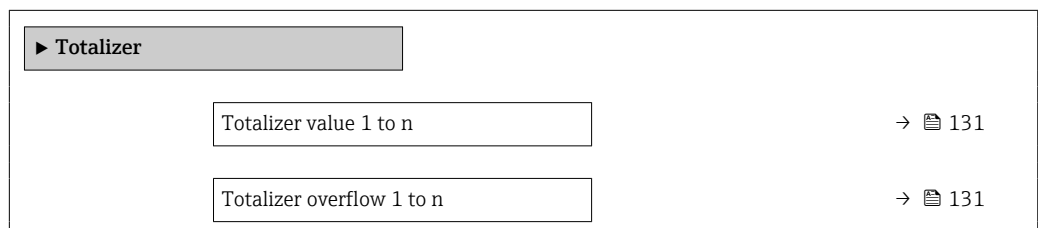

Parameter overview with brief description

| Parameter | Description | User interface |
|---------------------------|---|------------------------------|
| Totalizer value 1 to n | Displays the current totalizer counter value. | Signed floating-point number |
| Totalizer overflow 1 to n | Displays the current totalizer overflow. | Integer with sign |

10.4.4 "Input values" submenu

The **Input values** submenu guides you systematically to the individual input values.

Navigation

"Diagnostics" menu → Measured values → Input values

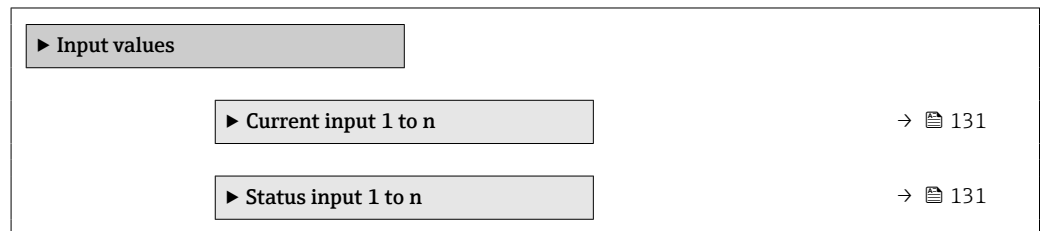

Input values of current input

The **Current input 1 to n** submenu contains all the parameters needed to display the current measured values for every current input.

Navigation

"Diagnostics" menu → Measured values → Input values → Current input 1 to n

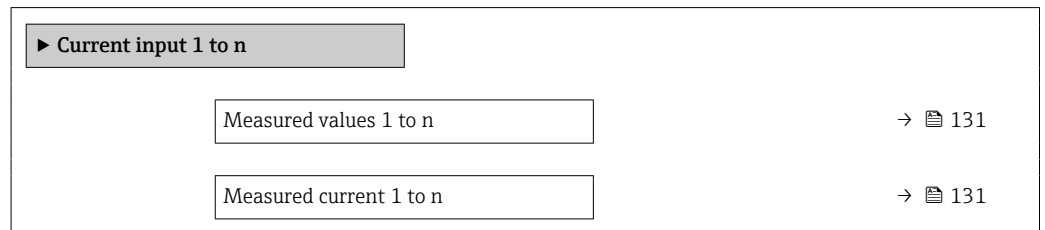

Parameter overview with brief description

| Parameter | Description | User interface |
|-------------------------|--|------------------------------|
| Measured values 1 to n | Displays the current input value. | Signed floating-point number |
| Measured current 1 to n | Displays the current value of the current input. | 0 to 22.5 mA |

Input values of status input

The **Status input 1 to n** submenu contains all the parameters needed to display the current measured values for every status input.

Navigation

"Diagnostics" menu → Measured values → Input values → Status input 1 to n

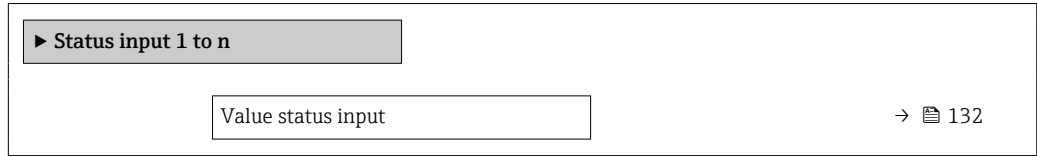

Parameter overview with brief description

| Parameter | Description | User interface |
|--------------------|---------------------------------------|---|
| Value status input | Shows the current input signal level. | <ul style="list-style-type: none"> ▪ High ▪ Low |

10.4.5 Output values

The **Output values** submenu contains all the parameters needed to display the current measured values for every output.

Navigation

"Diagnostics" menu → Measured values → Output values

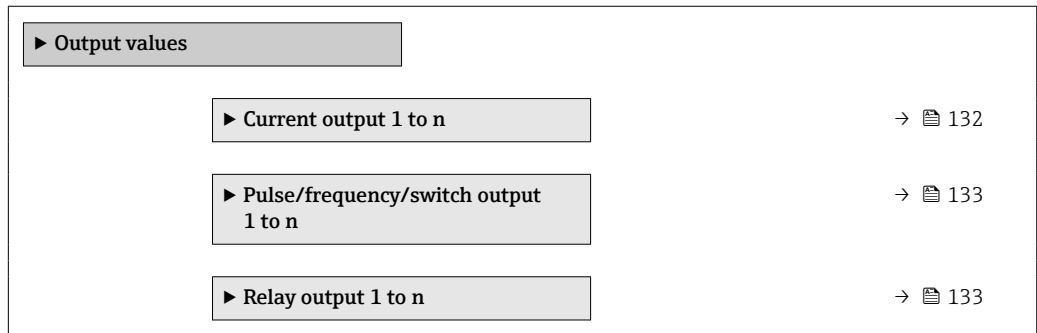

Output values of current output

The **Value current output** submenu contains all the parameters needed to display the current measured values for every current output.

Navigation

"Diagnostics" menu → Measured values → Output values → Value current output 1 to n

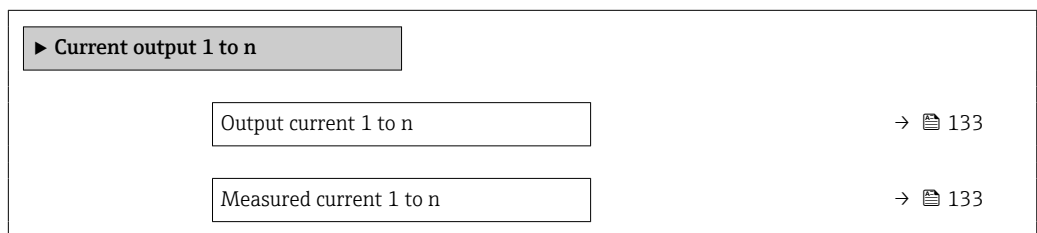

Parameter overview with brief description

| Parameter | Description | User interface |
|------------------|---|-----------------|
| Output current 1 | Displays the current value currently calculated for the current output. | 3.59 to 22.5 mA |
| Measured current | Displays the current value currently measured for the current output. | 0 to 30 mA |

Output values for pulse/frequency/switch output

The **Pulse/frequency/switch output 1 to n** submenu contains all the parameters needed to display the current measured values for every pulse/frequency/switch output.

Navigation

"Diagnostics" menu → Measured values → Output values → Pulse/frequency/switch output 1 to n

▶ **Pulse/frequency/switch output 1 to n**

| | |
|-------------------------|---------|
| Output frequency 1 to n | → ⓘ 133 |
| Pulse output 1 to n | → ⓘ 133 |
| Switch status 1 to n | → ⓘ 133 |

Parameter overview with brief description

| Parameter | Prerequisite | Description | User interface |
|-------------------------|---|---|--|
| Output frequency 1 to n | In the Operating mode parameter, the Frequency option is selected. | Displays the value currently measured for the frequency output. | 0.0 to 12 500.0 Hz |
| Pulse output 1 to n | The Pulse option is selected in the Operating mode parameter parameter. | Displays the pulse frequency currently output. | Positive floating-point number |
| Switch status 1 to n | The Switch option is selected in the Operating mode parameter. | Displays the current switch output status. | <ul style="list-style-type: none"> ▪ Open ▪ Closed |

Output values for relay output

The **Relay output 1 to n** submenu contains all the parameters needed to display the current measured values for every relay output.

Navigation

"Diagnostics" menu → Measured values → Output values → Relay output 1 to n

▶ **Relay output 1 to n**



| | |
|---------------------------|---------|
| Switch status | → ⓘ 134 |
| Switch cycles | → ⓘ 134 |
| Max. switch cycles number | → ⓘ 134 |

Parameter overview with brief description

| Parameter | Description | User interface |
|---------------------------|---|--|
| Switch status | Shows the current relay switch status. | <ul style="list-style-type: none"> ▪ Open ▪ Closed |
| Switch cycles | Shows number of all performed switch cycles. | Positive integer |
| Max. switch cycles number | Shows the maximal number of guaranteed switch cycles. | Positive integer |

10.5 Adapting the measuring device to the process conditions

The following are available for this purpose:

- Basic settings using the **Setup** menu (→  79)
- Advanced settings using the **Advanced setup** submenu (→  105)





10.6 Performing a totalizer reset

The totalizers are reset in the **Operation** submenu:





- Control Totalizer
- Reset all totalizers

Navigation

"Operation" menu → Totalizer handling

| | |
|---|---|
| <div style="border: 1px solid black; padding: 5px; margin-bottom: 10px;"> ▶ Totalizer handling </div> | |
| Control Totalizer 1 to n | →  134 |
| Preset value 1 to n | →  134 |
| Totalizer value 1 to n | →  135 |
| Reset all totalizers | →  135 |

Parameter overview with brief description

| Parameter | Prerequisite | Description | Selection / User entry / User interface |
|--------------------------|--|---|--|
| Control Totalizer 1 to n | A process variable is selected in the Assign process variable parameter (→  106) of the Totalizer 1 to n submenu. | Control totalizer value. | <ul style="list-style-type: none"> ▪ Totalize ▪ Reset + hold ▪ Preset + hold ▪ Reset + totalize ▪ Preset + totalize ▪ Hold |
| Preset value 1 to n | A process variable is selected in the Assign process variable parameter (→  106) of the Totalizer 1 to n submenu. | Specify start value for totalizer. <i>Dependency</i>  The unit of the selected process variable is defined in the Unit totalizer parameter (→  106) for the totalizer. | Signed floating-point number |

| Parameter | Prerequisite | Description | Selection / User entry / User interface |
|----------------------|--------------|---|--|
| Totalizer value | - | Displays the current totalizer counter value. | Signed floating-point number |
| Reset all totalizers | - | Reset all totalizers to 0 and start. | <ul style="list-style-type: none"> ■ Cancel ■ Reset + totalize |

10.6.1 Function scope of "Control Totalizer" parameter

| Options | Description |
|---------------------------------|---|
| Totalize | The totalizer is started or continues running. |
| Reset + hold | The totaling process is stopped and the totalizer is reset to 0. |
| Preset + hold ¹⁾ | The totaling process is stopped and the totalizer is set to its defined start value from the Preset value parameter. |
| Reset + totalize | The totalizer is reset to 0 and the totaling process is restarted. |
| Preset + totalize ¹⁾ | The totalizer is set to the defined start value in the Preset value parameter and the totaling process is restarted. |
| Hold | Totalizing is stopped. |



1) Visible depending on the order options or device settings

10.6.2 Function range of "Reset all totalizers" parameter

| Options | Description |
|------------------|---|
| Cancel | No action is executed and the user exits the parameter. |
| Reset + totalize | Resets all totalizers to 0 and restarts the totaling process. This deletes all the previously aggregated flow values. |

10.7 Displaying data logging

The **Extended HistorOM** application package must be enabled in the device (order option) for the **Data logging** submenu to appear. This contains all the parameters for the measured value history.

-  Data logging is also available via:
- Plant Asset Management Tool FieldCare →  69.
 - Web browser

Function range

- A total of 1000 measured values can be stored
- 4 logging channels
- Adjustable logging interval for data logging
- Display of the measured value trend for each logging channel in the form of a chart

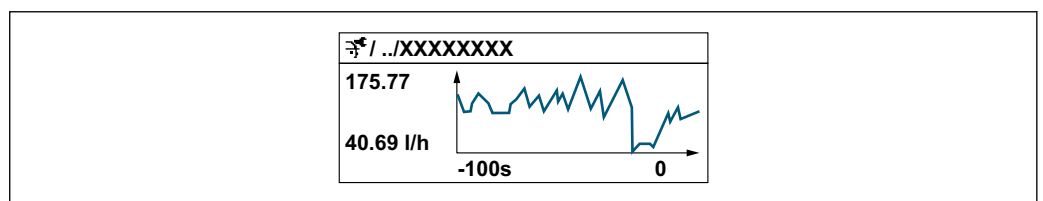

A0034352







- x-axis: depending on the number of channels selected displays 250 to 1000 measured values of a process variable.
 - y-axis: displays the approximate measured value span and constantly adapts this to the ongoing measurement.
- i** If the length of the logging interval or the assignment of the process variables to the channels is changed, the content of the data logging is deleted.

Navigation

"Diagnostics" menu → Data logging

| | |
|----------------------------|--------|
| ► Data logging | |
| Assign channel 1 | → 137 |
| Assign channel 2 | → 137 |
| Assign channel 3 | → 137 |
| Assign channel 4 | → 137 |
| Logging interval | → 137 |
| Clear logging data | → 137 |
| Data logging | → 137 |
| Logging delay | → 137 |
| Data logging control | → 137 |
| Data logging status | → 137 |
| Entire logging duration | → 137 |
| ► Display channel 1 | |
| ► Display channel 2 | |
| ► Display channel 3 | |
| ► Display channel 4 | |

Parameter overview with brief description

| Parameter | Prerequisite | Description | Selection / User entry / User interface |
|-------------------------|--|--|--|
| Assign channel 1 | The Extended HistoROM application package is available. | Assign process variable to logging channel. | <ul style="list-style-type: none"> ■ Off ■ Temperature ■ Mass flow ■ Corrected volume flow ■ FAD volume flow[*] ■ Volume flow ■ Energy flow ■ Heat flow[*] ■ Density ■ Flow velocity ■ Pressure ■ 2nd temperature delta heat[*] ■ Electronic temperature ■ Current output 1[*] ■ Current output 2[*] ■ Current output 3[*] ■ Current output 4[*] |
| Assign channel 2 | The Extended HistoROM application package is available.  The software options currently enabled are displayed in the Software option overview parameter. | Assign a process variable to logging channel. | For the picklist, see the Assign channel 1 parameter (→  137) |
| Assign channel 3 | The Extended HistoROM application package is available.  The software options currently enabled are displayed in the Software option overview parameter. | Assign a process variable to logging channel. | For the picklist, see the Assign channel 1 parameter (→  137) |
| Assign channel 4 | The Extended HistoROM application package is available.  The software options currently enabled are displayed in the Software option overview parameter. | Assign a process variable to logging channel. | For the picklist, see the Assign channel 1 parameter (→  137) |
| Logging interval | The Extended HistoROM application package is available. | Define the logging interval for data logging. This value defines the time interval between the individual data points in the memory. | 0.1 to 3 600.0 s |
| Clear logging data | The Extended HistoROM application package is available. | Clear the entire logging data. | <ul style="list-style-type: none"> ■ Cancel ■ Clear data |
| Data logging | – | Select the type of data logging. | <ul style="list-style-type: none"> ■ Overwriting ■ Not overwriting |
| Logging delay | In the Data logging parameter, the Not overwriting option is selected. | Enter the time delay for measured value logging. | 0 to 999 h |
| Data logging control | In the Data logging parameter, the Not overwriting option is selected. | Start and stop measured value logging. | <ul style="list-style-type: none"> ■ None ■ Delete + start ■ Stop |
| Data logging status | In the Data logging parameter, the Not overwriting option is selected. | Displays the measured value logging status. | <ul style="list-style-type: none"> ■ Done ■ Delay active ■ Active ■ Stopped |
| Entire logging duration | In the Data logging parameter, the Not overwriting option is selected. | Displays the total logging duration. | Positive floating-point number |

* Visibility depends on order options or device settings

11 Diagnostics and troubleshooting

11.1 General troubleshooting











For local display

| Error | Possible causes | Remedial action |
|---|---|--|
| Local display is dark, but signal output is within the valid range | The cable of the display module is not plugged in correctly. | Insert the plug correctly into the main electronics module and display module. |
| Local display dark and no output signals | Supply voltage does not match the voltage specified on the nameplate. | Apply the correct supply voltage → 36. |
| Local display dark and no output signals | Supply voltage has incorrect polarity. | Reverse polarity of supply voltage. |
| Local display dark and no output signals | No contact between connecting cables and terminals. | Ensure electrical contact between the cable and the terminal. |
| Local display dark and no output signals | <ul style="list-style-type: none"> ▪ Terminals are not plugged into the I/O electronics module correctly. ▪ Terminals are not plugged into the main electronics module correctly. | Check terminals. |
| Local display dark and no output signals | <ul style="list-style-type: none"> ▪ I/O electronics module is defective. ▪ Main electronics module is defective. | Order spare part → 166. |
| Local display cannot be read, but signal output is within the valid range | Display is set too bright or too dark. | <ul style="list-style-type: none"> ▪ Set the display brighter by simultaneously pressing $\square + \square$. ▪ Set the display darker by simultaneously pressing $\square + \square$. |
| Local display is dark, but signal output is within the valid range | Display module is defective. | Order spare part → 166. |
| Backlighting of local display is red | Diagnostic event with "Alarm" diagnostic behavior has occurred. | Take remedial measures → 151 |
| Text on local display appears in a language that cannot be understood. | The selected operating language cannot be understood. | <ol style="list-style-type: none"> 1. Press $\square + \square$ for 2 s ("home position"). 2. Press \square. 3. Configure the required language in the Display language parameter (→ 109). |
| Message on local display: "Communication Error" "Check Electronics" | Communication between the display module and the electronics is interrupted. | <ul style="list-style-type: none"> ▪ Check the cable and the connector between the main electronics module and display module. ▪ Order spare part → 166. |

For output signals

| Error | Possible causes | Remedial action |
|---|---|---|
| Signal output outside the valid range | Main electronics module is defective. | Order spare part → 166. |
| Signal output outside the valid current range (< 3.6 mA or > 22 mA) | Main electronics module is defective. I/O electronics module is defective. | Order spare part → 166. |
| Device shows correct value on local display, but signal output is incorrect, though in the valid range. | Parameter configuration error | Check and adjust parameter configuration. |
| Device measures incorrectly. | Configuration error or device is operated outside the application. | <ol style="list-style-type: none"> 1. Check and correct parameter configuration. 2. Observe limit values specified in the "Technical Data". |

For access

| Error | Possible causes | Remedial action |
|---|---|--|
| No write access to parameters. | Hardware write protection is enabled. | Set the write protection switch on the main electronics module to the OFF position →  126. |
| No write access to parameters. | Current user role has limited access authorization. | 1. Check user role →  58. 2. Enter correct customer-specific access code →  58. |
| Connection via HART protocol is not possible. | Missing or incorrectly installed communication resistor. | Install the communication resistor (250 Ω) correctly. Observe the maximum load →  178. |
| Connection via HART protocol is not possible. | Commubox <ul style="list-style-type: none"> ▪ Connected incorrectly. ▪ Configured incorrectly. ▪ Driver is not installed correctly. ▪ The USB port on the PC is incorrectly configured. | Observe the Commubox FXA195 HART documentation:  Technical Information TI00404F |
| Connection to the web server is not possible. | Web server is disabled. | Use the "FieldCare" or "DeviceCare" operating tool to check if the web server of the device is enabled and enable if necessary →  65. |
| | The Ethernet interface is incorrectly configured on the PC. | <ul style="list-style-type: none"> ▶ Check the properties of the Internet protocol (TCP/IP) →  61. ▶ Check the network settings with the IT manager. |
| Connection to the web server is not possible. | The IP address is incorrectly configured on the PC. | Check the IP address: 192.168.1.212 →  61 |
| Connection to the web server is not possible. | WLAN access data are incorrect. | <ul style="list-style-type: none"> ▪ Check WLAN network status. ▪ Log on to the device again using WLAN access data. ▪ Check that WLAN is enabled for the device and operating device →  61. |
| | WLAN communication is disabled. | – |
| It is not possible to connect to the web server, FieldCare or DeviceCare. | WLAN network is not available. | <ul style="list-style-type: none"> ▪ Check whether WLAN reception is available: LED on the display module lights up in blue. ▪ Check if the WLAN connection is enabled: LED on display module flashes blue. ▪ Switch on instrument function. |
| No network connection or unstable network connection. | WLAN network is weak. | <ul style="list-style-type: none"> ▪ Operating device outside of receiving range: Check the network status on the operating device. ▪ To improve network performance, use an external WLAN antenna. |
| | Parallel WLAN and Ethernet communication. | <ul style="list-style-type: none"> ▪ Check network settings. ▪ Temporarily enable only the WLAN as an interface. |
| Web browser is frozen and no further operation possible. | Data transfer is active. | Wait until data transfer or current action is finished. |
| | Connection lost | <ul style="list-style-type: none"> ▶ Check cable connection and power supply. ▶ Refresh web browser and restart if necessary. |
| The web browser contents are difficult to read or incomplete. | The web browser version used is not the best option. | <ul style="list-style-type: none"> ▶ Use correct web browser version →  60. ▶ Empty the web browser cache. ▶ Restart the web browser. |
| | Unsuitable view settings. | Change the font size/display ratio of the web browser. |
| No contents displayed in the web browser or contents incomplete. | <ul style="list-style-type: none"> ▪ JavaScript is not enabled. ▪ JavaScript cannot be enabled. | <ul style="list-style-type: none"> ▶ Enable JavaScript. ▶ Enter http://XXX.XXX.X.XX/servlet/basic.html as the IP address. |

| Error | Possible causes | Remedial action |
|--|---|--|
| Operation with FieldCare or DeviceCare not possible via CDI-RJ45 service interface (port 8000). | Firewall of the PC or network prevents communication. | Depending on the settings of the firewall used on the PC or in the network, the firewall must be disabled or adjusted for FieldCare/DeviceCare access. |
| Flashing of firmware with FieldCare or DeviceCare not possible via CDI-RJ45 service interface (port 8000 or TFTP ports). | Firewall of the PC or network prevents communication. | Depending on the settings of the firewall used on the PC or in the network, the firewall must be disabled or adjusted for FieldCare/DeviceCare access. |

11.2 Diagnostic information via light emitting diodes

11.2.1 Transmitter

Different LEDs in the transmitter provide information on the device status.

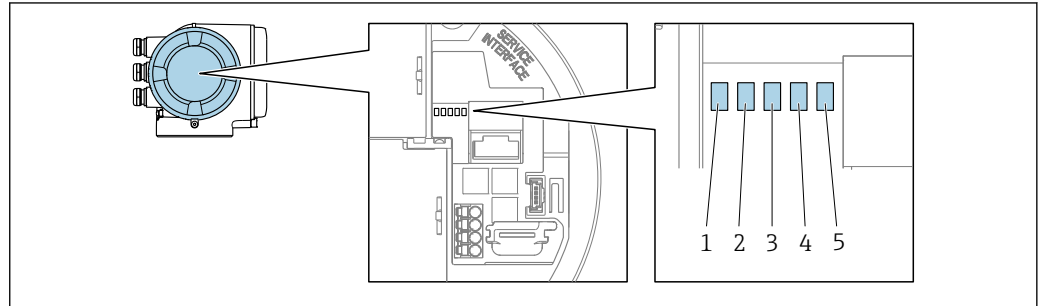

A0029629

- 1 Supply voltage
- 2 Device status
- 3 Not used
- 4 Communication
- 5 Service interface (CDI) active

| LED | Color | Meaning |
|------------------------------------|---------------------|---|
| 1 Supply voltage | Off | Supply voltage is off or too low. |
| | Green | Supply voltage is ok. |
| 2 Device status (normal operation) | Off | Firmware error |
| | Green | Device status is ok. |
| | Flashing green | Device is not configured. |
| | Red | A diagnostic event with "Alarm" diagnostic behavior has occurred. |
| | Flashing red | A diagnostic event with "Warning" diagnostic behavior has occurred. |
| 2 Device status (during start-up) | Flashes red slowly | If > 30 seconds: problem with the boot loader. |
| | Flashes red quickly | If > 30 seconds: compatibility problem when reading the firmware. |
| 3 Not used | – | – |
| 4 Communication | Off | Communication not active. |
| | White | Communication active. |
| 5 Service interface (CDI) | Off | Not connected or no connection established. |
| | Yellow | Connected and connection established. |
| | Flashing yellow | Service interface active. |

11.3 Diagnostic information on local display

11.3.1 Diagnostic message

Faults detected by the self-monitoring system of the measuring device are displayed as a diagnostic message in alternation with the operational display.

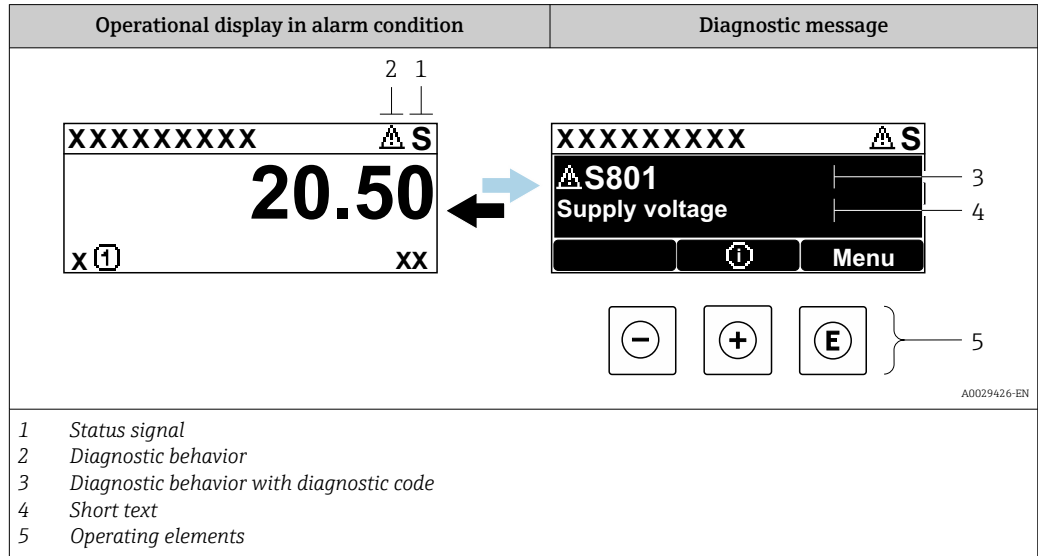

If two or more diagnostic events are pending simultaneously, only the message of the diagnostic event with the highest priority is shown.

- i** Other diagnostic events that have occurred can be displayed in the **Diagnostics** menu:
 - Via parameter → 155
 - Via submenus → 155



Status signals

The status signals provide information on the state and reliability of the device by categorizing the cause of the diagnostic information (diagnostic event).

- i** The status signals are categorized according to VDI/VDE 2650 and NAMUR Recommendation NE 107: F = Failure, C = Function Check, S = Out of Specification, M = Maintenance Required

| Symbol | Meaning |
|----------|---|
| F | Failure A device error has occurred. The measured value is no longer valid. |
| C | Function check The device is in service mode (e.g. during a simulation). |
| S | Out of specification The device is being operated: <ul style="list-style-type: none"> ▪ Outside its technical specification limits (e.g. outside the process temperature range) ▪ Outside of the configuration carried out by the user (e.g. maximum flow in parameter 20 mA value) |
| M | Maintenance required Maintenance is required. The measured value remains valid. |

Diagnostic behavior



| Symbol | Meaning |
|---|---|
|  | Alarm <ul style="list-style-type: none"> Measurement is interrupted. Signal outputs and totalizers assume the defined alarm condition. A diagnostic message is generated. |
|  | Warning <ul style="list-style-type: none"> Measurement is resumed. The signal outputs and totalizers are not affected. A diagnostic message is generated. |

Diagnostic information

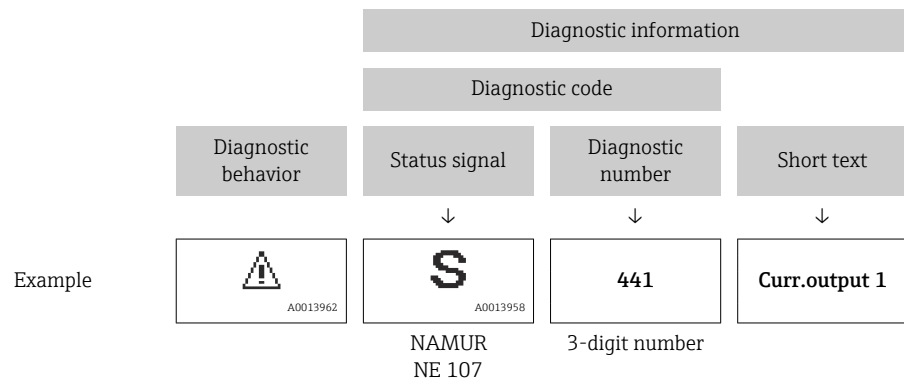
The fault can be identified using the diagnostic information. The short text helps you by providing information about the fault. In addition, the corresponding symbol for the diagnostic behavior is displayed in front of the diagnostic information on the local display.



Operating elements

| Operating key | Meaning |
|---|--|
|  | Plus key <i>In menu, submenu</i> Opens the message about the remedial measures. |
|  | Enter key <i>In menu, submenu</i> Opens the operating menu. |

11.3.2 Calling up remedial measures

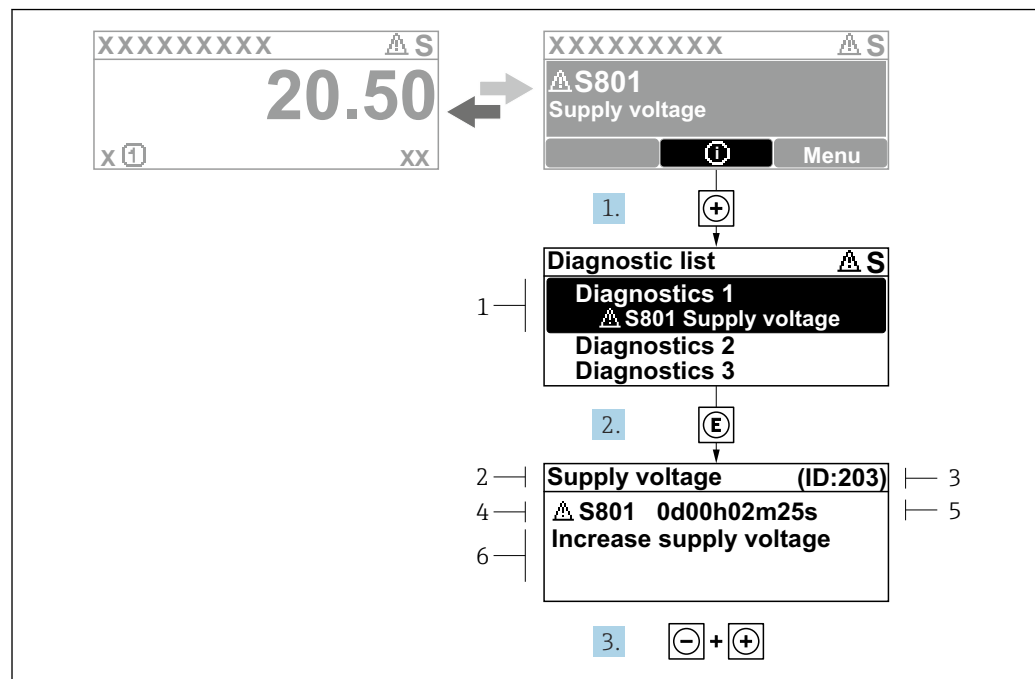

A0029431-EN

40 Message for remedial measures

- 1 Diagnostic information
- 2 Short text
- 3 Service ID
- 4 Diagnostic behavior with diagnostic code
- 5 Operation time when error occurred
- 6 Remedial measures

1. The user is in the diagnostic message.
Press \oplus (ⓘ symbol).
↳ The **Diagnostic list** submenu opens.
2. Select the desired diagnostic event with \oplus or \ominus and press E .
↳ The message about the remedial measures opens.
3. Press $\ominus + \oplus$ simultaneously.
↳ The message about the remedial measures closes.

The user is in the **Diagnostics** menu at an entry for a diagnostics event, e.g. in the **Diagnostic list** submenu or **Previous diagnostics** parameter.

1. Press E .
↳ The message for the remedial measures for the selected diagnostic event opens.
2. Press $\ominus + \oplus$ simultaneously.
↳ The message for the remedial measures closes.

11.4 Diagnostic information in the web browser

11.4.1 Diagnostic options

Any faults detected by the measuring device are displayed in the Web browser on the home page once the user has logged on.

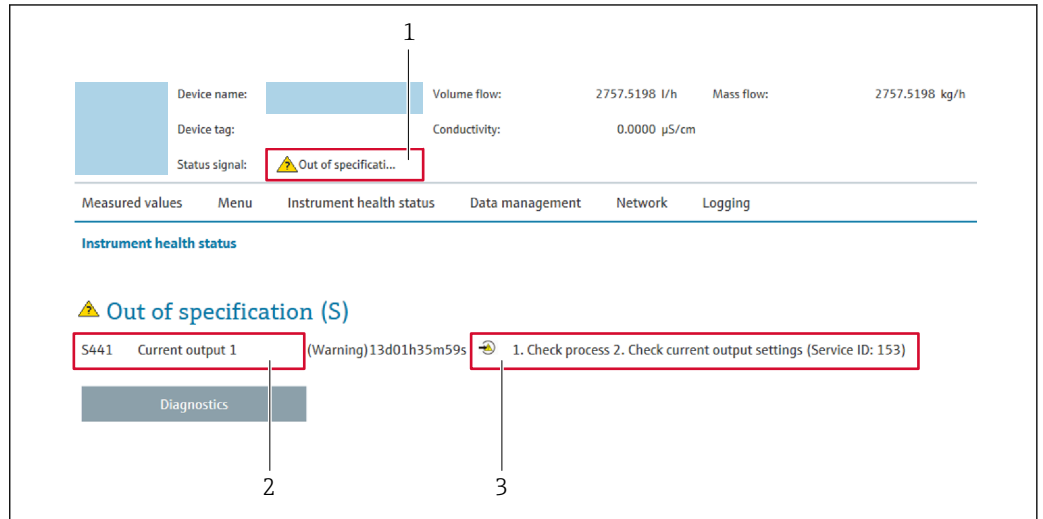

A0031056

- 1 Status area with status signal
- 2 Diagnostic information
- 3 Remedial measures with service ID

i In addition, diagnostic events which have occurred can be shown in the **Diagnostics** menu:

- Via parameter → 📄 155
- Via submenu → 📄 155

Status signals

The status signals provide information on the state and reliability of the device by categorizing the cause of the diagnostic information (diagnostic event).

| Symbol | Meaning |
|--------|---|
| | Failure A device error has occurred. The measured value is no longer valid. |
| | Function check The device is in service mode (e.g. during a simulation). |
| | Out of specification The device is being operated: <ul style="list-style-type: none"> ▪ Outside its technical specification limits (e.g. outside the process temperature range) ▪ Outside of the configuration carried out by the user (e.g. maximum flow in parameter 20 mA value) |
| | Maintenance required Maintenance is required. The measured value remains valid. |

i The status signals are categorized in accordance with VDI/VDE 2650 and NAMUR Recommendation NE 107.

11.4.2 Calling up remedy information

Remedy information is provided for every diagnostic event to ensure that problems can be rectified quickly. These measures are displayed in red along with the diagnostic event and the related diagnostic information.

11.5 Diagnostic information in FieldCare or DeviceCare

11.5.1 Diagnostic options

Any faults detected by the measuring device are displayed on the home page of the operating tool once the connection has been established.

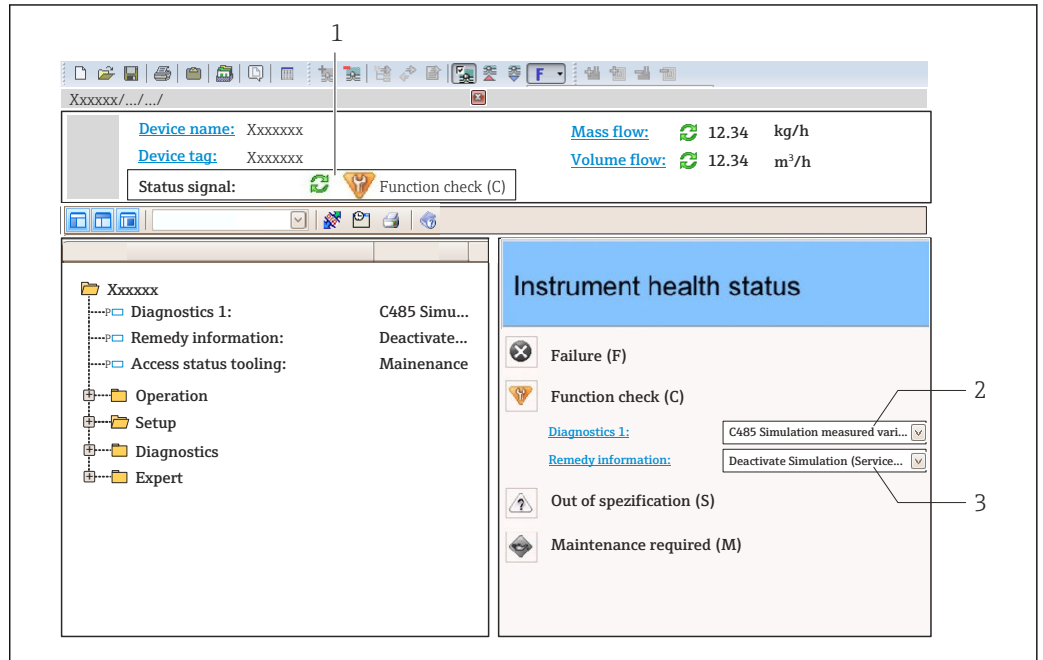

- 1 Status area with status signal → 142
- 2 Diagnostic information → 143
- 3 Remedial measures with service ID

i In addition, diagnostic events which have occurred can be shown in the **Diagnostics** menu:

- Via parameter → 155
- Via submenu → 155

Diagnostic information

The fault can be identified using the diagnostic information. The short text helps you by providing information about the fault. In addition, the corresponding symbol for the diagnostic behavior is displayed in front of the diagnostic information on the local display.

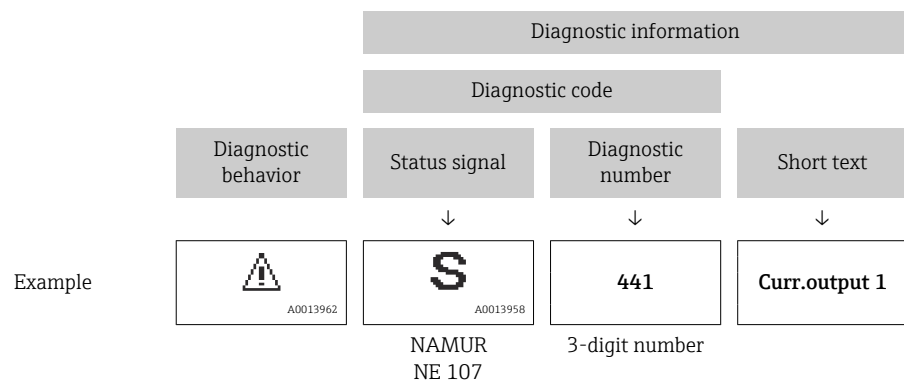

11.5.2 Calling up remedy information

Remedy information is provided for every diagnostic event to ensure that problems can be rectified quickly:

- On the home page
Remedy information is displayed in a separate field below the diagnostics information.
- In the **Diagnostics** menu
Remedy information can be called up in the working area of the user interface.

The user is in the **Diagnostics** menu.

1. Call up the desired parameter.
2. On the right in the working area, mouse over the parameter.
 - ↳ A tool tip with remedy information for the diagnostic event appears.

11.6 Adapting the diagnostic information

11.6.1 Adapting the diagnostic behavior

Each item of diagnostic information is assigned a specific diagnostic behavior at the factory. The user can change this assignment for specific diagnostic information in the **Diagnostic behavior** submenu.

Expert → System → Diagnostic handling → Diagnostic behavior

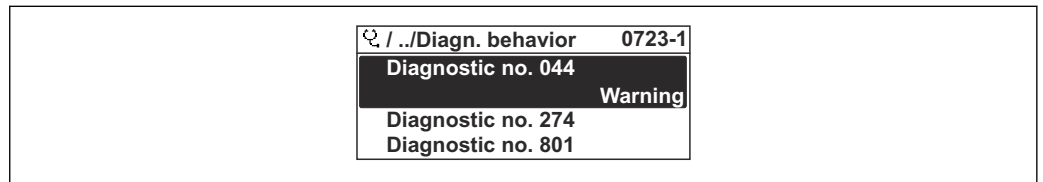

41 Taking the example of the local display

You can assign the following options to the diagnostic number as the diagnostic behavior:

| Options | Description |
|--------------------|---|
| Alarm | The device stops measurement. The signal outputs and totalizers assume the defined alarm condition. A diagnostic message is generated. The background lighting changes to red. |
| Warning | The device continues to measure. The signal outputs and totalizers are not affected. A diagnostic message is generated. |
| Logbook entry only | The device continues to measure. The diagnostic message is only displayed in the Event logbook submenu (Event list submenu) and is not displayed in alternating sequence with the operational display. |
| Off | The diagnostic event is ignored, and no diagnostic message is generated or entered. |

11.6.2 Adapting the status signal

Each item of diagnostic information is assigned a specific status signal at the factory. The user can change this assignment for specific diagnostic information in the **Diagnostic event category** submenu.

Expert → Communication → Diagnostic event category

Available status signals



Configuration as per HART 7 Specification (Condensed Status), in accordance with NAMUR NE107.

| Symbol | Meaning |
|-------------------------------------|---|
| F <small>A0013956</small> | Failure A device error has occurred. The measured value is no longer valid. |
| C <small>A0013959</small> | Function check The device is in service mode (e.g. during a simulation). |
| S <small>A0013958</small> | Out of specification The device is being operated: <ul style="list-style-type: none"> ▪ Outside its technical specification limits (e.g. outside the process temperature range) ▪ Outside of the configuration carried out by the user (e.g. maximum flow in parameter 20 mA value) |

| Symbol | Meaning |
|----------------------|---|
| M A0013957 | Maintenance required Maintenance is required. The measured value remains valid. |
| N A0023076 | Has no effect on the condensed status. |

11.7 Overview of diagnostic information

 The amount of diagnostic information and the number of measured variables affected increase if the measuring device has one or more application packages.

 In the case of some items of diagnostic information, the status signal and the diagnostic behavior can be changed. Change the diagnostic information →  149

| Diagnostic number | Short text | Remedy instructions | Status signal [from the factory] | Diagnostic behavior [from the factory] |
|---------------------------------|-------------------------------------|---|----------------------------------|--|
| Diagnostic of sensor | | | | |
| 004 | Sensor error | Change sensor | F | Alarm |
| 082 | Data storage | 1. Check module connections 2. Change electronic modules | F | Alarm |
| 083 | Memory content | 1. Restart device 2. Restore HistoROM S-DAT backup ('Device reset' parameter) 3. Replace HistoROM S-DAT | F | Alarm |
| 144 | Sensor drift | 1. Check sensor 2. Replace sensor | F | Alarm ¹⁾ |
| Diagnostic of electronic | | | | |
| 201 | Device failure | Restart device | F | Alarm |
| 242 | Software incompatible | 1. Check software 2. Flash or change main electronics module | F | Alarm |
| 252 | Modules incompatible | 1. Check electronic modules 2. Check if correct modules are available (e.g. NEx, Ex) 3. Replace electronic modules | F | Alarm |
| 252 | Modules incompatible | 1. Check if correct electronic modul is plugged 2. Replace electronic module | F | Alarm |
| 262 | Sensor electronic connection faulty | 1. Check or replace connection cable between sensor electronic module (ISEM) and main electronics 2. Check or replace ISEM or main electronics | F | Alarm |
| 270 | Main electronic failure | Change main electronic module | F | Alarm |
| 271 | Main electronic failure | 1. Restart device 2. Change main electronic module | F | Alarm |
| 272 | Main electronic failure | Restart device | F | Alarm |
| 273 | Main electronic failure | Change electronic | F | Alarm |
| 275 | I/O module 1 to n defective | Change I/O module | F | Alarm |
| 276 | I/O module 1 to n faulty | 1. Restart device 2. Change I/O module | F | Alarm |
| 281 | Electronic initialization | Firmware update active, please wait! | F | Alarm |
| 283 | Memory content | Reset device | F | Alarm |
| 283 | Memory content | Restart device | F | Alarm |
| 302 | Device verification in progress | Device verification active, please wait. | C | Warning |

| Diagnostic number | Short text | Remedy instructions | Status signal [from the factory] | Diagnostic behavior [from the factory] |
|------------------------------------|-----------------------------------|---|----------------------------------|--|
| 303 | I/O 1 to n configuration changed | 1. Apply I/O module configuration (parameter 'Apply I/O configuration') 2. Afterwards reload device description and check wiring | M | Warning |
| 311 | Electronic failure | 1. Do not reset device 2. Contact service | M | Warning |
| 332 | Writing in HistoROM backup failed | Replace user interface board Ex d/XP: replace transmitter | F | Alarm |
| 361 | I/O module 1 to n faulty | 1. Restart device 2. Check electronic modules 3. Change I/O Modul or main electronics | F | Alarm |
| 372 | Sensor electronic (ISEM) faulty | 1. Restart device 2. Check if failure recurs 3. Replace sensor electronic module (ISEM) | F | Alarm |
| 373 | Sensor electronic (ISEM) faulty | Transfer data or reset device | F | Alarm |
| 375 | I/O- 1 to n communication failed | 1. Restart device 2. Check if failure recurs 3. Replace module rack inclusive electronic modules | F | Alarm |
| 378 | Supply voltage ISEM faulty | Check supply voltage to the ISEM | F | Alarm |
| 382 | Data storage | 1. Insert T-DAT 2. Replace T-DAT | F | Alarm |
| 383 | Memory content | 1. Restart device 2. Delete T-DAT via 'Reset device' parameter 3. Replace T-DAT | F | Alarm |
| 387 | HistoROM data faulty | Contact service organization | F | Alarm |
| Diagnostic of configuration | | | | |
| 330 | Flash file invalid | 1. Update firmware of device 2. Restart device | M | Warning |
| 331 | Firmware update failed | 1. Update firmware of device 2. Restart device | F | Warning |
| 410 | Data transfer | 1. Check connection 2. Retry data transfer | F | Alarm |
| 412 | Processing download | Download active, please wait | C | Warning |
| 431 | Trim 1 to n | Carry out trim | C | Warning |
| 437 | Configuration incompatible | Restart device | F | Alarm |
| 438 | Dataset | 1. Check data set file 2. Check device configuration 3. Up- and download new configuration | M | Warning |
| 441 | Current output 1 to n | 1. Check process 2. Check current output settings | S | Warning ¹⁾ |
| 442 | Frequency output 1 to n | 1. Check process 2. Check frequency output settings | S | Warning ¹⁾ |
| 443 | Pulse output 1 to n | 1. Check process 2. Check pulse output settings | S | Warning ¹⁾ |

| Diagnostic number | Short text | Remedy instructions | Status signal [from the factory] | Diagnostic behavior [from the factory] |
|------------------------------|---|---|----------------------------------|--|
| 444 | Current input 1 to n | 1. Check process 2. Check current input settings | S | Warning ¹⁾ |
| 453 | Flow override | Deactivate flow override | C | Warning |
| 484 | Failure mode simulation | Deactivate simulation | C | Alarm |
| 485 | Measured variable simulation | Deactivate simulation | C | Warning |
| 486 | Current input 1 to n simulation | Deactivate simulation | C | Warning |
| 491 | Current output 1 to n simulation | Deactivate simulation | C | Warning |
| 492 | Simulation frequency output 1 to n | Deactivate simulation frequency output | C | Warning |
| 493 | Simulation pulse output 1 to n | Deactivate simulation pulse output | C | Warning |
| 494 | Switch output simulation 1 to n | Deactivate simulation switch output | C | Warning |
| 495 | Diagnostic event simulation | Deactivate simulation | C | Warning |
| 496 | Status input simulation | Deactivate simulation status input | C | Warning |
| 520 | I/O 1 to n hardware configuration invalid | 1. Check I/O hardware configuration 2. Replace wrong I/O module 3. Plug the module of double pulse output on correct slot | F | Alarm |
| 537 | Configuration | 1. Check IP addresses in network 2. Change IP address | F | Warning |
| 539 | Flow computer configuration incorrect | 1. Check input value (pressure, temperature) 2. Check allowed values of the medium properties | S | Alarm |
| 594 | Relay output simulation | Deactivate simulation switch output | C | Warning |
| Diagnostic of process | | | | |
| 803 | Current loop | 1. Check wiring 2. Change I/O module | F | Alarm |
| 832 | Electronic temperature too high | Reduce ambient temperature | S | Warning ¹⁾ |
| 833 | Electronic temperature too low | Increase ambient temperature | S | Warning ¹⁾ |
| 834 | Process temperature too high | Reduce process temperature | S | Warning ¹⁾ |
| 835 | Process temperature too low | Increase process temperature | S | Warning ¹⁾ |
| 842 | Process limit | Low flow cut off active! 1. Check low flow cut off configuration | S | Warning ¹⁾ |
| 882 | Input signal | 1. Check input configuration 2. Check external device or process conditions | F | Alarm |
| 941 | Flow velocity too high | 1. Check process cond. 2. Increase system pressure | S | Alarm |
| 961 | Delta temperature | Check flow rate | S | Alarm |





| Diagnostic number | Short text | Remedy instructions | Status signal [from the factory] | Diagnostic behavior [from the factory] |
|-------------------|-----------------------------------|---|----------------------------------|--|
| 976 | Mass flow out of calibrated range | 1. Check process cond. 2. Increase system pressure | S | Warning ¹⁾ |
| 977 | Reverse flow detected | Check flow direction | S | Warning ¹⁾ |
| 979 | Unstable process conditions | 1. Check process cond. 2. Increase system pressure | S | Warning ¹⁾ |



1) Diagnostic behavior can be changed.

11.8 Pending diagnostic events

The **Diagnostics** menu allows the user to view the current diagnostic event and the previous diagnostic event separately.

 To call up the measures to rectify a diagnostic event:

- Via local display →  144
- Via web browser →  146
- Via "FieldCare" operating tool →  148
- Via "DeviceCare" operating tool →  148

 Other pending diagnostic events can be displayed in the **Diagnostic list** submenu →  155

Navigation

"Diagnostics" menu

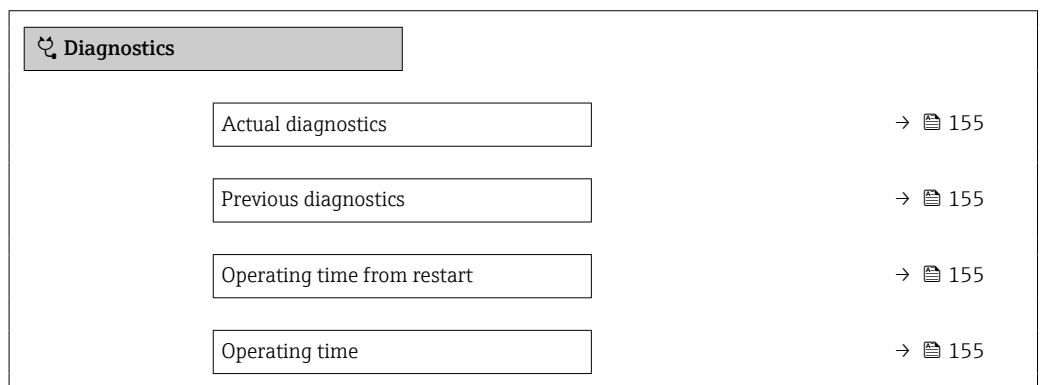

Parameter overview with brief description

| Parameter | Prerequisite | Description | User interface |
|-----------------------------|--|--|--|
| Actual diagnostics | A diagnostic event has occurred. | Shows the current occurred diagnostic event along with its diagnostic information.  If two or more messages occur simultaneously, the message with the highest priority is shown on the display. | Symbol for diagnostic behavior, diagnostic code and short message. |
| Previous diagnostics | Two diagnostic events have already occurred. | Shows the diagnostic event that occurred prior to the current diagnostic event along with its diagnostic information. | Symbol for diagnostic behavior, diagnostic code and short message. |
| Operating time from restart | – | Shows the time the device has been in operation since the last device restart. | Days (d), hours (h), minutes (m) and seconds (s) |
| Operating time | – | Indicates how long the device has been in operation. | Days (d), hours (h), minutes (m) and seconds (s) |

11.9 Diagnostic list

Up to 5 currently pending diagnostic events can be displayed in the **Diagnostic list** submenu along with the associated diagnostic information. If more than 5 diagnostic events are pending, the events with the highest priority are shown on the display.



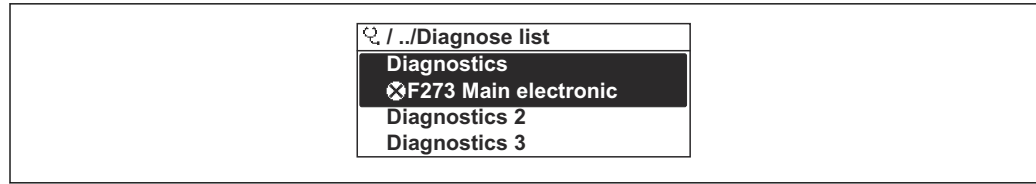

Navigation path

Diagnostics → Diagnostic list



A0014006-EN

 42 Taking the example of the local display

-  To call up the measures to rectify a diagnostic event:
- Via local display →  144
 - Via web browser →  146
 - Via "FieldCare" operating tool →  148
 - Via "DeviceCare" operating tool →  148

11.10 Event logbook

11.10.1 Reading out the event logbook

A chronological overview of the event messages that have occurred is provided in the **Events list** submenu.

Navigation path

Diagnostics menu → **Event logbook** submenu → Event list

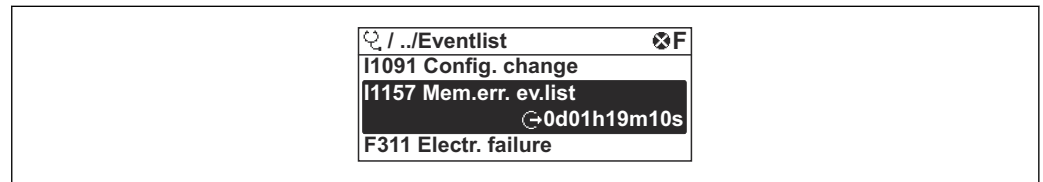

43 Taking the example of the local display

- A maximum of 20 event messages can be displayed in chronological order.
- If the **Extended HistoROM** application package (order option) is enabled in the device, the event list can contain up to 100 entries .

The event history includes entries for:

- Diagnostic events → 151
- Information events → 158

In addition to the operation time of its occurrence, each event is also assigned a symbol that indicates whether the event has occurred or is ended:

- Diagnostic event
 - ⌚: Occurrence of the event
 - ⌚: End of the event
- Information event
 - ⌚: Occurrence of the event

i To call up the measures to rectify a diagnostic event:

- Via local display → 144
- Via web browser → 146
- Via "FieldCare" operating tool → 148
- Via "DeviceCare" operating tool → 148

i For filtering the displayed event messages → 157

11.10.2 Filtering the event logbook

Using the **Filter options** parameter you can define which category of event message is displayed in the **Events list** submenu.

Navigation path

Diagnostics → **Event logbook** → **Filter options**

Filter categories

- All
- Failure (F)
- Function check (C)
- Out of specification (S)
- Maintenance required (M)
- Information (I)

11.10.3 Overview of information events

Unlike a diagnostic event, an information event is displayed in the event logbook only and not in the diagnostic list.

| Info number | Info name |
|-------------|--|
| I1000 | ----- (Device ok) |
| I1079 | Sensor changed |
| I1089 | Power on |
| I1090 | Configuration reset |
| I1091 | Configuration changed |
| I1092 | HistoROM backup deleted |
| I1137 | Electronic changed |
| I1151 | History reset |
| I1155 | Reset electronic temperature |
| I1156 | Memory error trend |
| I1157 | Memory error event list |
| I1221 | Zero point adjust failure |
| I1222 | Zero point adjustment ok |
| I1256 | Display: access status changed |
| I1264 | Safety sequence aborted |
| I1278 | I/O module restarted |
| I1335 | Firmware changed |
| I1361 | Web server: login failed |
| I1397 | Fieldbus: access status changed |
| I1398 | CDI: access status changed |
| I1444 | Device verification passed |
| I1445 | Device verification failed |
| I1457 | Measurement error verification failed |
| I1459 | I/O module verification failed |
| I1461 | Sensor verification failed |
| I1462 | Sensor electronic module verific. failed |
| I1512 | Download started |
| I1513 | Download finished |
| I1514 | Upload started |
| I1515 | Upload finished |
| I1554 | Safety sequence started |
| I1555 | Safety sequence confirmed |
| I1556 | Safety mode off |
| I1618 | I/O module 2 replaced |
| I1619 | I/O module 3 replaced |
| I1621 | I/O module 4 replaced |
| I1622 | Calibration changed |
| I1624 | Reset all totalizers |
| I1625 | Write protection activated |

| Info number | Info name |
|-------------|---|
| I1626 | Write protection deactivated |
| I1627 | Web server: login successful |
| I1628 | Display: login successful |
| I1629 | CDI: login successful |
| I1631 | Web server access changed |
| I1632 | Display: login failed |
| I1633 | CDI: login failed |
| I1634 | Reset to factory settings |
| I1635 | Reset to delivery settings |
| I1639 | Max. switch cycles number reached |
| I1649 | Hardware write protection activated |
| I1650 | Hardware write protection deactivated |
| I1712 | New flash file received |
| I1725 | Sensor electronic module (ISEM) changed |
| I1726 | Configuration backup failed |

11.11 Resetting the measuring device

The entire device configuration or some of the configuration can be reset to a defined state with the **Device reset** parameter (→  115).

11.11.1 Function range of "Device reset" parameter

| Options | Description |
|----------------------|---|
| Cancel | No action is executed and the user exits the parameter. |
| To delivery settings | Every parameter for which a customer-specific default setting was ordered is reset to the customer-specific value. All other parameters are reset to the factory setting. |
| Restart device | The restart resets every parameter with data stored in volatile memory (RAM) to the factory setting (e.g. measured value data). The device configuration remains unchanged. |
| Restore S-DAT backup | Restores the data that is saved on the S-DAT. Additional information: This function can be used to resolve the memory issue "083 Memory content inconsistent" or to restore the S-DAT data when a new S-DAT has been installed.  This option is displayed only in an alarm condition. |

11.12 Device information

The **Device information** submenu contains all parameters that display different information for device identification.

Navigation



"Diagnostics" menu → Device information

▶ **Device information**



| | |
|-----------------------|---------|
| Device tag | → ⓘ 161 |
| Serial number | → ⓘ 161 |
| Firmware version | → ⓘ 161 |
| Device name | → ⓘ 161 |
| Order code | → ⓘ 162 |
| Extended order code 1 | → ⓘ 162 |
| Extended order code 2 | → ⓘ 162 |
| Extended order code 3 | → ⓘ 162 |
| ENP version | → ⓘ 162 |
| Device revision | → ⓘ 162 |
| Device ID | → ⓘ 162 |
| Device type | → ⓘ 162 |
| Manufacturer ID | → ⓘ 162 |

Parameter overview with brief description

| Parameter | Description | User interface | Factory setting |
|------------------|--|--|-----------------|
| Device tag | Shows name of measuring point. | Max. 32 characters, such as letters, numbers or special characters (e.g. @, %, /). | - |
| Serial number | Shows the serial number of the measuring device. | Max. 11-digit character string comprising letters and numbers. | - |
| Firmware version | Shows the device firmware version installed. | Character string in the format xx.yy.zz | - |
| Device name | Shows the name of the transmitter. The name can be found on the nameplate of the transmitter. | Character string comprising numbers, letters and special characters | - |

| Parameter | Description | User interface | Factory setting |
|-----------------------|--|---|-----------------------------|
| Manufacturer | Displays the manufacturer. | Character string comprising numbers, letters and special characters | – |
| Order code | Shows the device order code. | Character string composed of letters, numbers and certain punctuation marks (e.g. /). | – |
| Extended order code 1 | Shows the 1st part of the extended order code. | Character string | – |
| Extended order code 2 | Shows the 2nd part of the extended order code.  The extended order code can also be found on the nameplate of the sensor and transmitter in the "Ext. ord. cd." field. | Character string | – |
| Extended order code 3 | Shows the 3rd part of the extended order code.  The extended order code can also be found on the nameplate of the sensor and transmitter in the "Ext. ord. cd." field. | Character string | – |
| ENP version | Shows the version of the electronic nameplate (ENP). | Character string | – |
| Device revision | Shows the device revision with which the device is registered with the HART Communication Foundation. | 2-digit hexadecimal number | 0x1 |
| Device ID | Shows the device ID for identifying the device in a HART network. | 6-digit hexadecimal number | – |
| Device type | Shows the device type with which the measuring device is registered with the HART Communication Foundation. | 2-digit hexadecimal number | 0x1160 (for t-mass 300/500) |
| Manufacturer ID | Shows the manufacturer ID device is registered with the HART Communication Foundation. | 2-digit hexadecimal number | 0x11 (for Endress+Hauser) |

11.13 Firmware history

-  It is possible to flash the firmware to the current version or the previous version using the service interface.
-  For the compatibility of the firmware version with the previous version, the installed device description files and operating tools, observe the information about the device in the "Manufacturer's information" document.
-  The manufacturer's information is available:
 - In the Download Area of the Endress+Hauser web site: www.endress.com → Downloads
 - Specify the following details:
 - Text search: Manufacturer's information
 - Media type: Documentation – Technical Documentation

12 Maintenance

12.1 Maintenance tasks

No special maintenance work is required.

12.1.1 Exterior cleaning

When cleaning the exterior of measuring devices, always use cleaning agents that do not attack the surface of the housing or the seals.

12.1.2 Sensing element cleaning

Cleaning the sensing element

The measuring device can be removed for cleaning.

Use key size 36 mm (1.42 in) to remove the sensor.

⚠ WARNING

Injury from measuring device being ejected!

- ▶ Ensure the system is depressurized before commencing the cleaning work.

NOTICE

Damage to the sensing element!

- ▶ Make sure the sensing elements do not hit against anything.

NOTICE

The use of unsuitable equipment or cleaning liquids can damage the measuring device.

- ▶ Do not use pigs to clean the pipe.
- ▶ Use an oil-free cleaning agent that does not form a film to clean the sensor.

NOTICE

Damage to the sealing surfaces!

- ▶ Make sure the sealing surfaces do not hit against anything.

1. Ensure the system is unpressurized.

2. Release the compression fitting of the measuring device.

3. Carefully remove the measuring device from the process pipe.



4. **NOTICE**

The protective guard protects the sensing element from damage!

- ▶ Do not remove the protective guard.

Gently clean the sensing elements using a soft brush.

5. Carefully insert the measuring device into the process pipe.

↳ Make sure the measuring device is aligned correctly →  16,  29.

6. **For PEEK ferrules:**

Tighten compression fitting with 1 turn.

7. **For metal ferrules:**

Tighten compression fitting with a ¼ turn.

i Increase the pressure in the piping system and check for leaks once the desired pressure is reached.

12.1.3 Recalibration

The long-term stability of a measuring device depends on the integrity of the sensor, among other things. Impurities can also cause a coating to form on the sensor, which can cause a change in the measuring signal. Therefore, if the sensor is used in applications in which impurities (such as oil residue or dust) can occur, it is advisable to check the sensor for contamination at regular intervals and clean it if necessary (see →  164). The intervals depend on the type, condition and extent of the contamination.

Process conditions such as thermal shocks or constant variations in temperatures can create the conditions in which the measuring signal drifts over time. A recalibration can rectify these undesired changes in the measuring signal and restore the original measuring state.

Determining the recalibration intervals:

- In the event of critical measurements and in order to determine the recalibration intervals, a calibration check should be performed once a year. The next recalibration can then be scheduled earlier or later depending on the results of these checks.
- A recalibration every three years is recommended for non-critical applications or for use in clean and dry gases.
- Heartbeat Verification can be used to help determine when a recalibration should be performed. By performing verifications regularly, it is possible to compare the verification results with the initial values determined at the factory. If these values deviate from one another, this can indicate that the device needs to be recalibrated.

12.2 Measuring and test equipment

Endress+Hauser offers a wide variety of measuring and test equipment, such as W@M or device tests.

 Your Endress+Hauser Sales Center can provide detailed information on the services.

List of some of the measuring and testing equipment: →  171

12.3 Endress+Hauser services

Endress+Hauser offers a wide variety of services for maintenance such as recalibration, maintenance service or device tests.

 Your Endress+Hauser Sales Center can provide detailed information on the services.

13 Repair

13.1 General information

13.1.1 Repair and conversion concept

The Endress+Hauser repair and conversion concept provides for the following:

- The measuring devices have a modular design.
- Spare parts are grouped into logical kits with the associated Installation Instructions.
- Repairs are carried out by Endress+Hauser Service or by appropriately trained customers.
- Certified devices can only be converted to other certified devices by Endress+Hauser Service or at the factory.

13.1.2 Notes for repair and conversion



For repair and modification of a measuring device, observe the following notes:

- ▶ Use only original Endress+Hauser spare parts.
- ▶ Carry out the repair according to the Installation Instructions.
- ▶ Observe the applicable standards, federal/national regulations, Ex documentation (XA) and certificates.
- ▶ Document every repair and each conversion and enter them into the *W@M* life cycle management database and Netilion Analytics.

13.2 Spare parts

Device Viewer (www.endress.com/deviceviewer):

All the spare parts for the measuring device, along with the order code, are listed here and can be ordered. If available, users can also download the associated Installation Instructions.

-  Measuring device serial number:
 - Is located on the nameplate of the device.
 - Can be read out via the **Serial number** parameter (→  161) in the **Device information** submenu.

13.3 Endress+Hauser services

Endress+Hauser offers a wide range of services.

-  Your Endress+Hauser Sales Center can provide detailed information on the services.

13.4 Return

The requirements for safe device return can vary depending on the device type and national legislation.

1. Refer to the web page for information:
<http://www.endress.com/support/return-material>
 - ↳ Select the region.
2. Return the device if repairs or a factory calibration are required, or if the wrong device was ordered or delivered.

13.5 Disposal



If required by the Directive 2012/19/EU on waste electrical and electronic equipment (WEEE), the product is marked with the depicted symbol in order to minimize the disposal of WEEE as unsorted municipal waste. Do not dispose of products bearing this marking as unsorted municipal waste. Instead, return them to the manufacturer for disposal under the applicable conditions.

13.5.1 Removing the measuring device

1. Switch off the device.

⚠ WARNING

Danger to persons from process conditions!

- ▶ Beware of hazardous process conditions such as pressure in the measuring device, high temperatures or aggressive media.
2. Carry out the mounting and connection steps from the "Mounting the measuring device" and "Connecting the measuring device" sections in reverse order. Observe the safety instructions.

13.5.2 Disposing of the measuring device

⚠ WARNING

Danger to personnel and environment from fluids that are hazardous to health.

- ▶ Ensure that the measuring device and all cavities are free of fluid residues that are hazardous to health or the environment, e.g. substances that have permeated into crevices or diffused through plastic.

Observe the following notes during disposal:











- ▶ Observe valid federal/national regulations.
- ▶ Ensure proper separation and reuse of the device components.

14 Accessories









Various accessories, which can be ordered with the device or subsequently from Endress+Hauser, are available for the device. Detailed information on the order code in question is available from your local Endress+Hauser sales center or on the product page of the Endress+Hauser website: www.endress.com.

14.1 Device-specific accessories







14.1.1 For the transmitter

| Accessories | Description |
|--|--|
| Proline 300 transmitter | <p>Transmitter for replacement or storage. Use the order code to define the following specifications:</p> <ul style="list-style-type: none"> ▪ Approvals ▪ Output ▪ Input ▪ Display/operation ▪ Housing ▪ Software <p> Order code: 6X3BXX</p> <p> Installation Instructions EA01286D</p> |
| Remote display and operating module DKX001 | <ul style="list-style-type: none"> ▪ If ordered directly with the measuring device: Order code for "Display; operation", option O "Remote display 4-line, illuminated; 10 m (30 ft) cable; touch control" ▪ If ordered separately: <ul style="list-style-type: none"> ▪ Measuring device: order code for "Display; operation", option M "W/o, prepared for remote display" ▪ DKX001: Via the separate product structure DKX001 ▪ If ordered subsequently: DKX001: Via the separate product structure DKX001 <p>Mounting bracket for DKX001</p> <ul style="list-style-type: none"> ▪ If ordered directly: order code for "Accessory enclosed", option RA "Mounting bracket, pipe 1/2" ▪ If ordered subsequently: order number: 71340960 <p>Connecting cable (replacement cable) Via the separate product structure: DKX002</p> <p> Further information on display and operating module DKX001 →  194.</p> <p> Special Documentation SD01763D</p> |
| External WLAN antenna | <p>External WLAN antenna with 1.5 m (59.1 in) connecting cable and two angle brackets. Order code for "Accessory enclosed", option P8 "Wireless antenna wide area".</p> <p> <ul style="list-style-type: none"> ▪ The external WLAN antenna is not suitable for use in hygienic applications. ▪ Additional information regarding the WLAN interface →  68. </p> <p> Order number: 71351317</p> <p> Installation Instructions EA01238D</p> |
| Weather protection cover | <p>Is used to protect the measuring device from the effects of the weather: e.g. rainwater, excess heating from direct sunlight.</p> <p> Order number: 71343505</p> <p> Installation Instructions EA01160D</p> |



14.1.2 For the sensor

| Accessories | Description |
|-----------------------------|--|
| Mounting boss | <p>Order code for "Accessory enclosed"</p> <ul style="list-style-type: none"> ▪ Option PC "Mounting boss, G1" ▪ Option PD "Mounting boss, 1" NPT" ▪ Option PE "Mounting boss, G$\frac{3}{4}$" ▪ Option PF "Mounting boss, $\frac{3}{4}$" NPT" <p> Can be ordered separately: order code DK6MB</p> |
| Cold tap (ambient pressure) | <p>Order code for "Accessory enclosed"</p> <ul style="list-style-type: none"> ▪ Option PR "Cold tap G1, ambient pressure" ▪ Option PS "Cold tap 1" NPT, ambient pressure" ▪ Option PT "Cold tap G$\frac{3}{4}$", ambient pressure" ▪ Option PU "Cold tap $\frac{3}{4}$" NPT, ambient pressure" <p> Can be ordered separately: order code DK6ML</p> |
| Hot tap (low pressure) | <p>Order code for "Accessory enclosed"</p> <ul style="list-style-type: none"> ▪ Option PG "Hot tap G1, low pressure max. 4.5 bar/65 psig" ▪ Option PH "Hot tap 1" NPT, low pressure max. 4.5 bar/65 psig" ▪ Option PK "Hot tap G$\frac{3}{4}$", low pressure max. 4.5 bar/65 psig" ▪ Option PL "Hot tap $\frac{3}{4}$" NPT, low pressure max. 4.5 bar/65 psig" <p> Mounting set contains mounting boss (process connection), sensor connection with safety chain and ball valve. To insert or remove the sensor at process pressures up to max. 4.5 barg (65 psi).</p> <p> If the accessory is ordered separately, individual combinations can be selected. Order code DK6003</p> |
| Hot tap (medium pressure) | <p>Order code for "Accessory enclosed"</p> <ul style="list-style-type: none"> ▪ Option PI "Hot tap G1, medium pressure max. 16 bar/230 psig" ▪ Option PJ "Hot tap 1" NPT, medium pressure max. 16 bar/230 psig" ▪ Option PM "Hot tap G$\frac{3}{4}$", medium pressure max. 16 bar/230 psig" ▪ Option PN "Hot tap $\frac{3}{4}$" NPT, medium pressure max. 16 bar/230 psig" <p> Mounting set contains mounting boss (process connection), sensor connection, ball valve and extractor assembly. To insert or remove the sensor at process pressures up to max. 16 barg (230 psi).</p> <p> If the accessory is ordered separately, individual combinations can be selected. Order code DK6003</p> |
| Flow conditioner | <p> Can be ordered separately: order code DK6004</p> <p>Available for the following pipe diameters:</p> <ul style="list-style-type: none"> ▪ DN 80 (3") ▪ DN 100 (4") ▪ DN 150 (6") ▪ DN 200 (8") ▪ DN 250 (10") ▪ DN 300 (12") <p>Available for the following process connections:</p> <ul style="list-style-type: none"> ▪ PN10, EN1092-1 ▪ PN16, EN1092-1 ▪ PN25, EN1092-1 ▪ PN40, EN1092-1 ▪ Cl.150, ASME B16.5 ▪ Cl.300, ASME B16.5 ▪ 10K, JIS B2220 ▪ 20K, JIS B2220 <p> Screws and seals are not included in the delivery.</p> |





14.2 Communication-specific accessories

| Accessories | Description |
|------------------------------|--|
| Commubox FXA195 HART | For intrinsically safe HART communication with FieldCare via the USB port.  Technical Information TI00404F |
| HART Loop Converter HMX50 | Is used to evaluate and convert dynamic HART process variables to analog current signals or limit values.  <ul style="list-style-type: none"> ▪ Technical Information TI00429F ▪ Operating Instructions BA00371F |
| Fieldgate FXA42 | Transmission of the measured values of connected 4 to 20 mA analog measuring devices, as well as digital measuring devices  <ul style="list-style-type: none"> ▪ Technical Information TI01297S ▪ Operating Instructions BA01778S ▪ Product page: www.endress.com/fxa42 |
| Field Xpert SMT50 | The Field Xpert SMT70 tablet PC for device configuration enables mobile plant asset management in non-hazardous areas. It is suitable for commissioning and maintenance staff to manage field instruments with a digital communication interface and to record progress. This tablet PC is designed as an all-in-one solution with a preinstalled driver library and is an easy-to-use, touch-sensitive tool which can be used to manage field instruments throughout their entire life cycle.  <ul style="list-style-type: none"> ▪ Technical Information TI01342S ▪ Operating Instructions BA01709S ▪ Product page: www.endress.com/smt50 |
| Field Xpert SMT70 | The Field Xpert SMT70 tablet PC for device configuration enables mobile plant asset management in hazardous and non-hazardous areas. It is suitable for commissioning and maintenance staff to manage field instruments with a digital communication interface and to record progress. This tablet PC is designed as an all-in-one solution with a preinstalled driver library and is an easy-to-use, touch-sensitive tool which can be used to manage field instruments throughout their entire life cycle.  <ul style="list-style-type: none"> ▪ Technical Information TI01342S ▪ Operating Instructions BA01709S ▪ Product page: www.endress.com/smt70 |
| Field Xpert SMT77 | The Field Xpert SMT77 tablet PC for device configuration enables mobile plant asset management in areas categorized as Ex Zone 1.  <ul style="list-style-type: none"> ▪ Technical Information TI01418S ▪ Operating Instructions BA01923S ▪ Product page: www.endress.com/smt77 |

14.3 Service-specific accessories

| Accessories | Description |
|-------------|--|
| Applicator | <p>Software for selecting and sizing Endress+Hauser measuring devices:</p> <ul style="list-style-type: none"> Choice of measuring devices for industrial requirements Calculation of all the necessary data for identifying the optimum flowmeter: e.g. nominal diameter, pressure loss, flow velocity and accuracy. Graphic illustration of the calculation results Determination of the partial order code, administration, documentation and access to all project-related data and parameters over the entire life cycle of a project. <p>Applicator is available:</p> <ul style="list-style-type: none"> Via the Internet: https://portal.endress.com/webapp/applicator As a downloadable DVD for local PC installation. |
| W@M | <p>W@M Life Cycle Management</p> <p>Improved productivity with information at your fingertips. Data relevant to a plant and its components is generated from the first stages of planning and during the asset's complete life cycle.</p> <p>W@M Life Cycle Management is an open and flexible information platform with online and on-site tools. Instant access for your staff to current, in-depth data shortens your plant's engineering time, speeds up procurement processes and increases plant uptime.</p> <p>Combined with the right services, W@M Life Cycle Management boosts productivity in every phase. For more information, see: www.endress.com/lifecyclemanagement</p> |
| FieldCare | <p>FDT-based plant asset management tool from Endress+Hauser.</p> <p>It can configure all smart field units in your system and helps you manage them. By using the status information, it is also a simple but effective way of checking their status and condition.</p> <p> Operating Instructions BA00027S and BA00059S</p> |
| DeviceCare | <p>Tool to connect and configure Endress+Hauser field devices.</p> <p> Innovation brochure IN01047S</p> |

14.4 System components

| Accessories | Description |
|----------------------------------|--|
| Memograph M graphic data manager | <p>The Memograph M graphic data manager provides information on all the relevant measured variables. Measured values are recorded correctly, limit values are monitored and measuring points analyzed. The data are stored in the 256 MB internal memory and also on a SD card or USB stick.</p> <p> <ul style="list-style-type: none"> Technical Information TI00133R Operating Instructions BA00247R </p> |
| Ceraphant PTC31B | <p>The pressure transmitter for measuring the absolute and gauge pressure in gases, steam, liquids and dusts. It can be used to read in the operating pressure value.</p> <p> <ul style="list-style-type: none"> Technical Information TI01130P Operating Instructions BA01270P </p> |
| Cerabar PMC21 | <p>The pressure transmitter for measuring the absolute and gauge pressure in gases, steam, liquids and dusts. It can be used to read in the operating pressure value.</p> <p> <ul style="list-style-type: none"> Technical Information TI01133P Operating Instructions BA01271P </p> |
| Cerabar S PMC71 | <p>The pressure transmitter for measuring the absolute and gauge pressure of gases, steam and liquids. It can be used to read in the operating pressure value.</p> <p> <ul style="list-style-type: none"> Technical Information TI00383P Operating Instructions BA00271P </p> |

15 Technical data

15.1 Application

The measuring device is intended only for the flow measurement of gases.

To ensure that the device remains in proper operating condition for its service life, use the measuring device only for media against which the process-wetted materials are sufficiently resistant.

15.2 Function and system design

| | |
|---------------------|---|
| Measuring principle | Mass flow measurement based on thermal measuring principle. |
|---------------------|---|

| | |
|------------------|--|
| Measuring system | <p>The device consists of a transmitter and a sensor.</p> <p>The device is available as a compact version: The transmitter and sensor form a mechanical unit.</p> <p>Information on the structure of the device →  14</p> |
|------------------|--|

15.3 Input

Measured variable

Measured process variables

- Mass flow
- Temperature

Calculated process variables

- Corrected volume flow
- Volume flow
- FAD volume flow
- Flow velocity
- Calorific value
- 2nd temperature heat difference
- Heat flow
- Energy flow
- Density

Process variables available for order

Order code for "Sensor version":

- Option SB "Bidirectional" measures the flow in both directions (»positive« and »negative« flow) and totalizes the flow in both directions. The device is calibrated in both directions.
- Option SC "Reverse flow detection" only measures the flow in the positive direction. The reverse flow is detected by the device but is not totalized. The device is only calibrated in the positive forward flow direction.

Order code for "Application package":

Option EV "Second gas group" enables the configuration of two different standard gases/gas mixtures in the device and allows the user to switch from one gas group to another using the status input or (if available) via bus communication.

Measuring range

The available measuring range depends on the choice of gas and size of the pipe. Each measuring device is calibrated individually with air under reference operating conditions. No recalibration is required in the case of customer-specific gases, as the device's Gas Engine functionality converts from air to these gases.

The measuring ranges calibrated for air are indicated in the following section. For information on other gases and process conditions, contact your sales organization or use the Applicator selection software.

SI units

- Order code for "Sensor version; sensor; insertion tube", option SA "Unidirectional; stainless steel; stainless steel"
- Order code for "Sensor version; sensor; insertion tube", option HA "Unidirectional; Alloy; stainless steel"

| DN [mm] | Full scale value [kg/h] (Air, 20°C, 1.013 bar a) | | Full scale value [Nm ³ /h] (Air, 0°C, 1.013 bar a) | |
|------------|---|---------|--|---------|
| | Minimum | Maximum | Minimum | Maximum |
| 80 | 21 | 2 086 | 16 | 1 613 |
| 100 | 33 | 3 260 | 25 | 2 521 |
| 150 | 73 | 7 335 | 57 | 5 672 |
| 200 | 130 | 13 040 | 101 | 10 084 |
| 250 | 204 | 20 375 | 158 | 15 757 |

| DN [mm] | Full scale value [kg/h] (Air, 20°C, 1.013 bar a) | | Full scale value [Nm ³ /h] (Air, 0°C, 1.013 bar a) | |
|------------|---|---------|--|---------|
| | Minimum | Maximum | Minimum | Maximum |
| 300 | 293 | 29340 | 227 | 22689 |
| 400 | 522 | 52160 | 403 | 40337 |
| 500 | 815 | 81500 | 630 | 63026 |
| 600 | 1174 | 117360 | 908 | 90758 |
| 700 | 1597 | 159740 | 1235 | 123531 |
| 1000 | 3260 | 326000 | 2521 | 252105 |
| 1500 | 7335 | 733501 | 5672 | 567236 |

- Order code for "Sensor version; sensor; insertion tube:", option SB "Bidirectional; stainless steel; stainless steel"
- Order code for "Sensor version; sensor; insertion tube:", option SC "Reverse flow detection; stainless steel; stainless steel"

| DN [mm] | Full scale value [kg/h] (Air, 20°C, 1.013 bar a) | | Full scale value [Nm ³ /h] (Air, 0°C, 1.013 bar a) | |
|------------|---|---------|--|---------|
| | Minimum | Maximum | Minimum | Maximum |
| 80 | 13 | 1310 | 10 | 1012 |
| 100 | 23 | 2310 | 17 | 1786 |
| 150 | 47 | 4750 | 36 | 3673 |
| 200 | 84 | 8475 | 65 | 6553 |
| 250 | 132 | 13250 | 102 | 10246 |
| 300 | 190 | 19000 | 146 | 14692 |
| 400 | 337 | 33750 | 260 | 26099 |
| 500 | 530 | 53000 | 409 | 40986 |
| 600 | 762 | 76250 | 589 | 58966 |
| 700 | 1038 | 103820 | 802 | 80286 |
| 1000 | 2119 | 211900 | 1638 | 163868 |
| 1500 | 4767 | 476750 | 3686 | 368683 |

US units

- Order code for "Sensor version; sensor; insertion tube", option SA "Unidirectional; stainless steel; stainless steel"
- Order code for "Sensor version; sensor; insertion tube", option HA "Unidirectional; Alloy; stainless steel"

| DN [in] | Full scale value [lb/h] (Air, 68°F, 14.7 psi a) | | Full scale value [SCFM] (Air, 59°F, 14.7 psi a) | |
|------------|--|---------|--|---------|
| | Minimum | Maximum | Minimum | Maximum |
| 3 | 42 | 4173 | 9 | 909 |
| 4 | 74 | 7419 | 16 | 1616 |
| 6 | 167 | 16693 | 36 | 3636 |
| 8 | 297 | 29677 | 65 | 6464 |
| 10 | 464 | 46371 | 101 | 10100 |
| 12 | 668 | 66774 | 145 | 14544 |

| DN [in] | Full scale value [lb/h] (Air, 68°F, 14.7 psi a) | | Full scale value [SCFM] (Air, 59°F, 14.7 psi a) | |
|------------|--|-----------|--|---------|
| | Minimum | Maximum | Minimum | Maximum |
| 16 | 1 187 | 118 709 | 259 | 25 856 |
| 20 | 1 855 | 185 482 | 404 | 40 400 |
| 24 | 2 671 | 267 094 | 582 | 58 176 |
| 28 | 3 635 | 363 545 | 792 | 79 184 |
| 40 | 7 419 | 741 929 | 1 616 | 161 600 |
| 60 | 16 693 | 1 669 340 | 3 636 | 363 600 |

- Order code for "Sensor version; sensor; insertion tube.", option SB "Bidirectional; stainless steel; stainless steel"
- Order code for "Sensor version; sensor; insertion tube.", option SC "Reverse flow detection; stainless steel; stainless steel"

| DN [in] | Full scale value [lb/h] (Air, 68°F, 14.7 psi a) | | Full scale value [SCFM] (Air, 59°F, 14.7 psi a) | |
|------------|--|-----------|--|---------|
| | Minimum | Maximum | Minimum | Maximum |
| 3 | 29 | 2 981 | 6 | 648 |
| 4 | 52 | 5 257 | 11 | 1 144 |
| 6 | 108 | 10 810 | 23 | 2 354 |
| 8 | 192 | 19 287 | 42 | 4 200 |
| 10 | 301 | 30 155 | 65 | 6 567 |
| 12 | 432 | 43 241 | 94 | 9 417 |
| 16 | 768 | 76 810 | 167 | 16 729 |
| 20 | 1 206 | 120 620 | 262 | 26 272 |
| 24 | 1 735 | 173 533 | 377 | 37 797 |
| 28 | 2 362 | 236 279 | 514 | 51 463 |
| 40 | 4 822 | 482 253 | 1 050 | 105 039 |
| 60 | 10 850 | 1 085 012 | 2 363 | 236 326 |

The flow rates listed are only representative for the calibrated conditions and do not necessarily reflect the measuring capacity of the measuring device under operating conditions and the actual pipe internal diameters present on site. To make sure that the correct device version and sizing is selected to suit the application, contact the sales organization or use the Applicator selection software.

Special applications

High gas flow velocities (>70 m/s)

In the case of high gas flow velocities, it is advisable to read in the process pressure dynamically or to enter the pressure as accurately as possible, as a velocity-dependent correction is performed.

Light gases (hydrogen, helium)

- The reliable measurement of light gases can be difficult due to their very high thermal conductivity. Depending on the application, the flow rates of light gases are often particularly slow and the flow profiles are not sufficiently developed. The flows are frequently in the laminar flow range, while turbulent flow would actually be needed for optimum measurement.
- Despite loss of accuracy and linearity in applications with light gases and low flow rates, the device measures with a good degree of repeatability and is therefore suitable for monitoring flow conditions (e.g. leak detection).
- The recommended inlet runs must be doubled for light gases. →  21

Operable flow range

- 200:1 with factory calibration
- Up to 1000:1 with application-specific adjustment

Input signal

External values

The measuring device provides interfaces which allow values measured externally →  176 to be transmitted to the measuring device:

- Analog inputs 4-20 mA
- Digital inputs

Pressure values can be transmitted as absolute or gauge pressure. For gauge pressure, the atmospheric pressure must be known or specified by the customer.

HART protocol

The measured values are written from the automation system to the measuring device via the HART protocol. The pressure transmitter must support the following protocol-specific functions:

- HART protocol
- Burst mode

Current input

The measured values are written from the automation system to the measuring device via the current input →  176.

Current input 0/4 to 20 mA

| | |
|---------------------------------|--|
| Current input | 0/4 to 20 mA (active/passive) |
| Current span | <ul style="list-style-type: none"> ■ 4 to 20 mA (active) ■ 0/4 to 20 mA (passive) |
| Resolution | 1 µA |
| Voltage drop | Typically: 0.6 to 2 V for 3.6 to 22 mA (passive) |
| Maximum input voltage | ≤ 30 V (passive) |
| Open-circuit voltage | ≤ 28.8 V (active) |
| Possible input variables | <ul style="list-style-type: none"> ■ Pressure ■ Temperature ■ Mol-% (gas analyzer) ■ External reference flow rate (in-situ adjustment) |

Status input

| | |
|-----------------------------|---|
| Maximum input values | <ul style="list-style-type: none"> ■ DC -3 to 30 V ■ If status input is active (ON): R_i >3 kΩ |
| Response time | Configurable: 5 to 200 ms |

| | |
|-----------------------------|--|
| Input signal level | <ul style="list-style-type: none">▪ Low signal: DC -3 to +5 V▪ High signal: DC 12 to 30 V |
| Assignable functions | <ul style="list-style-type: none">▪ Off▪ Reset the individual totalizers separately▪ Reset all totalizers▪ Flow override▪ Second gas group▪ Zero point adjustment |

15.4 Output

Output signal

Current output 4 to 20 mA HART

| | |
|--------------------------------------|---|
| Order code | "Output; input 1" (20): Option BA: current output 4 to 20 mA HART |
| Signal mode | Can be set to: <ul style="list-style-type: none"> ■ Active ■ Passive |
| Current range | Can be set to: <ul style="list-style-type: none"> ■ 4 to 20 mA NAMUR ■ 4 to 20 mA US ■ 4 to 20 mA ■ 0 to 20 mA (only if the signal mode is active) ■ Fixed current |
| Open-circuit voltage | DC 28.8 V (active) |
| Maximum input voltage | DC 30 V (passive) |
| Load | 250 to 700 Ω |
| Resolution | 0.38 μA |
| Damping | Configurable: 0 to 999.9 s |
| Assignable measured variables | <ul style="list-style-type: none"> ■ Mass flow ■ Volume flow ■ Corrected volume flow ■ FAD volume flow ■ Flow velocity ■ Temperature ■ Energy flow ■ Pressure ■ Density ■ Heat flow ■ Electronics temperature ■ 2nd temperature heat difference For SIL (application package), only mass flow |

Current output 4 to 20 mA HART Ex i

| | |
|------------------------------|---|
| Order code | "Output; input 1" (20) choose from: <ul style="list-style-type: none"> ■ Option CA: current output 4 to 20 mA HART Ex i passive ■ Option CC: current output 4 to 20 mA HART Ex i active |
| Signal mode | Depends on the selected order version. |
| Current range | Can be set to: <ul style="list-style-type: none"> ■ 4 to 20 mA NAMUR ■ 4 to 20 mA US ■ 4 to 20 mA ■ 0 to 20 mA (only if the signal mode is active) ■ Fixed current |
| Open-circuit voltage | DC 21.8 V (active) |
| Maximum input voltage | DC 30 V (passive) |
| Load | <ul style="list-style-type: none"> ■ 250 to 400 Ω (active) ■ 250 to 700 Ω (passive) |
| Resolution | 0.38 μA |

| | |
|--------------------------------------|--|
| Damping | Configurable: 0 to 999.9 s |
| Assignable measured variables | <ul style="list-style-type: none"> ▪ Mass flow ▪ Volume flow ▪ Corrected volume flow ▪ FAD volume flow ▪ Flow velocity ▪ Temperature ▪ Energy flow ▪ Pressure ▪ Density ▪ Heat flow ▪ Electronics temperature ▪ 2nd temperature heat difference <p>For SIL (application package), only mass flow</p> |

Current output 4 to 20 mA

| | |
|--------------------------------------|--|
| Order code | "Output; input 2" (21), "Output; input 3" (022): Option B: current output 4 to 20 mA |
| Signal mode | Can be set to: <ul style="list-style-type: none"> ▪ Active ▪ Passive |
| Current span | Can be set to: <ul style="list-style-type: none"> ▪ 4 to 20 mA NAMUR ▪ 4 to 20 mA US ▪ 4 to 20 mA ▪ 0 to 20 mA (only if the signal mode is active) ▪ Fixed current |
| Maximum output values | 22.5 mA |
| Open-circuit voltage | DC 28.8 V (active) |
| Maximum input voltage | DC 30 V (passive) |
| Load | 0 to 700 Ω |
| Resolution | 0.38 μ A |
| Damping | Configurable: 0 to 999.9 s |
| Assignable measured variables | <ul style="list-style-type: none"> ▪ Mass flow ▪ Volume flow ▪ Corrected volume flow ▪ FAD volume flow ▪ Flow velocity ▪ Temperature ▪ Energy flow ▪ Pressure ▪ Density ▪ Heat flow ▪ Electronics temperature ▪ 2nd temperature heat difference <p>For SIL (application package), only mass flow</p> |

Pulse/frequency/switch output

| | |
|-----------------------------|---|
| Function | Can be configured as pulse, frequency or switch output |
| Version | Open collector Can be set to: <ul style="list-style-type: none"> ▪ Active ▪ Passive ▪ Passive NAMUR |
| Maximum input values | DC 30 V, 250 mA (passive) |

| | |
|--------------------------------------|---|
| Open-circuit voltage | DC 28.8 V (active) |
| Voltage drop | For 22.5 mA: ≤ DC 2 V |
| Pulse output | |
| Maximum input values | DC 30 V, 250 mA (passive) |
| Maximum output current | 22.5 mA (active) |
| Open-circuit voltage | DC 28.8 V (active) |
| Pulse width | Configurable: 0.05 to 2 000 ms |
| Maximum pulse rate | 10 000 Impulse/s |
| Pulse value | Configurable |
| Assignable measured variables | <ul style="list-style-type: none"> ▪ Mass flow ▪ Volume flow ▪ Corrected volume flow ▪ FAD volume flow ▪ Energy flow ▪ Heat flow <p>For SIL (application package), only mass flow</p> |
| Frequency output | |
| Maximum input values | DC 30 V, 250 mA (passive) |
| Maximum output current | 22.5 mA (active) |
| Open-circuit voltage | DC 28.8 V (active) |
| Output frequency | Configurable: end value frequency 2 to 10 000 Hz (f _{max} = 12 500 Hz) |
| Damping | Configurable: 0 to 999.9 s |
| Pulse/pause ratio | 1:1 |
| Assignable measured variables | <ul style="list-style-type: none"> ▪ Mass flow ▪ Volume flow ▪ Corrected volume flow ▪ FAD volume flow ▪ Flow velocity ▪ Temperature ▪ Energy flow ▪ Pressure ▪ Density ▪ Heat flow ▪ Electronic temperature ▪ 2nd temperature heat difference <p>For SIL (application package), only mass flow</p> |
| Switch output | |
| Maximum input values | DC 30 V, 250 mA (passive) |
| Open-circuit voltage | DC 28.8 V (active) |
| Switching behavior | Binary, conductive or non-conductive |
| Switching delay | Configurable: 0 to 100 s |

| | |
|-----------------------------------|---|
| Number of switching cycles | Unlimited |
| Assignable functions | <ul style="list-style-type: none"> ■ Off ■ On ■ Diagnostic behavior ■ Limit value <ul style="list-style-type: none"> ■ Off ■ Mass flow ■ Volume flow ■ Corrected volume flow ■ FAD volume flow ■ Heat flow ■ Energy flow ■ Flow velocity ■ Density ■ Calorific value ■ Temperature ■ 2nd temperature heat difference ■ Totalizer 1-3 ■ Electronic temperature ■ Flow direction monitoring ■ Status <ul style="list-style-type: none"> Low flow cut off |

Relay output

| | |
|---|---|
| Function | Switch output |
| Version | Relay output, galvanically isolated |
| Switching behavior | Can be set to: <ul style="list-style-type: none"> ■ NO (normally open), factory setting ■ NC (normally closed) |
| Maximum switching capacity (passive) | <ul style="list-style-type: none"> ■ DC 30 V, 0.1 A ■ AC 30 V, 0.5 A |
| Assignable functions | <ul style="list-style-type: none"> ■ Off ■ On ■ Diagnostic behavior ■ Limit value <ul style="list-style-type: none"> ■ Off ■ Mass flow ■ Volume flow ■ Corrected volume flow ■ FAD volume flow ■ Heat flow ■ Energy flow ■ Flow velocity ■ Density ■ Temperature ■ 2nd temperature heat difference ■ Totalizer 1-3 ■ Electronics temperature ■ Flow direction monitoring ■ Status <ul style="list-style-type: none"> Low flow cut off |

User-configurable input/output

One specific input or output is assigned to a user-configurable input/output (configurable I/O) during device commissioning.

The following inputs and outputs are available for assignment:

- Choice of current output: 4 to 20 mA (active), 0/4 to 20 mA (passive)
- Pulse/frequency/switch output
- Choice of current input: 4 to 20 mA (active), 0/4 to 20 mA (passive)
- Status input

Signal on alarm

Depending on the interface, failure information is displayed as follows:

Current output 0/4 to 20 mA

4 to 20 mA

| | |
|---------------------|---|
| Failure mode | Choose from: <ul style="list-style-type: none"> ▪ 4 to 20 mA in accordance with NAMUR recommendation NE 43 ▪ 4 to 20 mA in accordance with US ▪ Min. value: 3.59 mA ▪ Max. value: 22.5 mA ▪ Definable value between: 3.59 to 22.5 mA ▪ Actual value ▪ Last valid value |
|---------------------|---|

0 to 20 mA

| | |
|---------------------|--|
| Failure mode | Choose from: <ul style="list-style-type: none"> ▪ Maximum alarm: 22 mA ▪ Definable value between: 0 to 20.5 mA |
|---------------------|--|

Pulse/frequency/switch output

| | |
|-------------------------|--|
| Pulse output | |
| Fault mode | Choose from: <ul style="list-style-type: none"> ▪ Actual value ▪ No pulses |
| Frequency output | |
| Fault mode | Choose from: <ul style="list-style-type: none"> ▪ Actual value ▪ 0 Hz ▪ Definable value between: 2 to 12 500 Hz |
| Switch output | |
| Fault mode | Choose from: <ul style="list-style-type: none"> ▪ Current status ▪ Open ▪ Closed |

Relay output

| | |
|---------------------|---|
| Failure mode | Choose from: <ul style="list-style-type: none"> ▪ Current status ▪ Open ▪ Closed |
|---------------------|---|

Local display

| | |
|---------------------------|---|
| Plain text display | With information on cause and remedial measures |
| Backlight | Red lighting indicates a device error. |

 Status signal as per NAMUR recommendation NE 107

Interface/protocol



- Via digital communication:
 - HART protocol
- Via service interface
 - CDI-RJ45 service interface
 - WLAN interface

| | |
|---------------------------|---|
| Plain text display | With information on cause and remedial measures |
|---------------------------|---|

Web browser

| | |
|---------------------------|---|
| Plain text display | With information on cause and remedial measures |
|---------------------------|---|

Light emitting diodes (LED)

| | |
|---------------------------|--|
| Status information | Status indicated by various light emitting diodes The following information is displayed depending on the device version: <ul style="list-style-type: none"> ▪ Supply voltage active ▪ Data transmission active ▪ Device alarm/error has occurred  Diagnostic information via light emitting diodes →  141 |
|---------------------------|--|

Low flow cut off The switch points for low flow cut off are user-selectable.

Galvanic isolation The outputs are galvanically isolated:

- from the power supply
- from one another
- from the potential equalization (PE) terminal

| | | | |
|------------------------|---|--|--|
| Protocol-specific data | Manufacturer ID | 0x11 | |
| | Device type ID | 0x1160 | |
| | HART protocol revision | 7 | |
| | Device description files (DTM, DD) | Information and files under: www.endress.com | |
| | HART load | Min. 250 Ω | |
| | System integration | Information on system integration →  73. <ul style="list-style-type: none"> ▪ Measured variables via HART protocol ▪ Burst Mode functionality | |

15.5 Power supply

Terminal assignment →  36

| | | | | |
|----------------|----------------------------------|-------------------------|------------|------------------------|
| Supply voltage | Order code "Power supply" | Terminal voltage | | Frequency range |
| | Option D | DC 24 V | ±20% | – |
| | Option E | AC 100 to 240 V | –15...+10% | 50/60 Hz, ±4 Hz |

| Order code "Power supply" | Terminal voltage | | Frequency range |
|------------------------------|------------------|------------|-----------------|
| Option I | DC 24 V | ±20% | – |
| | AC 100 to 240 V | –15...+10% | 50/60 Hz, ±4 Hz |

Power consumption

Transmitter

Max. 10 W (active power)

| | |
|--------------------------|---|
| switch-on current | Max. 36 A (<5 ms) as per NAMUR Recommendation NE 21 |
|--------------------------|---|

Current consumption

Transmitter

- Max. 400 mA (24 V)
- Max. 200 mA (110 V, 50/60 Hz; 230 V, 50/60 Hz)

Power supply failure

- Totalizers stop at the last value measured.
- Depending on the device version, the configuration is retained in the device memory or in the pluggable data memory (HistoROM DAT).
- Error messages (incl. total operated hours) are stored.

Overcurrent protection element

The device must be operated with a dedicated circuit breaker, as it does not have an ON/OFF switch of its own.

- The circuit breaker must be easy to reach and labeled accordingly.
- Permitted nominal current of the circuit breaker: 2 A up to maximum 10 A.

Electrical connection

→  36

Potential equalization

→  39

Terminals

Spring-loaded terminals: Suitable for strands and strands with ferrules.
Conductor cross-section 0.2 to 2.5 mm² (24 to 12 AWG).

Cable entries

- Cable gland: M20 × 1.5 with cable Ø 6 to 12 mm (0.24 to 0.47 in)
- Thread for cable entry:
 - NPT ½"
 - G ½"
 - M20

Cable specification

→  33



Overvoltage protection

| | |
|--|---|
| Mains voltage fluctuations | →  183 |
| Overvoltage category | Overvoltage category II |
| Short-term, temporary overvoltage | Up to 1200 V between cable and ground, for max. 5 s |
| Long-term, temporary overvoltage | Up to 500 V between cable and ground |

15.6 Performance characteristics

Reference operating conditions

- Error limits based on ISO 11631
- Dry air with +20 to +30 °C (+68 to +86 °F) at 0.8 to 1.5 bar (12 to 22 psi)
- Specifications as per calibration protocol
- Accuracy based on accredited calibration rigs that are traced to ISO 17025.

 To obtain measured errors, use the *Applicator* sizing tool →  171

Maximum measured error

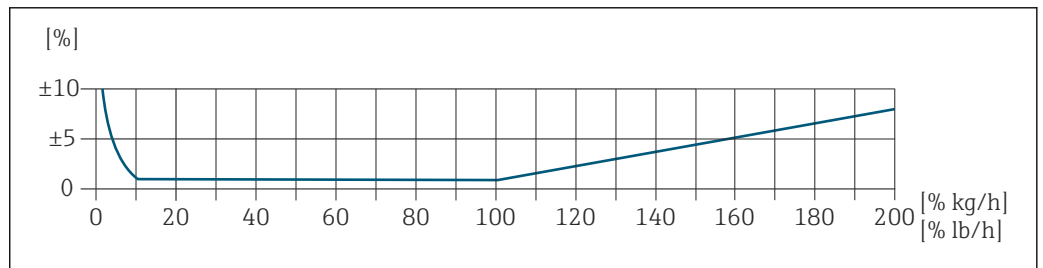

A0042739

Calibrated measuring range



The measuring accuracy is specified in relation to the mass flow and divided into two ranges:

- ±1.0 % of the current measured value for 100% to 10% of the calibrated measuring range (under reference operating conditions)
- ±0.10 % of the calibrated full scale value for 10% to 1% of the calibrated measuring range (under reference operating conditions)

The measuring device is calibrated and adjusted on an accredited and traceable calibration rig and its accuracy is certified in a calibration report ¹⁾ (5 control points).

Order code for "Calibration flow":

- Option G "Factory calibration": calibration report (5 control points)
- Option K "Traceable ISO/IEC17025": Swiss Calibration Services (SCS) calibration report (5 control points) which confirms traceability to the national calibration standard

 For information on calibrated measuring ranges and maximum full scale values →  173

Extended measuring range

The device has an extended measuring range that goes beyond the maximum calibrated value (100%). Here, the last measured values in the calibrated range are taken and then extrapolated. The end of the extrapolated range is only reached once the productive energy of the sensor is exceeded and/or the Mach number is greater than listed below.

| Mach number | Order code |
|-------------|---|
| 0.2 | <ul style="list-style-type: none"> ▪ Order code for "Sensor version; sensor; insertion tube:", option SB "Bidirectional; stainless steel; stainless steel" ▪ Order code for "Sensor version; sensor; insertion tube:", option SC "Reverse flow detection; stainless steel; stainless steel" |
| 0.4 | <ul style="list-style-type: none"> ▪ Order code for "Sensor version; sensor; insertion tube:", option SA "Unidirectional; stainless steel; stainless steel" ▪ Order code for "Sensor version; sensor; insertion tube:", option HA "Unidirectional; Alloy; stainless steel" |

1) Two calibration reports for the order code for "Sensor version; sensor; insertion tube:", option SB "Bidirectional; stainless steel; stainless steel"

The accuracy is specified in relation to the mass flow.
 $\pm 1.0\% \pm (\text{current measured value in } \% - 100\%) \times 0.07$ for 100% to 200% of the calibrated measuring range (under reference operating conditions)

Accuracy of outputs

The outputs have the following base accuracy specifications.

Current output

| | |
|-----------------|---------------------|
| Accuracy | $\pm 5 \mu\text{A}$ |
|-----------------|---------------------|

Pulse/frequency output

o.r. = of reading

| | |
|-----------------|--|
| Accuracy | Max. ± 50 ppm o.r. (over the entire ambient temperature range) |
|-----------------|--|

Repeatability $\pm 0.25\%$ of the display value for velocities above 1.0 m/s (3.3 ft/s)

Response time Typically < 3 s for 63 % of a step change (in both directions)

Influence of ambient temperature

Current output

| | |
|--------------------------------|-------------------------------------|
| Temperature coefficient | Max. $1 \mu\text{A}/^\circ\text{C}$ |
|--------------------------------|-------------------------------------|

Pulse/frequency output

| | |
|--------------------------------|---|
| Temperature coefficient | No additional effect. Included in accuracy. |
|--------------------------------|---|

Influence of medium temperature Air: 0.02 % per $^\circ\text{C}$ (0.036 % per $^\circ\text{F}$) of the process temperature change in relation to the reference temperature

Influence of medium pressure Air: 0.3 % per bar (0.02 % per psi) of the process pressure change (from the set process pressure)

15.7 Mounting

Mounting requirements →  19

15.8 Environment

| | | |
|---------------------------|---|---|
| Ambient temperature range | Measuring device | <ul style="list-style-type: none"> ■ -40 to +60 °C (-40 to +140 °F) ■ Order code for "Test, certificate", option JP: -50 to +60 °C (-58 to +140 °F) |
| | Readability of the local display | -20 to +60 °C (-4 to +140 °F) The readability of the display may be impaired at temperatures outside the temperature range. |

NOTICE

Danger of overheating

- ▶ Ensure that the temperature at the lower end of the transmitter housing does not exceed 80 °C (176 °F).
- ▶ Ensure that sufficient convection takes place at the transmitter neck.
- ▶ When using in potentially explosive atmospheres, observe the information in the device-specific Ex documentation. For detailed information on the temperature tables, see the separate document entitled "Safety Instructions" (XA) for the device.
- ▶ Ensure that a sufficiently large area of the transmitter neck remains exposed. The uncovered part serves as a radiator and protects the electronics from overheating and excessive cooling.
- ▶ If operating outdoors:
Avoid direct sunlight, particularly in warm climatic regions.

 You can order a weather protection cover from Endress+Hauser →  168.

| | |
|---------------------|---|
| Storage temperature | -50 to +80 °C (-58 to +176 °F), preferably at +20 °C (+68 °F) |
|---------------------|---|

| | |
|------------|---|
| Atmosphere | If a plastic transmitter housing is permanently exposed to certain steam and air mixtures, this can damage the housing. |
|------------|---|

 In cases of doubt, please contact the Sales Center.

| | |
|----------------------|---|
| Degree of protection | Transmitter |
| | <ul style="list-style-type: none"> ■ IP66/67, Type 4X enclosure, suitable for pollution degree 4 ■ When the housing is open: IP20, Type 1 enclosure, suitable for pollution degree 2 ■ Display module: IP20, Type 1 enclosure, suitable for pollution degree 2 |

Optional

Order code for "Sensor options", option CC "IP68, Type 6P, Cust-potted"

External WLAN antenna

IP67

| | |
|---------------------------------|---|
| Vibration- and shock-resistance | Vibration sinusoidal, in accordance with IEC 60068-2-6 |
| | <ul style="list-style-type: none"> ■ 2 to 8.4 Hz, 3.5 mm peak ■ 8.4 to 2 000 Hz, 1 g peak |

Vibration broad-band random, according to IEC 60068-2-64

- 10 to 200 Hz, 0.003 g²/Hz
- 200 to 2 000 Hz, 0.001 g²/Hz
- Total: 1.54 g rms

Shock half-sine, according to IEC 60068-2-27

6 ms 30 g

Rough handling shocks according to IEC 60068-2-31

Interior cleaning

Suitable for cleaning-in-place (CIP) and sterilization-in-place (SIP).

Manufacturer options for delivery of parts

- Oil- and grease-free wetted parts, no declaration. Order code for "Service", option HA.
- Oil- and grease-free wetted parts as per IEC/TR 60877-2.0 and BOC 50000810-4, with declaration. Order code for "Service", option HB. The plant operator must ensure that the measuring device meets the requirements of the operator's oxygen application.

Electromagnetic compatibility (EMC)

As per IEC/EN 61326 and NAMUR Recommendation 21 (NE 21)



Details are provided in the Declaration of Conformity.



This unit is not intended for use in residential environments and cannot guarantee adequate protection of the radio reception in such environments.

15.9 Process

Medium temperature range Sensor
 -40 to +180 °C (-40 to +356 °F)

Seals

- Sealing rings:
 - EPDM -40 to +140 °C (-40 to +284 °F)
 - FKM -40 to +180 °C (-40 to +356 °F)
- Ferrule:
 - PEEK -40 to +140 °C (-40 to +284 °F)
 - PVDF -20 to +110 °C (-4 to +230 °F)
 - 1.4404 -40 to +180 °C (-40 to +356 °F)

i Ferrule in 1.4404: ferrule has a fixed position on the shaft. Restriction for repeat calibrations (observe minimum insertion depth → [20](#))

Medium pressure range Minimum 0.5 bar absolute. Maximum permitted medium pressure → [189](#)

Pressure/temperature ratings The following pressure/temperature diagrams apply to all pressure-bearing parts of the device and not just the process connection. The diagrams show the maximum permissible medium pressure depending on the specific medium temperature.

Ferrule

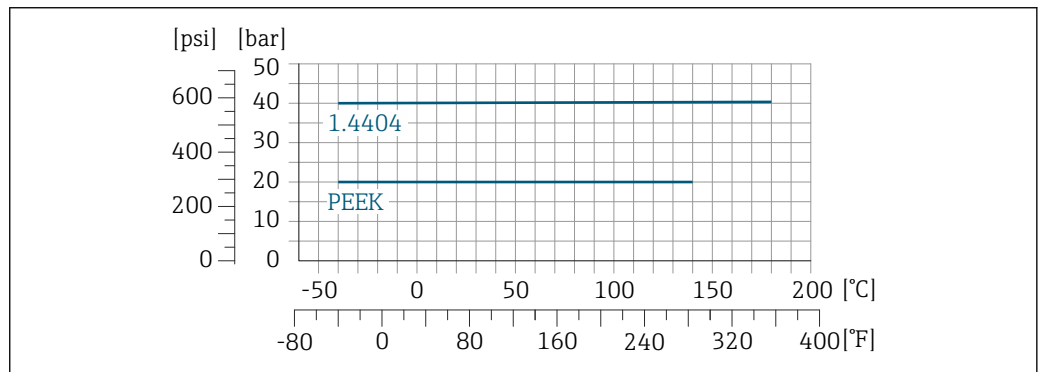

44 With compression fitting material 1.4404/F316L/F316

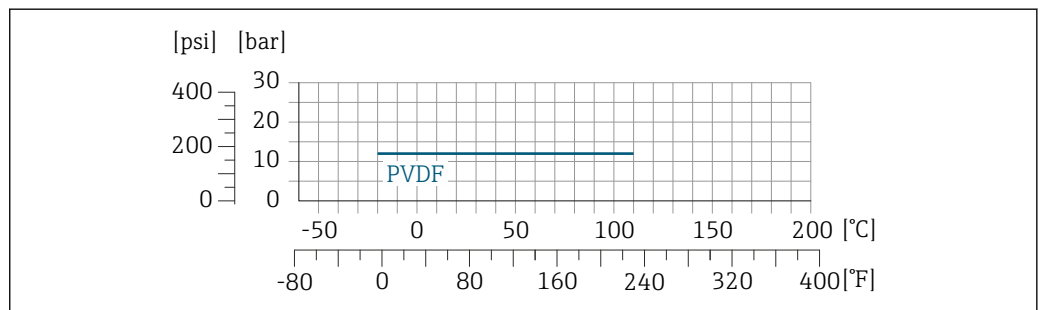

45 With compression fitting material 1.4404/F316L/F316

Flow limit **i** Measuring range → [173](#)

The maximum flow depends on the gas type and the pipe nominal diameter used. The end of the measuring range is reached when the Mach number listed below is reached.

| Mach number | Order code |
|-------------|---|
| 0.2 | <ul style="list-style-type: none"> ■ Order code for "Sensor version; sensor; insertion tube.", option SB "Bidirectional; stainless steel; stainless steel" ■ Order code for "Sensor version; sensor; insertion tube.", option SC "Reverse flow detection; stainless steel; stainless steel" |
| 0.4 | <ul style="list-style-type: none"> ■ Order code for "Sensor version; sensor; insertion tube.", option SA "Unidirectional; stainless steel; stainless steel" ■ Order code for "Sensor version; sensor; insertion tube.", option HA "Unidirectional; Alloy; stainless steel" |

 Use the Applicator to size the device.

Pressure loss

 Use the Applicator for precise calculations.

System pressure

→  26

Hot tap, process pressure

Only use the hot tap for mounting and removal at process pressure for non-toxic, innocuous gases.

Medium pressure version

- Max. process pressure: 20 bar (290 psi)
- Max. extraction pressure: 16 bar (230 psi)
- Max. extraction temperature: +50 °C (+122 °F)
- Min. insertion sensor length: 435mm (17")

Low pressure version

- Max. process pressure: 20 bar (290 psi)
- Max. extraction pressure: 4.5 bar (65 psi)
- Max. extraction temperature: +50 °C (+122 °F)
- Min. insertion sensor length: 335mm (13")

Cold tap, ambient pressure

Cold tap for mounting and removal at ambient pressure.

- Max. process pressure: 20 bar (290 psi)
- Max. extraction pressure: 1 bar (14.5 psi)
- Max. extraction temperature: +50 °C (+122 °F)
- Min. insertion sensor length: 335mm (13")

Mounting boss

To mount the device directly on the process pipe.

Max. process pressure: 40 bar (580 psi)

15.10 Mechanical construction

Design, dimensions



For the dimensions and installation lengths of the device, see the "Technical Information" document, "Mechanical construction" section .

Weight

All values (weight exclusive of packaging material) refer to devices with EN/DIN PN 40 flanges. Weight specifications including transmitter as per order code for "Housing", option A "Aluminum, coated".

Different values due to different transmitter versions:

Transmitter version for the hazardous area

(Order code for "Housing", option A "Aluminum, coated"; Ex d): +2 kg (+4.4 lbs)

Weight in SI units

| Installed length [mm] | Weight [kg] |
|-----------------------|-------------|
| 235 | 4.8 |
| 335 | 4.9 |
| 435 | 5 |
| 608 | 5.1 |

Weight in US units

| Installed length [in] | Weight [lbs] |
|-----------------------|--------------|
| 9 | 10.6 |
| 13 | 10.8 |
| 17 | 11 |
| 24 | 11.2 |

Materials

Transmitter housing

Order code for "Housing":

Option **A** "Aluminum, coated": aluminum, AlSi10Mg, coated

Window material

Order code for "Housing":

Option **A** "Aluminum, coated": glass

Cable entries/cable glands

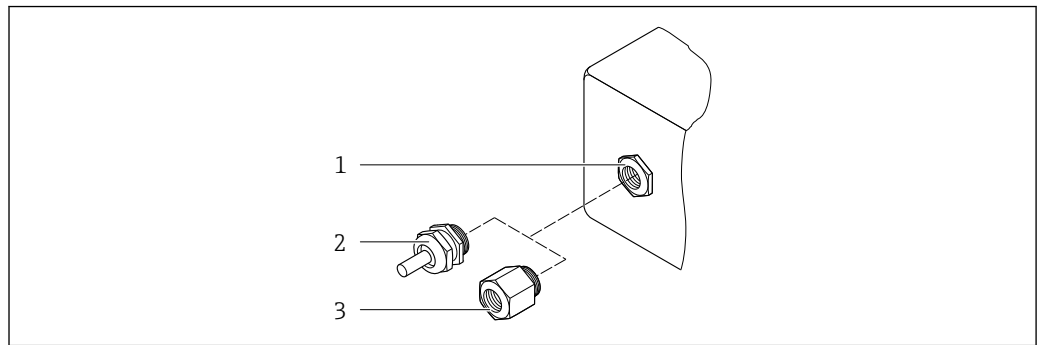

A0020640

46 Possible cable entries/cable glands

- 1 Female thread M20 × 1.5
- 2 Cable gland M20 × 1.5
- 3 Adapter for cable entry with female thread G ½" or NPT ½"

Order code for "Housing", option A "Aluminum, coated"

The various cable entries are suitable for hazardous and non-hazardous areas.

| Cable entry/cable gland | Material |
|---|-------------------------------------|
| Compression fitting M20 × 1.5 | Non-Ex: plastic |
| | Z2, D2, Ex d/de: brass with plastic |
| Adapter for cable entry with female thread G ½" | Nickel-plated brass |
| Adapter for cable entry with female thread NPT ½" | |

Materials for insertion tube

Stainless steel, 1.4404 (316/316L)

Process connections, process coupling

Stainless steel, 1.4404 (316/316L)

Sensing element

Unidirectional

- Stainless steel, 1.4404 (316/316L)
- Alloy C22, 2.4602 (UNS N06022);

Bidirectional

Stainless steel, 1.4404 (316/316L)

Reverse flow detection

Stainless steel, 1.4404 (316/316L)

Ferrules

- PEEK
- PVDF
- 1.4404 (316/316L)

Flat ring seal

- EPDM
- FKM

 For aggressive media (e.g. chlorine or ozone), we recommend special materials (Alloy for sensing element, PVDF or 1.4404 for ferrules and FKM for flat seal). For any requests, please contact the Endress+Hauser sales organization responsible for your area.

Sensor guard

Stainless steel, 1.4404 (316/316L)

Accessories*Protective cover*

Stainless steel, 1.4404 (316L)

External WLAN antenna

- Antenna: ASA plastic (acrylonitrile styrene acrylate) and nickel-plated brass
- Adapter: Stainless steel and nickel-plated brass
- Cable: Polyethylene
- Plug: Nickel-plated brass
- Angle bracket: Stainless steel

Mounting boss (DK6MB)

Stainless steel, 1.4404 (316/316L)

*Cold/hot tap, low pressure and medium pressure**Welding socket*

Stainless steel 1.4404 (316L)

Ball valve

- Stainless cast steel CF3M or CF8M
- Seal: PTFE

Sensor connection



Stainless steel, 1.4404 (316/316L)

Cold tap, atmospheric pressure

- Stainless steel, 1.4404 (316/316L)
- Stainless cast steel CF3M or CF8M
- Seal: PTFE

Process connections

- G $\frac{3}{4}$ ", ISO 228/1 compression fitting
- G1", ISO 228/1, compression fitting
- $\frac{3}{4}$ " NPT, compression fitting
- 1" NPT, compression fitting

 For information on the different materials used in the process connections →  192

15.11 Display and user interface

Languages

Can be operated in the following languages:



- Via local operation
English, German, French, Spanish, Italian, Dutch, Portuguese, Polish, Russian, Turkish, Chinese, Japanese, Korean, Vietnamese, Czech, Swedish
- Via Web browser
English, German, French, Spanish, Italian, Dutch, Portuguese, Polish, Russian, Turkish, Chinese, Japanese, Vietnamese, Czech, Swedish
- Via "FieldCare", "DeviceCare" operating tool: English, German, French, Spanish, Italian, Chinese, Japanese

Local operation

Via display module

Equipment:

- Order code for "Display; operation", option F "4-line, illuminated, graphic display; touch control"
- Order code for "Display; operation", option G "4-line, illuminated, graphic display; touch control + WLAN"

 Information about WLAN interface →  68

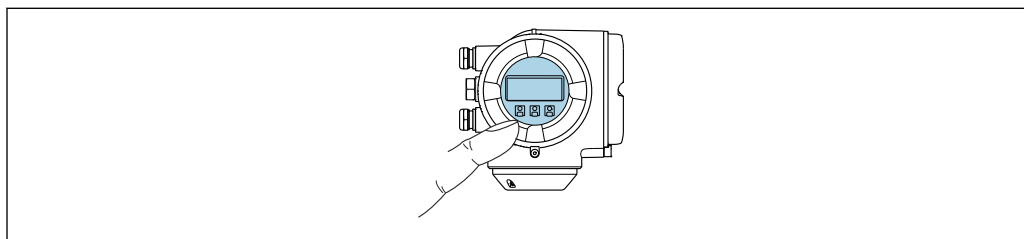



A0026785

 47 Operation with touch control



Display elements

- 4-line, illuminated, graphic display
- White background lighting; switches to red in event of device errors
- Format for displaying measured variables and status variables can be individually configured

Operating elements

- External operation via touch control (3 optical keys) without opening the housing: , , 
- Operating elements also accessible in the various zones of the hazardous area

Via remote display and operating module DKX001

 The remote display and operating module DKX001 is available as an optional extra →  168.

- The measuring device is always supplied with a dummy cover when the remote display and operating module DKX001 is ordered directly with the measuring device. Display or operation at the transmitter is not possible in this case.
- If ordered subsequently, the remote display and operating module DKX001 may not be connected at the same time as the existing measuring device display module. Only one display or operation unit may be connected to the transmitter at any one time.

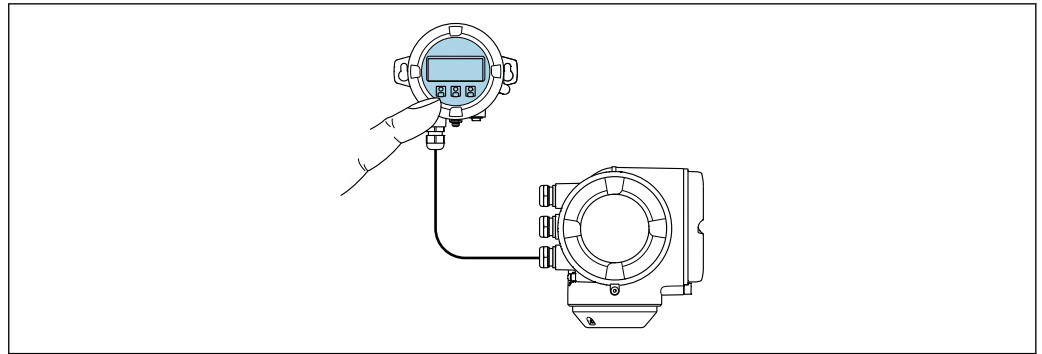

A0026786

48 Operation via remote display and operating module DKX001

Display and operating elements

The display and operating elements correspond to those of the display module → 194.

Housing material

| Transmitter housing | | Remote display and operating module |
|-----------------------------|------------------|-------------------------------------|
| Order code for "Housing" | Material | Material |
| Option A "Aluminum, coated" | AlSi10Mg, coated | AlSi10Mg, coated |

Cable entry

Corresponds to the choice of transmitter housing, order code for "Electrical connection".

Connecting cable

→ 34

Dimensions



Information about dimensions:



"Mechanical construction" section of the "Technical Information" document.

Remote operation → 66

Service interface → 67

Supported operating tools Different operating tools can be used for local or remote access to the measuring device. Depending on the operating tool used, access is possible with different operating units and via a variety of interfaces.

| Supported operating tools | Operating unit | Interface | Additional information |
|---------------------------|--|---|----------------------------------|
| Web browser | Notebook, PC or tablet with web browser | <ul style="list-style-type: none"> ▪ CDI-RJ45 service interface ▪ WLAN interface | Special Documentation for device |
| DeviceCare SFE100 | Notebook, PC or tablet with Microsoft Windows system | <ul style="list-style-type: none"> ▪ CDI-RJ45 service interface ▪ WLAN interface ▪ Fieldbus protocol | → 171 |

| Supported operating tools | Operating unit | Interface | Additional information |
|---------------------------|--|---|--|
| FieldCare SFE500 | Notebook, PC or tablet with Microsoft Windows system | <ul style="list-style-type: none"> ▪ CDI-RJ45 service interface ▪ WLAN interface ▪ Fieldbus protocol | →  171 |
| Field Xpert | SMT70/77/50 | <ul style="list-style-type: none"> ▪ All Fieldbus protocols ▪ WLAN interface ▪ Bluetooth ▪ CDI-RJ45 service interface | Operating Instructions BA01202S Device description files: Use update function of handheld terminal |
| SmartBlue app | Smart phone or tablet with iOS or Android | WLAN | →  171 |

 Other operating tools based on FDT technology with a device driver such as DTM/iDTM or DD/EDD can be used for device operation. These operating tools are available from the individual manufacturers. Integration into the following operating tools, among others, is supported:

- FactoryTalk AssetCentre (FTAC) from Rockwell Automation → www.rockwellautomation.com
- Process Device Manager (PDM) from Siemens → www.siemens.com
- Asset Management Solutions (AMS) from Emerson → www.emersonprocess.com
- FieldCommunicator 375/475 from Emerson → www.emersonprocess.com
- Field Device Manager (FDM) from Honeywell → www.process.honeywell.com
- FieldMate from Yokogawa → www.yokogawa.com
- PACTWare → www.pactware.com

The related device description files are available: www.endress.com → Download Area



Web server

With the integrated web server, the device can be operated and configured via a web browser service interface (CDI-RJ45) or WLAN interface. The structure of the operating menu is the same as for the local display. In addition to the measured values, status information on the device is displayed and can be used to monitor device health. Furthermore the device data can be managed and the network parameters can be configured.

A device that has a WLAN interface (can be ordered as an option) is required for the WLAN connection: order code for "Display; operation", option G "4-line, illuminated; touch control + WLAN". The device acts as an Access Point and enables communication by computer or a mobile handheld terminal.

Supported functions

Data exchange between the operating unit (such as a notebook, for example,) and measuring device:

- Upload the configuration from the measuring device (XML format, configuration backup)
- Save the configuration to the measuring device (XML format, restore configuration)
- Export event list (.csv file)
- Export parameter settings (.csv file or PDF file, document the measuring point configuration)
- Export the Heartbeat verification log (PDF file, only available with the **Heartbeat Verification** →  202 application package)
- Flash firmware version for device firmware upgrade, for example
- Download driver for system integration
- Visualize up to 1000 saved measured values (only available with the **Extended HistoROM** application package →  202)

 Special Documentation for web server

HistoROM data management The measuring device features HistoROM data management. HistoROM data management comprises both the storage and import/export of key device and process data, making operation and servicing far more reliable, secure and efficient.

 When the device is delivered, the factory settings of the configuration data are stored as a backup in the device memory. This memory can be overwritten with an updated data record, for example after commissioning.

Additional information on the data storage concept

There are different types of data storage units in which device data are stored and used by the device:

| | HistoROM backup | T-DAT | S-DAT |
|-------------------------|--|--|---|
| Available data | <ul style="list-style-type: none"> ▪ Event logbook, e.g. diagnostic events ▪ Parameter data record backup ▪ Device firmware package | <ul style="list-style-type: none"> ▪ Measured value logging ("Extended HistoROM" order option) ▪ Current parameter data record (used by firmware at run time) ▪ Indicator (minimum/maximum values) ▪ Totalizer value | <ul style="list-style-type: none"> ▪ Sensor data: e.g. nominal diameter ▪ Serial number ▪ Calibration data ▪ Device configuration (e.g. SW options, fixed I/O or multi I/O) |
| Storage location | Fixed on the user interface PC board in the connection compartment | Can be plugged into the user interface PC board in the connection compartment | In the sensor plug in the transmitter neck part |

Data backup

Automatic

- The most important device data (sensor and transmitter) are automatically saved in the DAT modules
- If the transmitter or measuring device is replaced: once the T-DAT containing the previous device data has been exchanged, the new measuring device is ready for operation again immediately without any errors
- If exchanging the electronics module (e.g. I/O electronics module): Once the electronics module has been replaced, the software of the module is compared against the current device firmware. The module software is upgraded or downgraded where necessary. The electronics module is available for use immediately afterwards and no compatibility problems occur.

Manual

Additional parameter data record (complete parameter settings) in the integrated device memory HistoROM backup for:

- Data backup function
Backup and subsequent restoration of a device configuration in the device memory HistoROM backup
- Data comparison function
Comparison of the current device configuration with the device configuration saved in the device memory HistoROM backup

Data transmission

Manual

Transfer of a device configuration to another device using the export function of the specific operating tool, e.g. with FieldCare, DeviceCare or Web server: to duplicate the configuration or to store in an archive (e.g. for backup purposes)

Event list**Automatic**

- Chronological display of up to 20 event messages in the events list
- If the **Extended HistoROM** application package (order option) is enabled: up to 100 event messages are displayed in the events list along with a time stamp, plain text description and remedial measures
- The events list can be exported and displayed via a variety of interfaces and operating tools e.g. DeviceCare, FieldCare or Web server

Data logging**Manual**

If the **Extended HistoROM** application package (order option) is enabled:

- Recording of 1 to 4 channels of up to 1 000 measured values (up to 250 measured values per channel)
- User configurable recording interval
- Export the measured value log via a variety of interfaces and operating tools e.g. FieldCare, DeviceCare or web server

15.12 Certificates and approvals

Current certificates and approvals for the product are available at www.endress.com on the relevant product page:

1. Select the product using the filters and search field.
2. Open the product page.
3. Select **Downloads**.

| | |
|--------------|--|
| CE mark | <p>The device meets the legal requirements of the applicable EU Directives. These are listed in the corresponding EU Declaration of Conformity along with the standards applied.</p> <p>Endress+Hauser confirms successful testing of the device by affixing to it the CE mark.</p> |
| UKCA marking | <p>The device meets the legal requirements of the applicable UK regulations (Statutory Instruments). These are listed in the UKCA Declaration of Conformity along with the designated standards. By selecting the order option for UKCA marking, Endress+Hauser confirms a successful evaluation and testing of the device by affixing the UKCA mark.</p> <p>Contact address Endress+Hauser UK: Endress+Hauser Ltd. Floats Road Manchester M23 9NF United Kingdom www.uk.endress.com</p> |
| RCM marking | <p>The measuring system meets the EMC requirements of the "Australian Communications and Media Authority (ACMA)".</p> |
| Ex approval | <p>The measuring device is certified for use in hazardous areas and the relevant safety instructions are provided in the separate "Safety Instructions" (XA) document. Reference is made to this document on the nameplate.</p> <p>Devices with the order code for "Approval", option BB or BD have equipment protection level (EPL) Ga/Gb (Zone 0 in the measuring tube).</p> <p> The separate Ex documentation (XA) containing all the relevant explosion protection data is available from your Endress+Hauser sales center.</p> |

ATEX, IECEx

Currently, the following versions for use in hazardous areas are available:

Ex db eb

| Category | Type of protection |
|----------|-------------------------------|
| II1/2G | Ex db eb ia IIC T4...T1 Ga/Gb |
| II2G | Ex db eb ia IIC T4...T1 Gb |

Ex db

| Category | Type of protection |
|----------|----------------------------|
| II1/2G | Ex db ia IIC T4...T1 Ga/Gb |
| II2G | Ex db ia IIC T4...T1 Gb |

Ex ec

| Category | Type of protection |
|----------|----------------------|
| IIG | Ex ec IIC T4...T1 Gc |

Ex tb

| Category | Type of protection |
|----------|----------------------|
| II2D | Ex tb IIIC T** °C Db |

cCSA_{US}

Currently, the following versions for use in hazardous areas are available:

XP (Ex d)

Class I, II, III Division 1 Groups A-G

NI (Ex ec)

Class I Division 2 Groups A - D

Ex de

- Class I, Zone 1 AEx/ Ex de ia IIC T4...T1 Ga/Gb
- Class I, Zone 1 AEx/ Ex de ia IIC T4...T1 Gb

Ex db

- Class I, Zone 1 AEx/ Ex db ia IIC T4...T1 Ga/Gb
- Class I, Zone 1 AEx/ Ex db ia IIC T4...T1 Gb

Ex ec

Class I, Zone 2 AEx/ Ex ec IIC T4...T1 Gc

Ex tb



Zone 21 AEx/ Ex tb IIIC T** °C Db

Functional safety

The measuring device can be used for flow monitoring systems (min., max., range) up to SIL 2 (single-channel architecture; order code for "Additional approval", option LA) and SIL 3 (multi-channel architecture with homogeneous redundancy) and is independently evaluated and certified in accordance with IEC 61508.

The following types of monitoring in safety equipment are possible:

Mass flow

 Functional safety manual with information and restrictions for the SIL device
→  203

HART certification



HART interface

The measuring device is certified and registered by the FieldComm Group. The measuring system meets all the requirements of the following specifications:

- Certified according to HART 7
- The device can also be operated with certified devices of other manufacturers (interoperability)

Radio approval

The measuring device has radio approval.



 For detailed information on the radio approval, see the Special Documentation
→  203

| | |
|---|--|
| Additional certification | <p>CRN approval</p> <p>Some device versions have CRN approval. A CRN-approved process connection with a CSA approval must be ordered for a CRN-approved device.</p> |
| External standards and guidelines | <ul style="list-style-type: none"> ■ EN 60529 Degrees of protection provided by enclosure (IP code) ■ EN 61010-1 Safety requirements for electrical equipment for measurement, control and laboratory use - general requirements ■ IEC/EN 61326-2-3 Emission in accordance with Class A requirements. Electromagnetic compatibility (EMC requirements). ■ NAMUR NE 21 Electromagnetic compatibility (EMC) of industrial process and laboratory control equipment ■ NAMUR NE 32 Data retention in the event of a power failure in field and control instruments with microprocessors ■ NAMUR NE 43 Standardization of the signal level for the breakdown information of digital transmitters with analog output signal. ■ NAMUR NE 53 Software of field devices and signal-processing devices with digital electronics ■ NAMUR NE 105 Specifications for integrating fieldbus devices in engineering tools for field devices ■ NAMUR NE 107 Self-monitoring and diagnosis of field devices ■ NAMUR NE 131 Requirements for field devices for standard applications ■ ETSI EN 300 328 Guidelines for 2.4 GHz radio components. ■ EN 301489 Electromagnetic compatibility and radio spectrum matters (ERM). |
| Classification of process sealing between electrical systems and (flammable or combustible) process fluids in accordance with ANSI/ISA 12.27.01 | <p>Endress+Hauser devices are designed in accordance with ANSI/ISA 12.27.01, allowing the user to waive the use and save the cost of installing external secondary process seals in the conduit as required by the process sealing sections of ANSI/NFPA 70 (NEC) and CSA 22.1 (CEC). These devices comply with the North American installation practice and provide a very safe and cost-saving installation for pressurized applications with hazardous fluids. Further information can be found in the control drawings of the relevant devices.</p> |

15.13 Application packages

Many different application packages are available to enhance the functionality of the device. Such packages might be needed to address safety aspects or specific application requirements.

The application packages can be ordered with the device or subsequently from Endress+Hauser. Detailed information on the order code in question is available from your local Endress+Hauser sales center or on the product page of the Endress+Hauser website: www.endress.com.

 Detailed information on the application packages:
Special Documentation →  203

Diagnostic functionality

Order code for "Application package", option EA "Extended HistoROM"

Comprises extended functions concerning the event log and the activation of the measured value memory.

Event log:

Memory volume is extended from 20 message entries (standard version) to up to 100 entries.

Data logging (line recorder):

- Memory capacity for up to 1000 measured values is activated.
- 250 measured values can be output via each of the 4 memory channels. The recording interval can be defined and configured by the user.
- Measured value logs can be accessed via the local display or operating tool e.g. FieldCare, DeviceCare or Web server.

 For detailed information, see the Operating Instructions for the device.

Heartbeat Technology

Order code for "Application package", option EB "Heartbeat Verification + Monitoring"

Heartbeat Verification

Meets the requirement for traceable verification to DIN ISO 9001:2008 Chapter 7.6 a) "Control of monitoring and measuring equipment".

- Functional testing in the installed state without interrupting the process.
- Traceable verification results on request, including a report.
- Simple testing process via local operation or other operating interfaces.
- Clear measuring point assessment (pass/fail) with high test coverage within the framework of manufacturer specifications.
- Extension of calibration intervals according to operator's risk assessment.

Heartbeat Monitoring

Continuously supplies data, which are characteristic of the measuring principle, to an external condition monitoring system for the purpose of preventive maintenance or process analysis. These data enable the operator to:



- Draw conclusions - using these data and other information - about the impact on the measuring performance over time.
- Schedule servicing in time.
- Monitor the process or product quality , e.g. process stability.

 Special Documentation SD02712D

Second gas group

| Package | Description |
|------------------|---|
| Second gas group | This application package enables the configuration of two different standard gases/gas mixtures in the device and allows the user to switch from one gas group to another using the status input or (if available) via bus communication. |

15.14 Accessories

 Overview of accessories available for order →  168

15.15 Documentation

 For an overview of the scope of the associated Technical Documentation, refer to the following:

- *Device Viewer* (www.endress.com/deviceviewer): Enter the serial number from the nameplate
- *Endress+Hauser Operations app*: Enter serial number from nameplate or scan matrix code on nameplate.

Standard documentation **Brief Operating Instructions**

Brief Operating Instructions for the sensor

| Measuring device | Documentation code |
|------------------|--------------------|
| Proline t-mass I | KA01443D |

Brief Operating Instructions for transmitter

| Measuring device | Documentation code |
|------------------|--------------------|
| Proline 300 | KA01444D |

Technical Information

| Measuring device | Documentation code |
|------------------|--------------------|
| t-mass I 300 | TI01501D |

Description of Device Parameters

| Measuring device | Documentation code |
|------------------|--------------------|
| t-mass 300 | GP01143D |

Supplementary device-
dependent documentation

Safety instructions

Safety instructions for electrical equipment for hazardous areas.

| Contents | Documentation code |
|-----------------------|--------------------|
| ATEX/IECEX Ex d/Ex de | XA01965D |
| ATEX/IECEX Ex ec | XA01966D |
| cCSAus XP | XA01969D |
| cCSAus Ex d/ Ex de | XA01967D |
| cCSAus Ex nA | XA01968D |

Remote display and operating module DKX001

| Contents | Documentation code |
|------------------|--------------------|
| ATEX/IECEX Ex i | XA01494D |
| ATEX/IECEX Ex ec | XA01498D |
| cCSAus IS | XA01499D |
| cCSAus Ex nA | XA01513D |
| INMETRO Ex i | XA01500D |
| INMETRO Ex ec | XA01501D |
| NEPSI Ex i | XA01502D |
| NEPSI Ex nA | XA01503D |

Functional safety manual

| Contents | Documentation code |
|--------------------|--------------------|
| Proline t-mass 300 | SD02483D |

Special documentation

| Contents | Documentation code |
|---|--------------------|
| Information on the Pressure Equipment Directive | SD01614D |
| Remote display and operating module DKX001 | SD01763D |
| Radio approvals for WLAN interface for A309/A310 display module | SD01793D |
| Web server | SD02485D |
| Heartbeat Technology | SD02477D |

Installation Instructions

| Contents | Comment |
|---|---|
| Installation instructions for spare part sets and accessories | <ul style="list-style-type: none"> ▪ Access the overview of all the available spare part sets via <i>Device Viewer</i> →  166 ▪ Accessories available for order with Installation Instructions |

Index

A

- Access authorization to parameters
 - Read access 58
 - Write access 58
- Access code 58
 - Incorrect input 58
- Adapting the diagnostic behavior 149
- Adapting the status signal 149
- Additional certification 201
- Ambient temperature
 - Influence 186
- AMS Device Manager 71
 - Function 71
- Application 172
- Approvals 199

B

- Burst mode 75

C

- Cable entries
 - Technical data 184
- Cable entry
 - Degree of protection 43
- CE mark 10, 199
- Certificates 199
- Check
 - Connection 44
- Checklist
 - Post-connection check 44
 - Post-installation check 32
- Cleaning
 - Cleaning the sensing element 164
 - Exterior cleaning 164
 - Sensing element 164
- Cold tap, ambient pressure 190
- Commissioning 78
 - Advanced settings 105
 - Configuring the measuring device 79
- Communication-specific data 73
- Connecting cable 33, 34
- Connecting the measuring device 36
- Connecting the signal cables 36
- Connecting the supply voltage cables 36
- Connection
 - see Electrical connection
- Connection preparations 36
- Connection tools 33
- Context menu
 - Calling up 54
 - Closing 54
 - Explanation 54
- Current consumption 184

D

- Date of manufacture 16, 17

- Declaration of Conformity 10
- Defining the access code 124, 125
- Degree of protection 43, 187
- Device components 14
- Device description files 73
- Device locking, status 128
- Device name
 - Sensor 17
 - Transmitter 16
- Device repair 166
- Device revision 73
- Device type ID 73
- Device Viewer 166
- DeviceCare 71
 - Device description file 73
- Diagnosis
 - Symbols 142
- Diagnostic behavior
 - Explanation 143
 - Symbols 143
- Diagnostic information
 - Design, description 143, 147
 - DeviceCare 147
 - FieldCare 147
 - Light emitting diodes 141
 - Local display 142
 - Overview 151
 - Remedial measures 151
 - Web browser 145
- Diagnostic list 155
- Diagnostic message 142
- DIP switch
 - see Write protection switch
- Direct access 56
- Direct access code 50
- Disabling write protection 124
- Display
 - see Local display
- Display and operating module DKX001 194
- Display area
 - For operational display 48
 - In the navigation view 50
- Display values
 - For locking status 128
- Displaying data logging 135
- Disposal 167
- Document
 - Function 6
 - Symbols 6
- Document function 6

E

- Editing view 52
 - Input screen 53
 - Using operating elements 52, 53

- Electrical connection
 - Commubox FXA195 (USB) 66
 - Computer with web browser (e.g. Microsoft Edge) 66
 - Degree of protection 43
 - Field Communicator 475 66
 - Field Xpert SFX350/SFX370 66
 - Field Xpert SMT70 66
 - Measuring device 33
 - Operating tool (e.g. FieldCare, AMS Device Manager, SIMATIC PDM) 66
 - Operating tools
 - Via HART protocol 66
 - Via service interface (CDI-RJ45) 67
 - Via WLAN interface 68
 - VIATOR Bluetooth modem 66
 - Web server 67
 - WLAN interface 68
- Electromagnetic compatibility 188
- Electronics module 14
- Enabling write protection 124
- Enabling/disabling the keypad lock 59
- Endress+Hauser services
 - Maintenance 165
 - Repair 166
- Environment
 - Storage temperature 187
 - Vibration- and shock-resistance 187
- Error messages
 - see Diagnostic messages
- Event list 157
- Event logbook 157
- Ex approval 199
- Extended order code
 - Sensor 17
 - Transmitter 16
- Exterior cleaning 164
- F**
- Field Communicator
 - Function 72
- Field Communicator 475 72
- Field of application
 - Residual risks 10
- Field Xpert
 - Function 69
- Field Xpert SFX350 69
- FieldCare 69
 - Device description file 73
 - Establishing a connection 70
 - Function 69
 - User interface 71
- Filtering the event logbook 157
- Firmware
 - Release date 73
 - Version 73
- Firmware history 163
- Flow conditioner 22
- Flow limit 189
- Function range
 - AMS Device Manager 71
 - SIMATIC PDM 72
- Function scope
 - Field Communicator 72
 - Field Communicator 475 72
 - Field Xpert 69
- Functional Safety (SIL) 200
- Functions
 - see Parameters
- G**
- Galvanic isolation 183
- H**
- Hardware write protection 126
- HART certification 200
- HART protocol
 - Device variables 73
 - Measured variables 73
 - Revision 73
- Help text
 - Calling up 57
 - Closing 57
 - Explanation 57
- HistoROM 112, 121
- Hot tap, process pressure 190
- I**
- Identifying the measuring device 15
- Incoming acceptance 15
- Influence
 - Ambient temperature 186
 - Medium pressure 186
- Information about this document 6
- Input 173
- Inspection
 - Installation 32
 - Received goods 15
- Installation conditions
 - Sensor heating 26
 - System pressure 26
- Intended use 9
- L**
- Languages, operation options 194
- Line recorder 135
- Local display 194
 - Navigation view 50
 - see Diagnostic message
 - see In alarm condition
 - see Operational display
 - Text editor 52
- Low flow cut off 183
- M**
- Main electronics module 14
- Maintenance 164
- Maintenance tasks 164
 - Recalibration 165

- Managing the device configuration 112, 121
 - Manufacturer ID 73
 - Materials 191
 - Measured variables
 - see Process variables
 - Measuring and test equipment 165
 - Measuring device
 - Configuring 79
 - Conversion 166
 - Disposal 167
 - Integrating via HART protocol 73
 - Preparing for electrical connection 36
 - Preparing for mounting 28
 - Removing 167
 - Repairs 166
 - Structure 14
 - Switching on 78
 - Measuring principle 172
 - Measuring system 172
 - Medium pressure
 - Influence 186
 - Menu
 - Diagnostics 155
 - Setup 80
 - Menus
 - For measuring device configuration 79
 - For specific settings 105
 - Mounting 19
 - Mounting preparations 28
 - Mounting tool 28
- N**
- Nameplate
 - Sensor 17
 - Transmitter 16
 - Navigation path (navigation view) 50
 - Navigation view
 - In the submenu 50
 - In the wizard 50
 - Numeric editor 52
- O**
- Onsite display
 - Numeric editor 52
 - Operable flow range 176
 - Operating elements 54, 143
 - Operating keys
 - see Operating elements
 - Operating menu
 - Menus, submenus 46
 - Structure 46
 - Submenus and user roles 47
 - Operating philosophy 47
 - Operation 128
 - Operation options 45
 - Operational display 48
 - Operational safety 10
 - Order code 16, 17
 - Output signal 178
 - Output variables 178
- P**
- Packaging disposal 18
 - Parameter
 - Changing 57
 - Entering values or text 57
 - Parameter settings
 - Adjustment values in use (Submenu) 119
 - Administration (Submenu) 114
 - Advanced setup (Submenu) 105
 - Burst configuration 1 to n (Submenu) 75
 - Configuration backup (Submenu) 112, 121
 - Current input 89
 - Current input (Wizard) 89
 - Current input 1 to n (Submenu) 131
 - Current output 91
 - Current output (Wizard) 91
 - Data logging (Submenu) 135
 - Define access code (Wizard) 114
 - Device information (Submenu) 161
 - Diagnostics (Menu) 155
 - Display (Submenu) 107
 - Display (Wizard) 101
 - I/O configuration 88
 - I/O configuration (Submenu) 88
 - In-situ adjustment (Submenu) 117
 - Low flow cut off (Wizard) 104
 - Measurement mode (Wizard) 80
 - Process variables (Submenu) 129
 - Pulse/frequency/switch output 94
 - Pulse/frequency/switch output (Wizard) 94, 95, 98
 - Pulse/frequency/switch output 1 to n (Submenu) 133
 - Reference conditions (Submenu) 84
 - Relay output 100
 - Relay output 1 to n (Submenu) 133
 - Relay output 1 to n (Wizard) 100
 - Reset access code (Submenu) 114
 - Setup (Menu) 80
 - Simulation (Submenu) 122
 - Status input 90
 - Status input 1 to n (Submenu) 90, 131
 - System units (Submenu) 86
 - System values (Submenu) 130
 - Totalizer (Submenu) 130
 - Totalizer 1 to n (Submenu) 105
 - Totalizer handling (Submenu) 134
 - Value current output 1 to n (Submenu) 132
 - Web server (Submenu) 65
 - WLAN settings (Wizard) 110
 - Post-connection check 78
 - Post-connection check (checklist) 44
 - Post-installation check (checklist) 32
 - Post-mounting check 78
 - Potential equalization 39
 - Power consumption 184
 - Power supply failure 184
 - Process
 - Cold tap, ambient pressure 190

- Hot tap, process pressure 190
- Process connections 193
- Product safety 10
- Protecting parameter settings 124
- R**
- Radio approval 200
- RCM marking 199
- Read access 58
- Reading off measured values 128
- Recalibration 165
- Registered trademarks 8
- Remedial measures
 - Calling up 144
 - Closing 144
- Remote operation 195
- Repair 166
 - Notes 166
- Repair of a device 166
- Replacement
 - Device components 166
- Requirements for personnel 9
- Response time 186
- Return 166
- S**
- Safety 9
- Sensor adjustment 85
- Sensor heating 26
- Serial number 16, 17
- Setting the operating language 78
- Settings
 - Adapting the measuring device to the process conditions 134
 - Administration 113
 - Advanced display configurations 107
 - Current input 89
 - Current output 91
 - I/O configuration 88
 - In-situ adjustment 115
 - Local display 101
 - Low flow cut off 104
 - Managing the device configuration 112, 121
 - Measurement mode 80
 - Operating language 78
 - Pulse output 94
 - Pulse/frequency/switch output 94, 95
 - Reference conditions 84
 - Relay output 100
 - Resetting the device 160
 - Resetting the totalizer 134
 - Simulation 122
 - Status input 90
 - Switch output 98
 - System units 86
 - Tag name 80
 - Totalizer 105
 - Totalizer reset 134
 - WLAN 110
- Signal on alarm 182
- SIL (functional safety) 200
- SIMATIC PDM 72
 - Function 72
- Software release 73
- Spare part 166
- Spare parts 166
- Special
 - Installation instructions 27
 - Special connection instructions 40
- Standards and guidelines 201
- Status area
 - For operational display 48
 - In the navigation view 50
- Status signals 142, 145
- Storage concept 197
- Storage conditions 18
- Storage temperature 18
- Storage temperature range 187
- Structure
 - Measuring device 14
 - Operating menu 46
- Submenu
 - Adjustment values in use 119
 - Administration 113, 114
 - Advanced setup 105
 - Burst configuration 1 to n 75
 - Configuration backup 112, 121
 - Current input 1 to n 131
 - Data logging 135
 - Device information 161
 - Display 107
 - Event list 157
 - I/O configuration 88
 - In-situ adjustment 117
 - Input values 131
 - Measured values 128
 - Output values 132
 - Overview 47
 - Process variables 129
 - Pulse/frequency/switch output 1 to n 133
 - Reference conditions 84
 - Relay output 1 to n 133
 - Reset access code 114
 - Simulation 122
 - Status input 1 to n 90, 131
 - System units 86
 - System values 130
 - Totalizer 130
 - Totalizer 1 to n 105
 - Totalizer handling 134
 - Value current output 1 to n 132
 - Web server 65
- Supply voltage 183
- Switch output 181
- Symbols
 - Controlling data entries 53
 - For communication 48
 - For diagnostic behavior 48

| | |
|---|-----|
| For locking | 48 |
| For measured variable | 48 |
| For measurement channel number | 48 |
| For menus | 50 |
| For parameters | 50 |
| For status signal | 48 |
| For submenu | 50 |
| For wizard | 50 |
| In the status area of the local display | 48 |
| Input screen | 53 |
| Operating elements | 52 |
| System design | |
| Measuring system | 172 |
| see Measuring device design | |
| System integration | 73 |
| System pressure | 26 |
| T | |
| Technical data, overview | 172 |
| Temperature range | |
| Ambient temperature range for display | 194 |
| Storage temperature | 18 |
| Terminal assignment | 36 |
| Terminals | 184 |
| Text editor | 52 |
| Tool | |
| For mounting | 28 |
| Transport | 18 |
| Tool tip | |
| see Help text | |
| Tools | |
| Electrical connection | 33 |
| Totalizer | |
| Configuring | 105 |
| Transmitter | |
| Turning the display module | 31 |
| Turning the housing | 30 |
| Transporting the measuring device | 18 |
| Troubleshooting | |
| General | 138 |
| Turning the display module | 31 |
| Turning the electronics housing | |
| see Turning the transmitter housing | |
| Turning the transmitter housing | 30 |
| U | |
| UKCA marking | 199 |
| Use of measuring device | |
| Borderline cases | 9 |
| Incorrect use | 9 |
| see Intended use | |
| User interface | |
| Current diagnostic event | 155 |
| Previous diagnostic event | 155 |
| User roles | 47 |
| V | |
| Version data for the device | 73 |
| Vibration- and shock-resistance | 187 |

| | |
|---|------------|
| W | |
| W@M | 165, 166 |
| W@M Device Viewer | 15 |
| Weight | |
| SI units | 191 |
| Transport (notes) | 18 |
| US units | 191 |
| Wizard | |
| Current input | 89 |
| Current output | 91 |
| Define access code | 114 |
| Display | 101 |
| Low flow cut off | 104 |
| Measurement mode | 80 |
| Pulse/frequency/switch output | 94, 95, 98 |
| Relay output 1 to n | 100 |
| WLAN settings | 110 |
| WLAN settings | 110 |
| Workplace safety | 10 |
| Write access | 58 |
| Write protection | |
| Via access code | 124 |
| Via write protection switch | 126 |
| Write protection switch | 126 |



www.addresses.endress.com
