



User Manual

Gasurveyor 700

IR gas detector with Natural Gas discrimination





WARNING: ALL INDIVIDUALS WHO, HAVE OR WILL HAVE, RESPONSIBILITY FOR USING, MAINTAINING, OR SERVICING THIS PRODUCT, MUST READ THIS ENTIRE MANUAL CAREFULLY. FAILURE TO USE THIS EQUIPMENT PROPERLY COULD RESULT IN SERIOUS INJURY OR DEATH.

LEGAL STATEMENT

Teledyne, the Teledyne Logo, Gas Measurement Instruments, GMI, and Gasurveyor 700 are registered and/or unregistered marks of Teledyne Gas Measurement Instruments Ltd, also referred to as "the Company."

All rights reserved. No part of this documentation may be reproduced in any form or by any means or used to make any derivative work (such as translation, transformation, or adaptation) without written permission from the Company.

Microsoft, Windows, Windows 2000, Windows Me, Windows XP, Windows NT, Windows Vista, Windows 7, Windows 10, Internet Explorer and MS-DOS are either trademarks or registered trademarks of Microsoft Corporation in the United States and other countries. Solaris and JAVA are either trademarks or registered trademarks of Sun Microsystems, Inc. All other products or service names are the property of their respective owners.

DESCRIPTION

This User Manual provides information for use only with the Gasurveyor 700 Portable Gas Monitor (or "the monitor").

LIABILITY

Every care has been taken in the preparation of this user guide, but the Company does not accept any responsibility for errors or omissions and their consequences. Information in this user guide is subject to change without notice. This user manual does not constitute a specification or basis for a contract.

Piped natural gas has a range of compositions, and in some cases may be chemically similar to non-piped gases present in the atmosphere. Therefore any Teledyne GMI products which include a Pipeline Gas Test function is for indication and advisory purposes only and should not be relied upon as the sole indicator for confirming the type of gas present in the environment. Teledyne GMI shall not therefore be held liable for any direct costs or consequential costs, losses or expenses incurred by the user whilst solely relying on a Pipeline Gas Test function in order to determine the presence of piped natural gas.

MODIFICATION NOTICES

The Company aims to notify customers of relevant changes in the product operation and maintain this user guide up to date. Due to continuous product improvement, there may be operational differences between the latest product and this user guide.

This user guide is an important part of the monitor, and it should be referred to for the life of the product.

SOFTWARE

Any software supplied must only be used in this product and may not be copied without the written permission of the Company. Reproduction or disassembly of such embodied programs or algorithms is prohibited. Ownership of such software is not transferable, and the Company does not warrant that the operation of the software will be error free or that the software will meet the customer's requirements.

DISPOSAL ADVICE

Dispose of the monitor carefully and with respect for the environment. If returned, the Company will dispose of the monitor without charge.

AREAS OF USE

Exposure to certain chemicals can result in a loss of sensor sensitivity. Where such environments are known or suspected it is recommended that more frequent response checks are carried out. Chemical compounds that can cause loss of sensitivity includes Silicones, Lead, Halogens and Sulphur.

Environmental factors may affect sensor readings. This includes changes in pressure, humidity and temperature. Note that both pressure and humidity changes can also affect the amount of oxygen present in the atmosphere.

Do not use the monitor in a potentially hazardous atmospheres containing greater than 21% oxygen.



WARNING: ANY RAPID UPSCALE READING, FOLLOWED BY A DECLINING OR ERRATIC READING, MAY INDICATE A GAS CONCENTRATION BEYOND THE UPPER SCALE LIMIT, WHICH MAY BE HAZARDOUS.

SPECIAL CONDITIONS OF USE

The monitor is designed for use in harsh environments. The monitor is sealed to IP55 and, if not subjected to misuse or malicious damage, will provide many years of reliable service.

The monitor may contain electrochemical sensors. Under conditions of prolonged storage, these sensors should be removed. These sensors contain potentially corrosive liquid and care should be taken when handling or disposing, particularly when a leak is suspected.

Only use permitted external probes specified in the product certification.
The equipment must not be subject to prolonged exposure to light when not in use.

ELECTROMAGNETIC COMPATIBILITY (EMC) DIRECTIVE

As stated on the EU Declaration of Conformity accompanying the product, the GS700 series has been tested and conforms to standard EN50270: Electromagnetic compatibility - Electrical apparatus for the detection and measurement of combustible gases, toxic gases and oxygen.



CAUTION: Exposure to radio frequency energy outside this standard may cause erroneous operation.



Table of Contents

1.	About This Guide	8
1.1.	Guide Conventions	8
1.2.	Safety	8
1.2.1.	Additional Safety Requirement - CSA Only.....	9
1.2.2.	Certifications And Approvals	10
1.2.3.	Batteries	10
1.2.4.	Equipment Parameters	11
2.	Introduction	12
2.1.	Monitor Overview	12
2.2.	Key Features.....	12
2.3.	Monitor Ranges	12
2.4.	Modes of Operation	13
2.5.	Monitor Construction	13
2.6.	Display	14
2.6.1.	Soft Keys	14
2.6.2.	Status Bar.....	15
3.	Operation.....	16
3.1.	Operating Procedure	16
3.2.	Quick Configuration Display.....	16
3.3.	Switching the Monitor ON / Warm-up Sequence	16
3.3.1.	Monitor Identification	17
3.3.2.	Date & Time	17
3.3.3.	Bump Due Date	17
3.3.4.	Calibration and Service Due Dates.....	18
3.3.5.	Soundness Test	19
3.3.6.	Alarm Levels	20
3.3.7.	Sensors Zero Check.....	21
3.4.	Switching the Monitor OFF.....	21
4.	Modes of Operation	22
4.1.	Gas Leak Outdoors / Indoors	23
4.1.1.	Available Ranges	23
4.1.2.	Features.....	23
4.1.3.	Display	23
4.1.4.	Soft-keys Functions.....	24
4.1.5.	Logging	24
4.1.5.	Barhole Testing	25

4.2.	Confined Space Monitor (CSM)	27
4.2.1.	Available Ranges	28
4.2.2.	Features	28
4.2.3.	Display	28
4.2.4.	Soft-keys Functions	28
4.2.5.	Logging	28
4.2.6.	Gas Readings & Alarm Set-points Viewer	29
4.3.	Purge	29
4.3.1.	Available Ranges	29
4.3.2.	Features	30
4.3.3.	Display	30
4.3.4.	Soft-keys Functions	30
4.3.5.	Logging	31
4.4.	Search	31
4.4.1.	Available Ranges	31
4.4.2.	Features	31
4.4.3.	Display	32
4.4.4.	Soft-keys Functions	32
4.4.5.	Logging	33
4.5.	Pipeline Gas Test (PGT)	33
5.	Alarms	35
5.1.	Instantaneous Gas Alarms	35
5.2.	Time-averaged Toxic Gas Alarms	36
5.3.	Ticker (Geiger) Gas Alarm	36
5.4.	Available Gas Alarms	36
5.5.	Gas Alarms Examples	36
5.6.	Gas Alarm Options	37
5.6.1.	Alarm Intensity	37
5.6.2.	Latching / Non Latching	38
5.6.3.	Muting	38
5.7.	Warnings & Fault Alarms	38
5.7.1.	Confidence Signal	38
5.7.2.	Battery Warning	38
5.7.3.	Over-range Alarm	39
5.7.4.	Zero Fault	39
5.7.5.	Sample Fault	40
6.	Operator Maintenance	41
6.1.	Replacing Alkaline Batteries	41

6.2.	Recharging the Battery Pack.....	42
6.2.1.	Charging the Monitor.....	43
6.2.2.	Replacing / Charging the Battery Pack.....	44
6.3.	Cleaning.....	45
6.4.	Replacing the Filters.....	45
6.4.1.	Probe Handle Filter Replacement.....	46
6.4.2.	Inlet Nozzle Filter Replacement.....	46
6.5.	Screen Contrast Adjustment.....	47
7.	Bump Test.....	48
7.1.	Manual Bump Test (LEL only).....	48
7.2.	Manual Bump Test (all ranges).....	50
7.3.	Automatic Bump Test.....	51
8.	Calibration.....	52
8.1.	Calibration Validity.....	52
8.2.	Field Calibration.....	52
8.3.	Manual Calibration.....	55
8.3.	Automatic Calibration.....	55
9.	Accessories.....	56
9.1.	Consumables.....	56
9.2.	Accessories.....	56
9.3.	Software.....	56
10.	Monitor Specifications.....	57
11.	Technical Support.....	59
Appendix A:	Pipeline Gas Test (pre firmware v1.30).....	60

Page intentionally left blank.

1. About This Guide

This guide instructs gas detection personnel on the features and usage of the Gasurveyor 700 (or “the monitor”). It also provides information on configuration, operation, maintenance, specifications and trouble shooting. This user guide assumes the reader has a basic knowledge of gas detection procedures.

1.1. Guide Conventions

The following visual elements are used throughout this guide:



WARNING: THIS ICON AND TEXT INDICATE A POTENTIALLY HAZARDOUS SITUATION, WHICH, IF NOT AVOIDED, COULD RESULT IN DEATH OR INJURY.



Caution: This icon and text indicate an action or situation, which, if not avoided, could result in damage to the equipment.



Note: This icon and text designates information of special note to the operator.

1.2. Safety

- Read and understand this guide before operating the monitor.
- The monitor must be regularly serviced and calibrated by fully trained personnel in a safe area.
- Only Teledyne GMI replacement parts should be used. Substitution of components may impair intrinsic safety.
- If the monitor detects gas, follow your own organization’s procedures and operational guidelines.
- Any right of claim relating to product liability or consequential damage to any third party against Teledyne GMI is removed if warnings are not observed.
- This equipment is designed and manufactured to protect against other hazards as defined in paragraph 1.2.7 of Annex II of the ATEX Directive 2014/34/EU.
- Batteries: Alkaline or Rechargeable batteries must be exchanged in a safe area and fitted correctly before use. Never use damaged batteries or expose to extreme heat. [See Section 6: Operator Maintenance](#) for more details.



WARNING: TO PREVENT IGNITION OF FLAMMABLE OR COMBUSTIBLE ATMOSPHERES, REMOVE BATTERIES BEFORE SERVICING.



WARNING: TO PREVENT IGNITION OF FLAMMABLE OR COMBUSTIBLE ATMOSPHERES, READ, UNDERSTAND AND ADHERE TO THE MANUFACTURER’S MAINTENANCE PROCEDURES.



WARNING: TO REDUCE THE RISK OF IGNITION OF A FLAMMABLE OR EXPLOSIVE ATMOSPHERE, BATTERIES MUST BE CHANGED ONLY IN A LOCATION KNOWN TO BE NON-HAZARDOUS.



WARNING: TO REDUCE RISK OF EXPLOSION, DO NOT MIX OLD BATTERIES WITH USED BATTERIES OR MIX BATTERIES FROM DIFFERENT MANUFACTURERS.



WARNING: NEVER ATTEMPT TO RECHARGE NON-RECHARGEABLE CELLS.



Caution: Not for use in oxygen enriched atmospheres.

1.2.1 Additional Safety Requirements - CSA Only



CAUTION: Before each days usage, test on a known concentration of methane, equivalent to 25 - 50% of full scale concentration. Accuracy must be within 0 to +20% of actual. Accuracy may be corrected by calibration. (Refer to Chapter: 'CALIBRATION').

ATTENTION: Avant chaque utilisation journalière, testez la réaction de l'appareil en utilisant une concentration connue en méthane, correspondant à 25-50% de la lecture à fond d'échelle. La précision doit se situer entre 0 et +20% de la valeur réelle. La précision peut se corriger en étalonnant l'appareil (voir Chapitre: CALIBRATION).



CAUTION: Any rapid up-scale readings followed by a declining or erratic reading may indicate a gas concentration beyond the upper scale limit, which may be hazardous.

ATTENTION: Toute lecture dépassant rapidement le maximum de l'échelle et suivie par une diminution ou une lecture erronée, indique une concentration de gaz supérieure à la valeur maximale de cette échelle. Cette lecture n'est pas significative.



CAUTION: Substitution of components may impair intrinsic safety.

ATTENTION: le remplacement d'un composant peut porter atteinte à la sécurité intrinsèque du produit.



CAUTION: Do not charge in a hazardous area. Um = 6.78V.

ATTENTION: Ne pas charger en zone dangereuse. Um = 6.78V.



Note: CSA have only assessed the LEL combustible gas detection portion of this monitor for performance.

Note: CSA a seulement évalué la partie LIE pour la mesure des performances en détection de gaz inflammables.



Note: The monitor performs internal checking of sensor sensitivity, which during calibration will prevent the sensor being calibrated if it has been contaminated or reached its end of life.

1.2.2 Certification and Approvals

The monitor has the following approvals:

		Mark
ATEX		II 2 G Ex db ia IIC T4 Gb $-20^{\circ}\text{C} \leq T_a \leq 50^{\circ}\text{C}$
		* II 2 G Ex db ia IIB T3 Gb $-20^{\circ}\text{C} \leq T_a \leq 50^{\circ}\text{C}$ SIRA 15 ATEX2299X
IECEX		Ex db ia IIC T4 Gb $-20^{\circ}\text{C} \leq T_a \leq 50^{\circ}\text{C}$
		* Ex db ia IIB T3 Gb $-20^{\circ}\text{C} \leq T_a \leq 50^{\circ}\text{C}$ IECEX SIR 15.0105X
CSA		Class I, Div.1 Groups A, B, C and D T4
		Class I, Zone 1 AEx db ia IIC T4 Gb Ex db ia IIC T4 Gb
		* Class I, Div.1 Groups C and D T3 * Class I, Zone 1 AEx db ia IIB T3 Gb Ex db ia IIB T3 Gb
China		Ex d ia IIC T4 Gb
		Ex d ia IIB T3 Gb (when fitted with semiconductor PPM sensor).
		GB 3836.1-2010
		GB 3836.2-2010
		GB 3836.4-2010

* The GS7xx series is certified for use with for Gas Group IIC, Temperature Classification T4 except when the Semiconductor gas sensor is fitted. With a semiconductor sensor fitted either internally or externally the GS7xx is certified for Gas Group IIB and Temperature Classification T3.

1.2.3 Batteries

The GS700 has 2 battery options:

- Alkaline.
- Lithium-Ion rechargeable pack



Note: [See Section 6: Operator Maintenance](#) for more details.



Caution: Only use the following approved size 'D' (LR20) alkaline batteries:

- ANSMANN: Industrial or X-Power
- DURACELL: Industrial or Procell
- PANASONIC: Evolta or Pro Power
- ENERGIZER: Industrial
- AMAZON: Basics
- RAYOVAC: Fusion (*only T3 rated monitors*)



CAUTION: Remove batteries if the monitor will be stored for longer than 3 months.

1.2.4 Equipment Parameters

GS700 Instrument:

U_m : 6.78V (Rechargeable Battery, part number - 49221)

Temperature Range: $-20^{\circ}\text{C} \leq T_a \leq 50^{\circ}\text{C}$

GS700 Charger:

U_m : 250V

U_o : 6.78V

Temperature Range: $-20^{\circ}\text{C} \leq T_a \leq 44^{\circ}\text{C}$

2. Introduction

2.1. Monitor Overview

The Gasurveyor 700 (GS700) is the first choice for all gas utility applications. Reliable measurements are performed using innovative infrared sensing technology including instantaneous confirmation that the gas sample is natural gas.

This lightweight, rugged instrument is easy to use thanks to an intuitive menu layout on a large display.

2.2. Key Features

- Infrared Technology
- Natural gas discrimination
- GPS (optional)
- Bluetooth and IrDA communication
- Leak detection from PPM to Volume gas
- Flexible configuration (gas ranges & modes of operation)
- Compatible with the GDUnet – Teledyne GMI Auto Calibration System

2.3. Monitor Ranges

The following ranges are available in the GS700:

- 0-10,000 ppm Flammable
- 0-100% LEL Flammable
- 0-100% VOL Flammable
- 0-25% Oxygen (O₂)
- 0-1000 ppm Carbon Monoxide (CO)
- 0-100 ppm Hydrogen Sulphide (H₂S)



Note: See [Section 10: Monitor Specifications](#) for more details.



Note: Your GS700 may not have all ranges fitted.

2.4. Modes of Operation

Gas Leak Outdoors (GLO)	Used by technicians to investigate outdoor odour or leak complaints and to pinpoint leaks. This mode supports the optional Barhole feature.
Gas Leak Indoors (GLI)	Similar to the GLO mode, but without Barhole testing.
Confined Space Monitor (CSM)	Used for confined space pre-entry testing and for personal monitoring in potentially hazardous areas.
Purge	Used in gas and air purging applications.
Search	Used to quickly find small leaks using a semiconductor sensor and fast pump.



Note: Pipeline Gas Test is an optional feature. When configured, it can be active in ALL modes of operation, except for CSM.

2.5. Monitor Construction

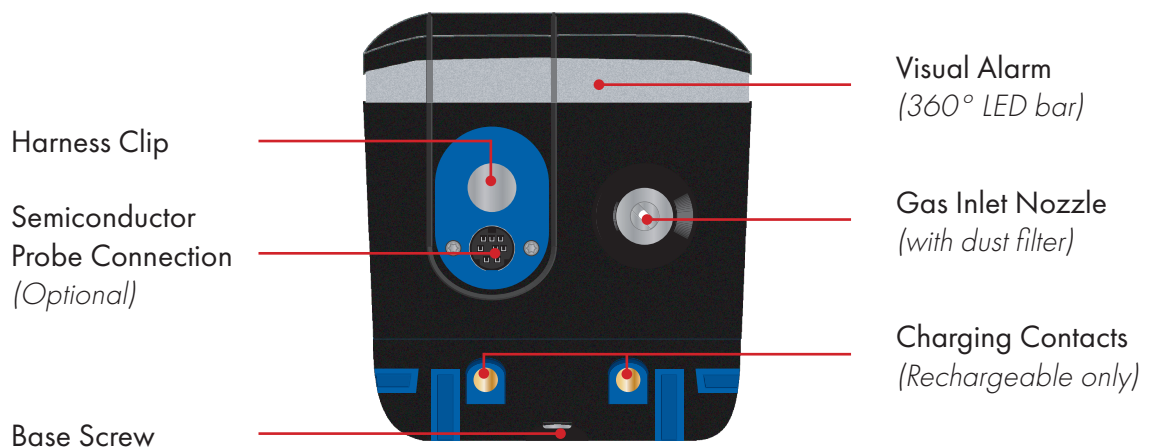

Figure 1: GS700 - Right View

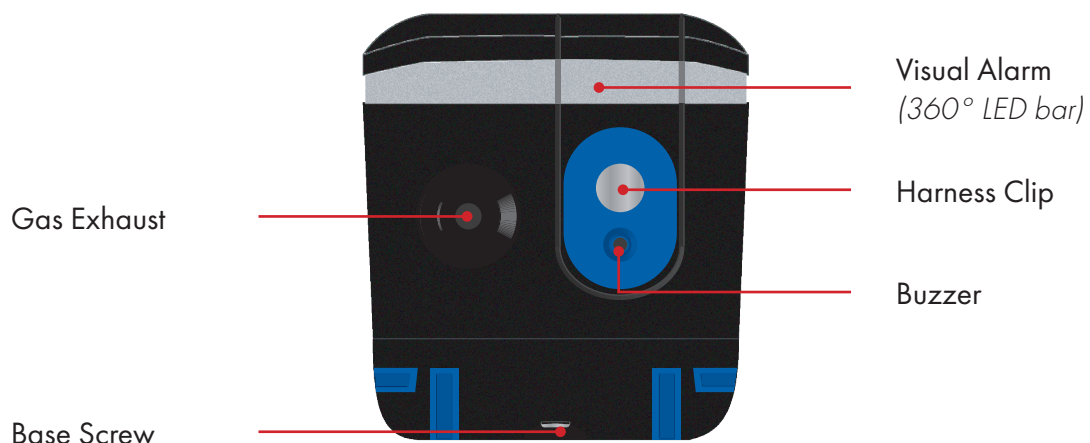

Figure 2: GS700 - Left View

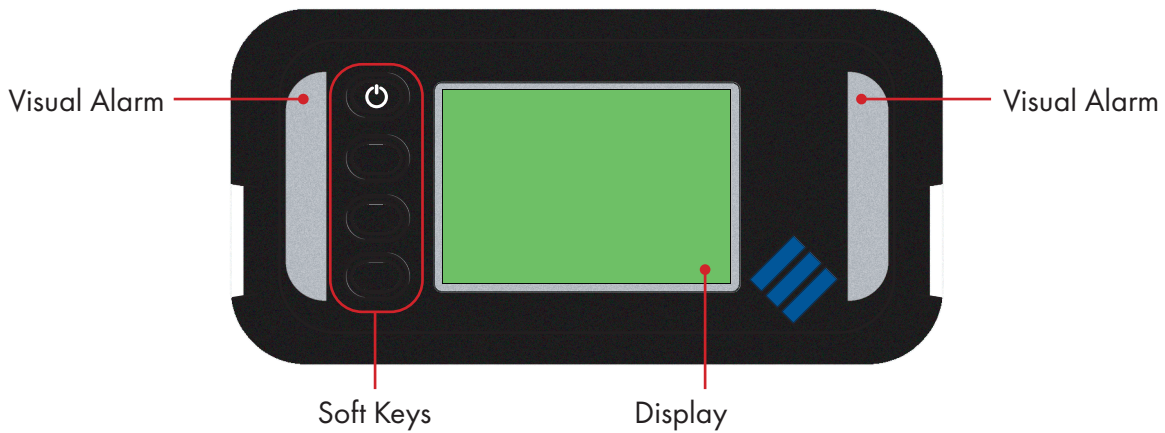

Figure 3: GS700 - Top View

2.6. Display

The GS700 is a fully configurable gas monitor and menu structure or information displayed may vary.

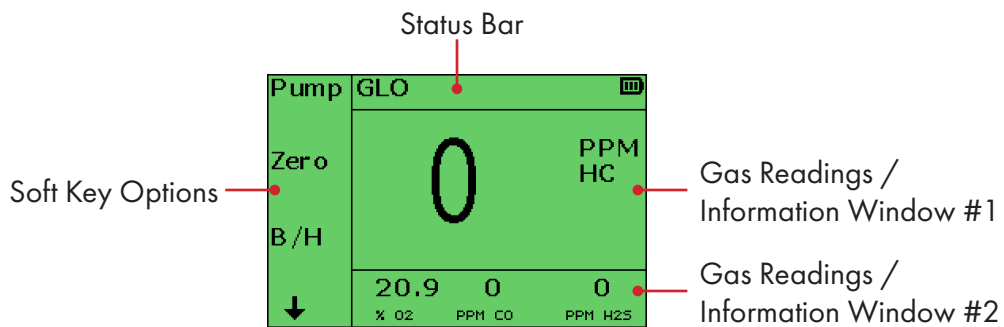

Figure 4: Example Display



Note: [Figure 4](#) will be used throughout this user guide to illustrate the main display.

2.6.1 Soft Keys

The GS700 has 4 soft-keys performing different operations depending on mode and function.

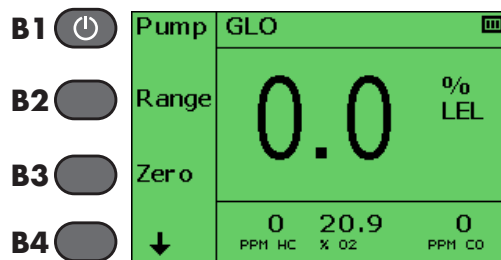

Figure 5: Soft-keys

If no on-screen label is available, the soft-keys will be referred to as **B1**, **B2**, **B3**, and **B4** as shown in [Figure 5: Soft-Keys](#).

2.6.2 Status Bar

This area of the screen informs the user of the current operating mode and displays icons that provide information about monitor status.

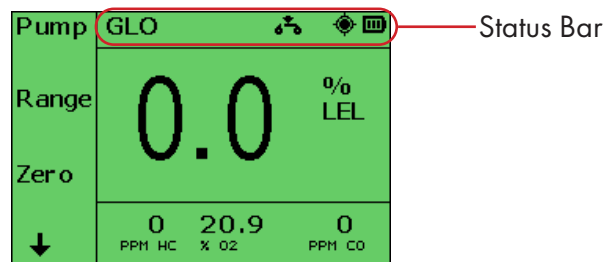









Figure 6: Status Bar

Status bar icons:

	Battery Current battery level.
	Datalogging Datalog is being undertaken (manual or automatic).
	GPS Flashing - the monitor is acquiring a GPS location. Solid - the location of the monitor has been found.
	Pump The pump is operating at high speed.
	Geiger - audible & visual alarms off The audible and visual alarms are switched off when using the Geiger feature in Search mode.
	Geiger - audible alarm on / visual alarm off The audible alarm is active when using the Geiger feature in Search mode.
	Geiger - audible alarm off / visual alarm on Visual alarms are active when using the Geiger feature in Search mode.
	Geiger - audible & visual alarms on The audible and visual alarms are active when using the Geiger feature in Search mode.

3. Operation

3.1. Operating Procedure

Check the following before use:

- The monitor is clean and in good condition.
- The inlet filter is clean and in good condition.
- The sample line and any other accessories to be used are in good condition.
- The batteries are in good condition, charged and fitted correctly.
- The battery indication provides sufficient capacity for the application.
- The monitor is within your calibration period.
- The soundness test is successful.
- All applicable ranges are operational.
- There are no fault indications.

3.2. Quick Configuration Display

This feature allows configuration information to be viewed without fully switching the monitor ON (see [Figure 7: Quick Configuration Display](#)).

With the monitor OFF, press **B2** for one second. The monitor will display:

- Flammable gas calibration.
- List of sensors fitted.
- Due dates (service, calibration, bump).
- Is GPS enabled.

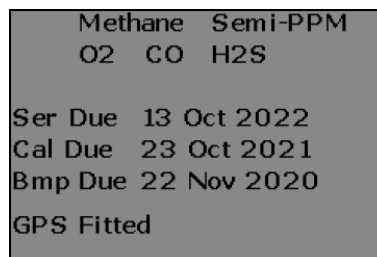

```
Methane Semi-PPM
O2 CO H2S

Ser Due 13 Oct 2022
Cal Due 23 Oct 2021
Bmp Due 22 Nov 2020
GPS Fitted
```

Figure 7: Quick Configuration Display

3.3. Switching the Monitor ON / Warm-up Sequence



WARNING: ALWAYS SWITCH THE MONITOR ON IN FRESH AIR.

Press and hold **B1** for one second to switch the monitor ON (refer to [Figure 5: Soft-Keys](#)). The instrument logo appears (as shown in [Figure 8: Splash Screen](#)) and the monitor begins its warm-up routine.



Figure 8: Splash Screen

3.3.1 Monitor Identification

During warm-up, the serial number, software version and battery status information are listed, as shown in [Figure 9: Warm-up - Monitor ID](#).

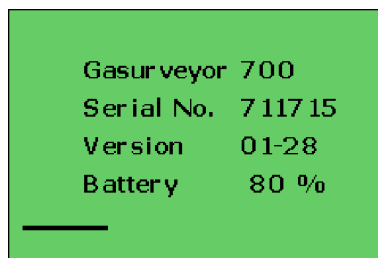

Figure 9: Warm-up - Monitor ID

3.3.2 Date & Time

The time and date are displayed on top of the screen as shown in [Figure 10: Warm-up - Due Dates](#). Verify they are correct, as they are used with datalogging.

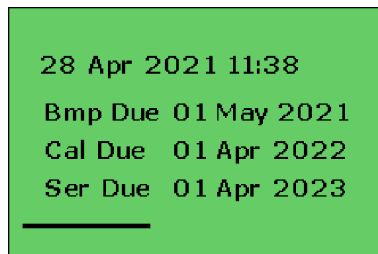

Figure 10: Warm-up - Due Dates

3.3.3 Bump Due Date

Bump Due date is displayed below the Time & Date as shown in [Figure 10: Warm-up - Due Dates](#).

The interval can be set from 1 to 30 days.

This feature can be configured to operate in four ways:

1. Bump Due disabled - no date is displayed. The monitor does not require a valid Bump Test to operate.
2. Bump Due enabled - if overdue, monitor is switched off.
3. Bump Due enabled - if overdue, the monitor warm-up continues automatically.

4. Bump Due enabled - if overdue, user acknowledge is required. As shown in [Figure 11: Warm-up - Bump Overdue](#).

If bump is due, the user must either:

- Press **Continue** for monitor warm-up to continue.
- Press **Switch Off** to switch OFF the monitor.

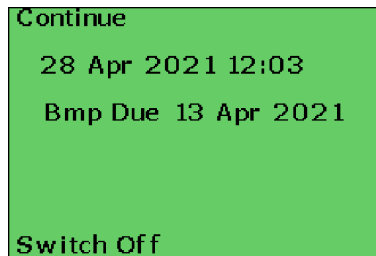

Figure 11: Warm-up - Bump Overdue

3.3.4 Calibration and Service Due Dates

Calibration and Service Due dates are displayed below the Bump Due date as shown in [Figure 10: Warm-up - Due Dates](#).

Calibration Due date can be set from 1 to 400 **days** and Service Due date can be set from 1 to 36 **months**.

The Calibration Due date is automatically updated when all ranges of the monitor are successfully calibrated.

The monitor has five options to alert the user when calibration or service is overdue:

1. Calibration / Service Due disabled - no date is displayed. The monitor does not require a valid calibration or service to operate.
2. Calibration / Service Due enabled - if overdue, monitor is switched off.
3. Calibration / Service Due enabled - if overdue, the monitor warm-up continues automatically.
4. Calibration / Service Due enabled - if overdue, user acknowledge is required. As shown in [Figure 12: Warm-up - Calibration Overdue](#).

If calibration or service is due, the user must either:

- Press **Continue** for monitor warm-up to continue.
- Press **Switch Off** to switch OFF the monitor.

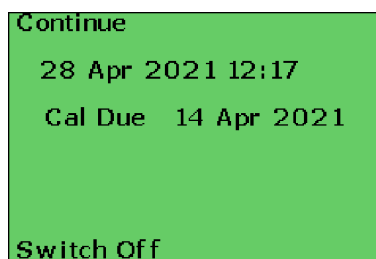

Figure 12: Warm-up - Calibration Overdue

5. Calibration / Service Due enabled - if overdue, user can extend the due date by up to 30 days.

If calibration or service is within the “extended period”, the user must still acknowledge that calibration has expired as shown in [Figure 12: Warm-up - Calibration Overdue](#).

If the extended period has expired, the only option will be to switch the monitor OFF. As shown in [Figure 13: Warm-up - Calibration Overdue \(switch off\)](#).

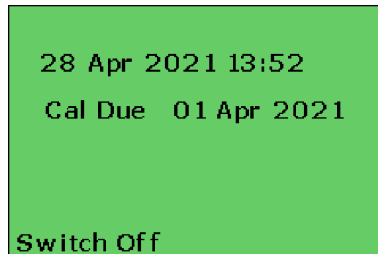

Figure 13: Warm-up - Calibration Overdue (switch off)

3.3.5 Soundness Test

A soundness test verifies the monitor and probe are not leaking.



Note: Soundness Test is an optional feature that can be requested during the monitor procurement. If enabled, the check can be set to operate once a day or with each power-up.

When the Soundness Test screen is displayed (as shown in [Figure 14: Soundness Test](#)), block the gas inlet (sample path) for 5 seconds.

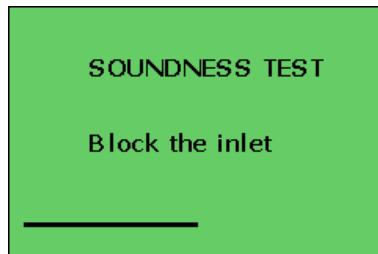

Figure 14: Soundness Test

If the monitor and probe are not leaking the test will pass (as shown in [Figure 15: Soundness Test Pass](#)). Unblock the gas inlet to continue.

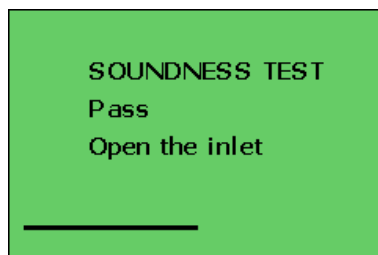

Figure 15: Soundness Test Pass

If a leak is detected in the monitor or probe, the soundness test will fail (as shown in [Figure 16: Soundness Test Fail](#)). Once the leak been rectified, press **Retry** to re-test.

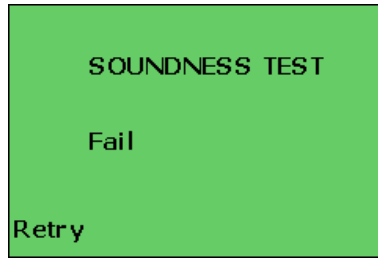

Figure 16: Soundness Test Fail

3.3.6 Alarm Levels

After the Soundness Test is successfully completed, the monitor will report the alarm set-points for each range (e.g. LEL range shown in [Figure 17: Warm-up - Alarm set-points \(LEL\)](#)).

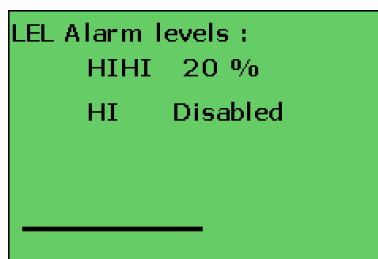

Figure 17: Warm-up - Alarm set-points (LEL)



CAUTION: It is the responsibility of the user to ensure that the alarm set-points are appropriate for the safe operation and legal requirements of the country / industry in which the instrument is being used.



Note: Alarm set-points are configured during the monitor procurement.

3.3.7 Sensors Zero Check

At the end of warm-up, each sensor is zeroed, as shown in [Figure 18: Warm-up - Sensor check](#).

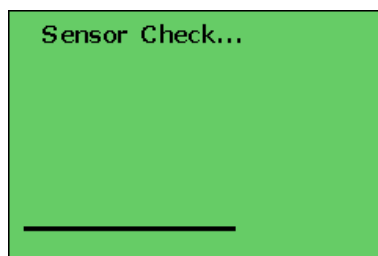

Figure 18: Warm-up - Sensor check

A successful zero check results in a 'tick' symbol against all the monitor's sensors (as shown in [Figure 19: Warm-up - Successful sensor check](#)).

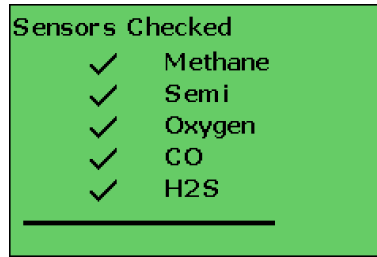

Figure 19: Warm-up - Successful sensor check

A failed zero check results in a **Fault** or **Check** message against the affected range (as shown in [Figure 20: Warm-up - Failed sensor check](#)).

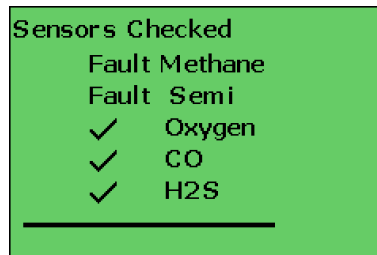

Figure 20: Warm-up - Failed sensor check

If a Zero Fault is detected, the monitor should be restarted in fresh air. If the fault persists, recalibrate the monitor. If that fails, return the monitor to a Teledyne GMI approved service center.



Note: If a Zero Fault exists, the monitor can still be used to detect and alarm on all the other ranges fitted.

3.4. Switching the monitor OFF

To switch off the monitor, press and hold **B1** for 3 seconds. A countdown from 3 to OFF, as shown in [Figure 21: OFF Sequence](#) will begin.

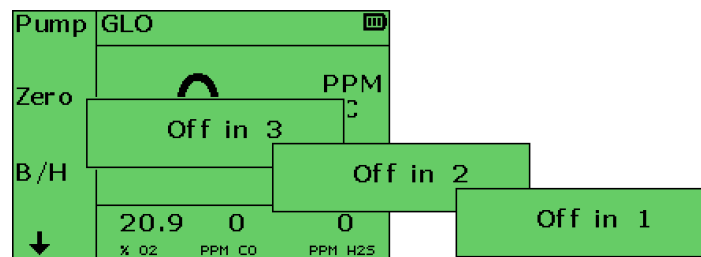

Figure 21: OFF Sequence

4. Modes of Operation

During monitor procurement, the GS700 can be configured to have up to 4 of the following modes of operation:

- Gas Leak Outdoors (GLO) - with optional Barhole testing
- Gas Leak Indoors (GLI)
- Confined Space Monitor (CSM)
- Purge
- Search



Note: Pipeline Gas Test (PGT) is an optional feature. When configured, PGT can be available in all modes of operation, except for CSM.



Note: Mode names and their on-screen sequence can be modified during the monitor procurement.

To change the mode of operation, press the **Mode** button. This will open the mode selection screen as shown in [Figure 22: Mode Selection](#).

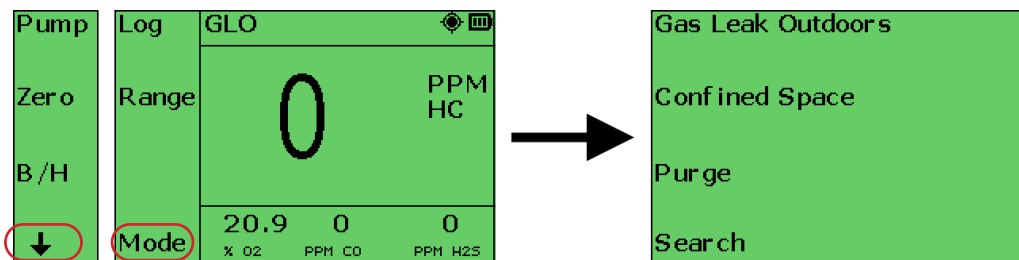

Figure 22: Mode Selection

Once the mode is selected, its short name will be displayed in the status bar (as shown in [Figure 23: Active Mode](#)).

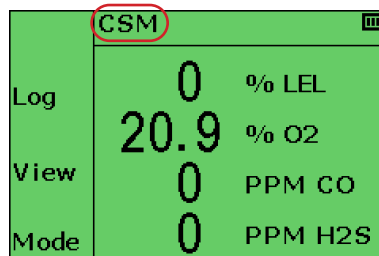

Figure 23: Active Mode



Note: After completed warm-up the monitor automatically selects the mode that is listed as first on the mode selection screen.



Note: Some of the ranges, features and functions described below are optional and may not be available on your monitor.

4.1. Gas Leak Outdoors (GLO) / Indoors (GLI)

In these modes, the GS700 acts as a gas indicator drawing a gas sample, via a probe, where gas is suspected to be present.

4.1.1 Available Ranges

- 0 - 10,000 ppm Methane (*Semiconductor sensor*)
- 0 - 10,000 ppm Flammable (*IR sensor*)
- 0 - 100% LEL Flammable
- 0 - 100% Volume Flammable
- 0 - 25% Volume Oxygen (O₂)
- 0 - 1,000 ppm Carbon Monoxide (CO)
- 0 - 100 ppm Hydrogen Sulphide (H₂S)

4.1.2 Features

Gas Leak Outdoors (GLO) / Indoors (GLI) modes features:

- Barhole testing (*GLO mode only*)
- Audible / visual gas alarms (*optional*)
- Pump control
- Manual & automatic datalogging
- Sensor zeroing
- Flammable autoranging (ppm to LEL to Volume)

4.1.3 Display

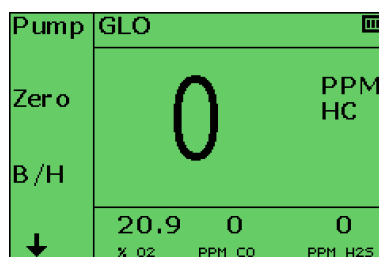
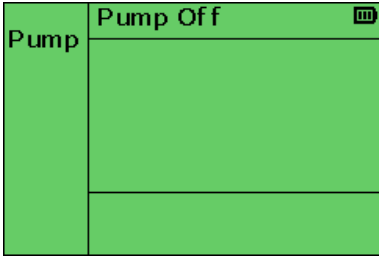
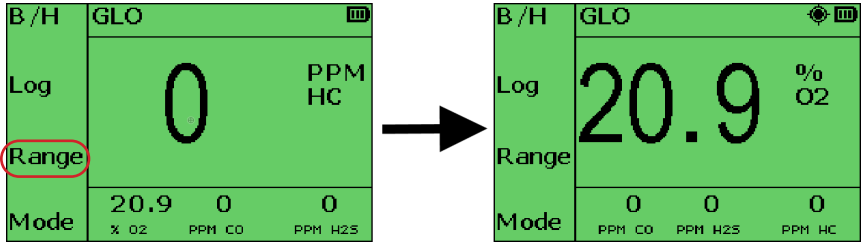

Figure 24: Typical Gas Leak Outdoors (GLO) display

4.1.4 Soft-keys Functions

Button	Action
Pump	Switch the pump ON/OFF.
	Monitor functionality is disabled when the pump is OFF (as shown in Figure 25: Pump OFF).
	
	Figure 25: Pump OFF
Zero ¹	Zero all gas ranges.
B/H	Enter Barhole mode. Refer to Section 4.1.6: Barhole Testing for more details.
PGT	Enter Pipeline Gas Test (PGT) mode. Refer to Section 4.5: Pipeline Gas Test (PGT) for more details.
Log	Perform a manual log of all the monitor readings.
Range	Change the gas range visible on the main section of the display (as shown in Figure 26: Change Range).
	
	Figure 26: Change Range



CAUTION: Always zero the monitor in fresh air.

4.1.5 Logging

By default, automatic datalogging every minute is active for all ranges.

4.1.6 Barhole Testing

Barhole testing is available only in Gas Leak Outdoors (GLO) mode.

Barholes are small holes, inserted in the ground to assist with pin-pointing a gas leak from an underground gas pipe. Readings are obtained by placing a probe into the barhole.

The GS700 stores the following measurements when barhole testing:

- LEL / Volume gas readings (peak and sustained)
- Time & Date
- GPS location



Note: Alarms and pump control are disabled during a barhole test.

To perform barhole testing:

1. Ensure mode is Gas Leak Outdoor (GLO).
2. Press **B/H** button (as shown in [Figure 27: B/H button](#))

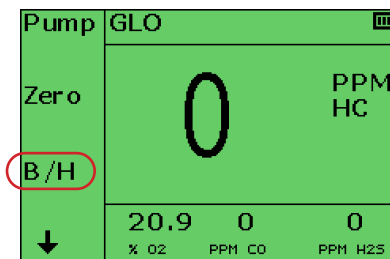

Figure 27: B/H button

3. Press **Yes** button to start new series of readings.
Press **No** button to continue with a previous series.

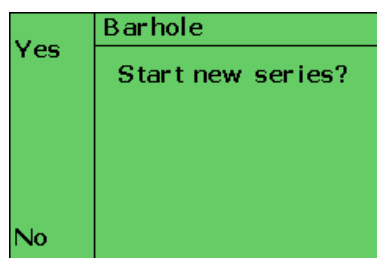

Figure 28: Barhole - Screen 1

Yes button clears the current barhole series and starts new one with 'Barhole number 01' on the next screen (as shown in [Figure 29: Barhole - Screen 2](#)).

No button will keep the existing data. The next screen will display the next barhole number without data (as shown in [Figure 30: Barhole - Screen 3](#)).



Note: Each series can store up to 25 barhole numbers.

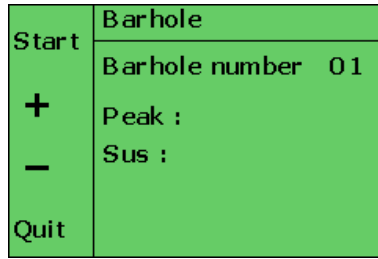

Figure 29: Barhole - Screen 2

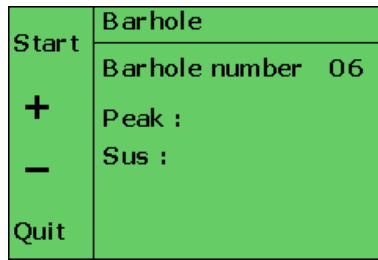

Figure 30: Barhole - Screen 3

4. Press **Start** button to initiate barhole test.
Press **+** or **-** buttons to browse the barhole numbers.
Press **Quit** button to return to Gas Leak Outdoor (GLO) main screen.
5. Once the barhole test is initiated, a timer will commence and the gas reading will be displayed (as shown in [Figure 31: Barhole - Screen 4](#)). After sampling is completed, the peak and sustained readings are displayed as shown in [Figure 32: Barhole - Screen 5](#).



Note: Barhole sampling time can be set during the monitor procurement (from 10s to 60s). By default, this value is set to 15 seconds.

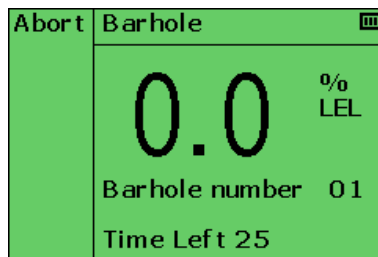

Figure 31: Barhole - Screen 4

Test can be aborted at any time by pressing the **Abort** button.

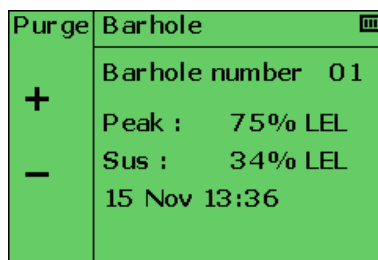

Figure 32: Barhole - Screen 5

- After sampling is complete, there is a purge that removes any residual gas from the monitor before the next barhole can be sampled.

Press **Purge** button to initiate the purge process.

Press **+** or **-** buttons to view the results of other barhole tests.



Note: Purging will continue until the gas reading is less than 2% LEL at which point a 10s count-down timer starts (as shown in [Figure 33: Barhole - Purge](#)).

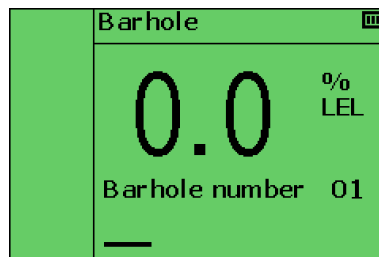

Figure 33: Barhole - Purge

- Once the purge is complete, the Barhole Testing main menu will be displayed with the next available barhole number (as shown in [Figure 30: Barhole - Screen 3](#)).

To repeat (overwrite) a barhole test:

- Navigate to the barhole test you wish to repeat using **+** and **-** buttons.
- Press **Start** button to initiate the test.
- An overwrite confirmation screen will appear (as shown in [Figure 34: Barhole - Overwrite](#)). Press **Yes** button to continue with the barhole test or **No** to return to previous screen.

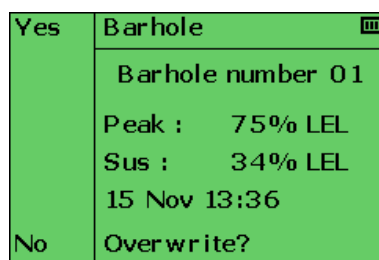

Figure 34: Barhole - Overwrite

- Continue with the barhole test as previously described.

4.2. Confined Space Monitor (CSM)

In this mode, the GS700 acts as a safety monitor for use when entering confined spaces which may contain hazardous gas mixtures.



Note: In the CSM mode the pump runs continuously for safety reasons.

4.2.1 Available Ranges

- 0 - 100% LEL Flammable
- 0 - 25% Volume Oxygen (O₂)
- 0 - 1,000 ppm Carbon Monoxide (CO)
- 0 - 100 ppm Hydrogen Sulphide (H₂S)

4.2.2 Features

Confined Space Monitor mode features:

- Audible / visual gas alarms
- Manual & automatic datalogging
- Confidence signal
- Gas readings & alarm set-points viewer

4.2.3 Display

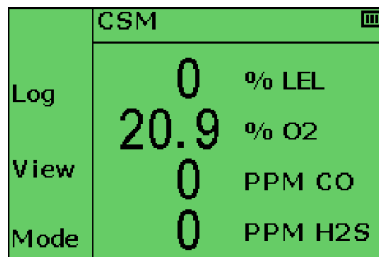

Figure 35: Typical Confined Space Monitor (CSM) display

4.2.4 Soft-keys Functions

Button	Action
Log	Perform a manual recording of all the monitor readings.
View	Open gas readings & alarm set-points viewer. Refer to Section 4.2.6: Gas Readings & Alarm Set-points Viewer for more details.



Note: For safety reasons, the monitor cannot be zeroed in the CSM mode.

4.2.5 Logging

By default, automatic datalogging every minute is active for all ranges.

4.2.6 Gas Readings & Alarm Set-points Viewer

In CSM mode, the monitor records the maximum (Max) and minimum (Min) gas values, as well as the short-term (STEL) and long-term (LTEL) exposures for CO and H₂S.

To view the recorded values:

1. From the normal operating display, press the **View** button once to open the viewer. Maximum (Max) gas readings will be displayed.
2. Press **Next** button to circulate between following:
 - Maximum gas values (*Max*)
 - Minimum gas values (*Min*)
 - Current STEL exposure (*STEL*)
 - Current LTEL exposure (*LTEL*)
 - HiHi alarm set-points (*HiHi Alm*)
 - Hi & Lo alarm set-points (*Hi/Lo Alm*)
 - LoLo alarm set-points (*LoLo Alm*)
 - STEL alarm set-points (*STEL Alm*)
 - LTEL alarm set-points (*LTEL Alm*)
 - Live readings (*CSM*)

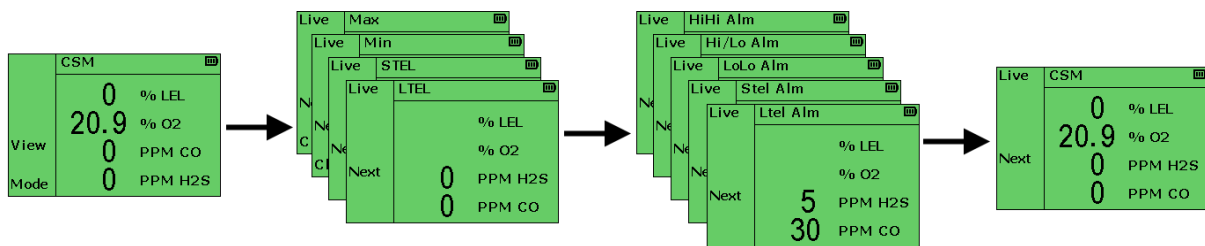

Figure 36: CSM - Gas Readings & Alarm Set-points Viewer

Press the **Clear** button to re-sets the Maximum and Minimum values back to 0.

3. Press **Live** button to return to normal operating display.



Note: If no buttons are pressed, the display will automatically return to the normal operating display (live) after 5 seconds.

4.3. Purge

In this mode, the GS700 aids in the purging of pipework installations.

4.3.1 Available Ranges

- 0 - 100% Volume Flammable
- 0 - 25% Volume Oxygen (O₂)

4.3.2 Features

Purge mode features:

- Audible / visual alarms for oxygen range (*optional*)
- Pump control
- Manual & automatic datalogging
- Sensor zeroing

4.3.3 Display

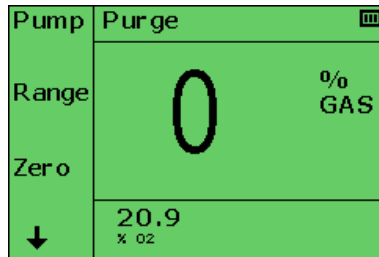
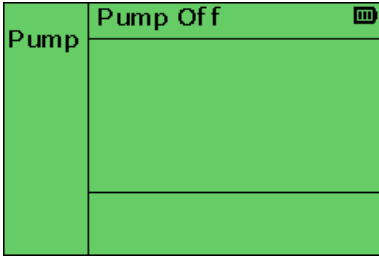

Figure 37: Typical Purge display

4.3.4 Soft-keys Functions

Button	Action
Pump	Switch the pump ON/OFF. Monitor functionality is disabled when the pump is OFF (as shown in Figure 38: Pump OFF).
	 <p>Figure 38: Pump OFF</p>
Zero¹	Zero all gas ranges.
PGT	Enter Pipeline Gas Test (PGT) mode. Refer to Section 4.5: Pipeline Gas Test (PGT) for more details.
Log	Perform a manual recording of all the monitor readings.

Range

Change the gas ranges visible on the main section of the display (as shown in [Figure 39: Change Range](#)).

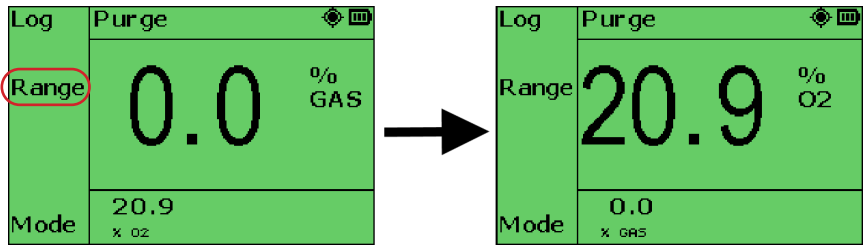

Figure 39: Change Range



CAUTION: Always zero the monitor in clean atmosphere.

4.3.5 Logging

By default, automatic datalogging every minute is active for all ranges.

4.4. Search

In this mode, the GS700 is used for rapid leak detection.



Note: Search mode is only available for monitors equipped with the PPM Flammable range.

4.4.1 Available Ranges

- 0 - 10,000 ppm Methane (*Semiconductor sensor*)
- 0 - 10,000 ppm Flammable (*IR sensor*)
- 0 - 100% LEL Flammable

4.4.2 Features

Search mode features:

- Audible / Visual PPM Ticker (Geiger) alarm
- Fast pump
- Manual & automatic datalogging
- Sensor zeroing
- Flammable autoranging (ppm to LEL to Volume)

4.4.3 Display

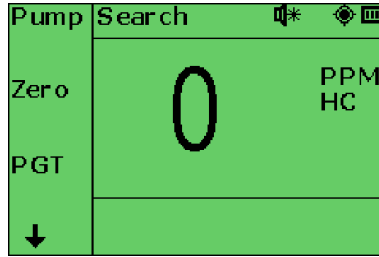

Figure 40: Typical Search display

4.4.4 Soft-keys Functions

Button	Action
Pump	<p>Toggle the pump between normal speed / high speed / OFF.</p> <p>Monitor functionality is disabled when the pump is OFF (as shown in Figure 41: Pump OFF).</p>
	<p>Figure 41: Pump OFF</p>
Zero ¹	<p>Zero all gas ranges.</p>
PGT	<p>Enter Pipeline Gas Test (PGT) mode. Refer to Section 4.5: Pipeline Gas Test (PGT) for more details.</p>
Log	<p>Perform a manual recording of all the monitor readings.</p>
A/V	<p>Change the operation of the Ticker (Geiger) alarm. Refer to Section 2.6.2: Status Bar for more details.</p>

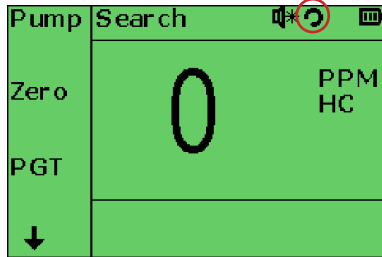

Figure 42: High Speed Pump



CAUTION: Always zero the monitor in fresh air.

4.4.5 Logging

By default, automatic datalogging is active and being performed every 4 seconds.

4.5. Pipeline Gas Test (PGT)

Pipeline Gas Test is used to discriminate between methane and other hydrocarbons. It can quickly determine if the source of gas leaks is from pipeline gas or is naturally occurring biogas.

PGT can be configured to be available in all modes of operation, except for CSM.



Note: PGT mode requires an additional 10-minute warm-up after powering up the monitor. During that time the PGT will flash and the feature won't be accessible.



Note: This chapter describes the Pipeline Gas Test functionality for instrument firmware v1.30 (or later). Please see [Appendix A: Pipeline Gas Test \(pre firmware v1.30\)](#) for details on how to use PGT on older GS700 units.

To access the PGT and perform the test:

1. From the normal operating display, press the **PGT** button. This opens the PGT menu as shown in [Figure 42: PGT Menu](#).

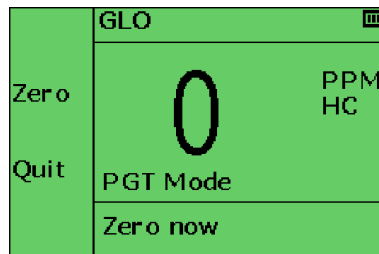

Figure 42: Access Menu

2. Press **Zero** button to zero the flammable ranges and begin sampling. This will initiate a 5-minute countdown (as shown in [Figure 43: PGT Sampling](#)) during which time the gas leak survey should take place.

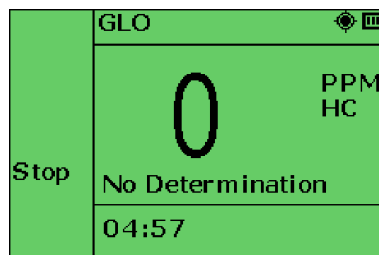

Figure 43: PGT Sampling



CAUTION: Always zero the monitor in clean atmosphere.

3. After the monitor has made a discrimination, the decision is displayed as shown in [Figure 44: PGT Discrimination](#).



Figure 44: PGT Sampling



Note: The 'Methane Only!' and 'Other Hydrocarbons' messages can be changed during the monitor procurement.

Note: GS700 will indicate if the gas sample is Methane or other hydrocarbons, providing:



- The measured sample is >1% Volume Gas
- The sample source contains a minimum of 2% Ethane

Decision point will improve with increased concentration of heavier hydrocarbons in measured mixture (e.g. 5% of Ethane will bring the decision point to 0.5% Vol).

4. Continue the survey until the countdown is complete or press the **Stop** button.
5. After sampling is completed, the Peak reading is displayed as shown in [Figure 45: PGT Results](#).

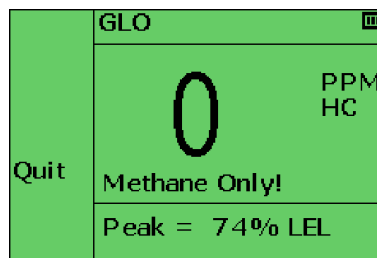

Figure 45: PGT Results

6. Press the **Quit** button to return to normal operating screen.



Note: Each completed PGT session is recorded in the instrument datalogger.

5. Alarms

Alarm set-points (instantaneous, STEL and LTEL) are set during the monitor procurement. It is important to verify that the set-points are in accordance with your company's requirements and with local health and safety legislation.

When the measured gas levels go above or below (oxygen) the instrument alarm set-points, the following alarms may be triggered:

- Audible - buzzer will sound (tone will differ depending on alarm type).
- Visual - 360° LED bar and top cover LED's will flash red (flash will differ depending on alarm type).
- Display - backlight turns red and alarm flags are displayed.



Figure 46: Alarm Indicators

5.1. Instantaneous Gas Alarms

When an alarm set-point has been reached, the audible and visual alarms will activate to alert the user.

- Alarms only operate once the monitor warm-up is complete.
- All gas alarms are set during the monitor procurement to meet the specific needs of the user.

Refer to the table of [Available Gas Alarms](#) table for more details.



Note: Instantaneous Gas Alarms are not available in Search mode.

5.2. Time-averaged Toxic Gas Alarms

In the Confined Space Monitor (CSM) mode the monitor also calculates the Short-Term and Long-Term Exposures for toxic gas ranges. If these exceed the STEL or LTEL then alarms are activated.



Note: A time-averaged value is the mean average gas level over a rolling period. The STEL is 15 minutes and the LTEL/TWA is 8 hours. In accordance with legislation, this requires the time weighted averages to be averaged over a full period whether the monitor is ON or OFF. Such averaging essentially makes the monitor single user applicable.



Note: Because readings are averaged, it is possible to get a 'live reading' of zero and have a LTEL or STEL alarm active.

5.3. Ticker (Geiger) Gas Alarm

An audible and visual Geiger alarm, enabled in the PPM Flammable range, provides indication of increasing or decreasing gas concentration via a variable rate sounder and LED flashes.

User can change the operation of the Ticker (Geiger) alarm. Refer to [Section 2.6.2: Status Bar](#) for more details.



Note: Ticker (Geiger) gas alarm is available only in Search mode.

5.4. Available Gas Alarms

	Modes			
	GLO / GLI	CSM	Purge	Search
Instantaneous alarms	✓ Non Latching	✓ Latching	✓ Non Latching	
Time-averaged alarms		✓ Latching		
Ticker (Geiger)				✓

5.5. Gas Alarms Examples

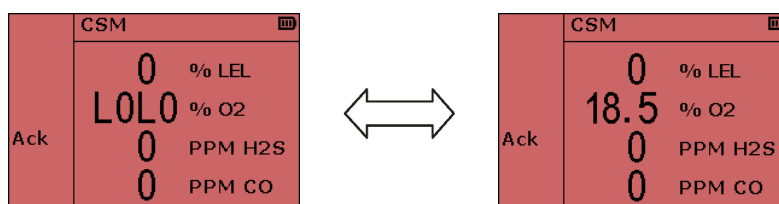

Figure 47: LOLO Oxygen Alarm

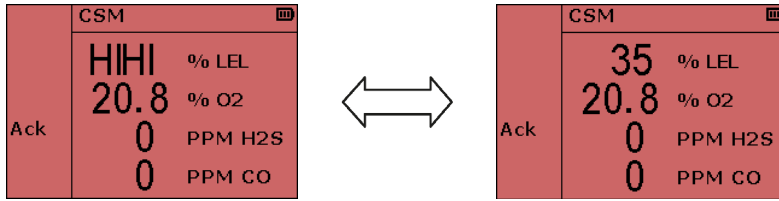

Figure 48: HIHI LEL Alarm

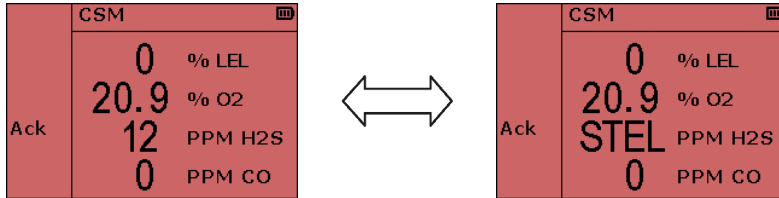

Figure 49: STEL H₂S Alarm

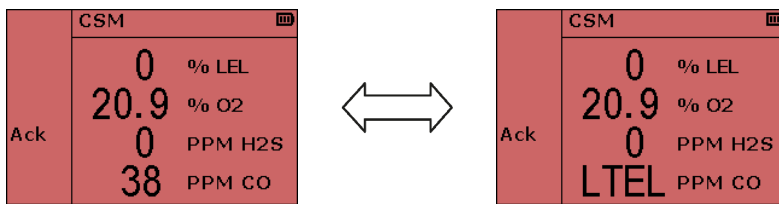

Figure 50: LTEL CO Alarm

5.6. Gas Alarm Options

5.6.1 Alarm Intensity

In Gas Leak Indoors, Gas Leak Outdoors and Purge modes user can choose different intensities for the instantaneous alarms. This is selected during the monitor procurement.

Available options:

Low intensity:

- alarm flags



Medium intensity:

- alarm flags
- red display backlight
- top cover LEDs



High intensity:

- alarm flags
- red display backlight
- top cover LEDs
- 360° LED bar
- audible alarm





Note: In Confined Space Monitor (CSM) mode alarms are always set to high intensity.

5.6.2 Latching / Non Latching

In Confined Space Monitor (CSM) mode alarms are individually programmable to be either latching or non-latching:

- Latching - alarms can only be reset once gas readings have returned to a safe level. To reset, press and hold the **Ack** button.
- Non-Latching - alarms will automatically reset when the gas readings have returned to a safe level.

5.6.3 Muting

In Confined Space Monitor (CSM) mode, the audible alarm can be muted for 60 seconds. However, the visuals and displayed alarm flag will remain active. After 60 seconds the audible alarm will reactivate.

When the audible alarm is muted and gas levels fall below the alarm set-points:

- Latching alarm - the visual / displayed alarms can be cleared by pressing the **Ack** button.
- Non-latching alarm - the visual / displayed alarms clear automatically.

5.7. Warnings & Fault Alarms

5.7.1 Confidence Signal

The confidence signal is an audible (beep) and visual indication (green LEDs on the 360° LED bar), every 10 seconds, that the monitor is operating correctly. The confidence signal is available only in the Confined Space Monitor (CSM) mode.

5.7.2 Battery Warning

The 'Low Bat' message will flash on the display when approximately 30 minutes of runtime remain (as shown in [Figure 51: Low Bat](#)). Recharge the monitor or replace the alkaline batteries.

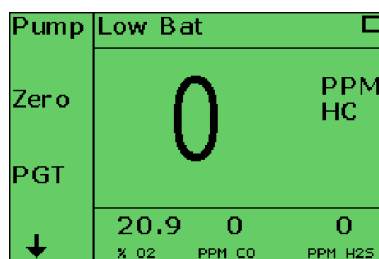

Figure 51: Low Bat

5.7.3 Over-range Alarm

In the event of the flammable gas sensor being exposed to a high concentration of flammable gas, the instrument has an over-range alarm.

- In Confined Space Monitor (CSM) mode if the LEL sensor is exposed to gas above 100% LEL, EEE will alternate with the HIHI alarm flag (as shown in [Figure 52: Over-range in CSM](#)).

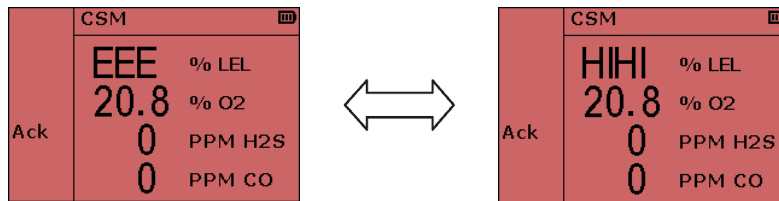

Figure 52: Over-range in CSM

- In Gas Leak Indoor, Gas Leak Outdoor and Search modes if the PPM sensor is exposed to a gas reading above 10,000 ppm and no autoranging for the flammable range is enabled, EEEE flag will appear as shown in [Figure 53: Over-range in GLO](#).

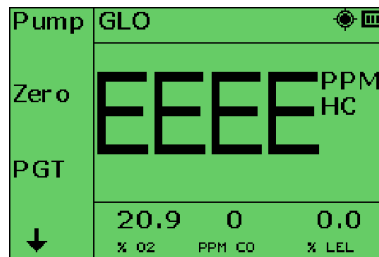

Figure 53: Over-range in GLO

5.7.4 Zero Fault

If the monitor is switched on in gas and unable to zero all sensors correctly:

- A flashing 'Zero' alarm flag alternates on the display with the gas range.
- The audible alarm sounds, and the red 360° LED bar flashes.

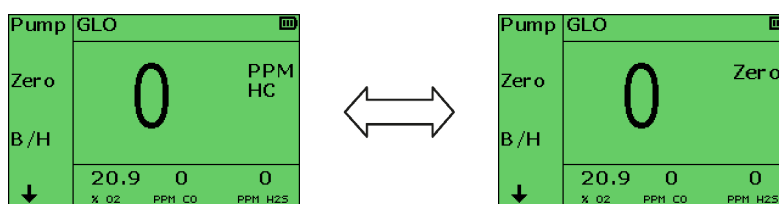

Figure 54: Zero Fault

Return the monitor to fresh air and then press **Zero** button. If the fault persists, return the monitor for service.



Note: If a Zero Fault exists, the monitor can still be used to detect and alarm on all the other ranges fitted

5.7.5 Sample Fault

If a sample fault exists:

- Monitor functionality is disabled and 'Sample fault' flashes on screen (as shown in [Figure 55: Sample Fault](#)).
- Audible alarm activates.
- Top cover LED flash.
- Red display backlight activates.

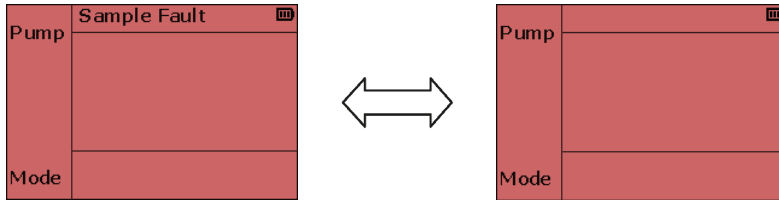

Figure 55: Sample Fault

Check sample line, filter, or probe for blockage. Clear blockage, then restart pump by pressing the **Pump** button.



Note: In Confined Space Monitor (CSM) mode, once the blockage is cleared, the pump will restart automatically.

6. Operator Maintenance

6.1. Replacing Alkaline Batteries



WARNING: BATTERIES MUST BE CHANGED ONLY IN A LOCATION KNOWN TO BE NON-HAZARDOUS.



WARNING: DO NOT MIX NEW BATTERIES WITH USED BATTERIES OR MIX BATTERIES FROM DIFFERENT MANUFACTURERS.



WARNING: DO NOT USE RECHARGEABLE BATTERIES.



WARNING: TO PREVENT IGNITION OF FLAMMABLE OR COMBUSTIBLE ATMOSPHERES, ALWAYS REMOVE BATTERIES BEFORE SERVICING THE MONITOR.



WARNING: TO PREVENT IGNITION OF FLAMMABLE OR COMBUSTIBLE ATMOSPHERES, READ, UNDERSTAND AND ADHERE TO THE MANUFACTURER'S MAINTENANCE PROCEDURES.

1. Using the 4mm hex driver (supplied), loosen the 2 base screws.



Figure 56: Battery Cover Removal

2. Remove the battery cover.



Figure 57: Battery Cover Removal

3. Remove the old batteries.
4. Check battery compartment for damage to spring contacts or corrosion on springs.
5. Insert the 3 new batteries observing correct polarity. Polarity markings are indicated in the battery compartment.



Figure 58: Battery Compartment

6. Replace battery cover and fasten the base screws.

6.2. Recharging the Battery Pack

The Lithium-Ion battery pack is recharged using a dedicated Teledyne GMI charger. The battery pack can be charged fitted to the monitor or separately.



Figure 59: Monitor Charger



WARNING: BATTERY PACKS MUST BE CHARGED ONLY IN A LOCATION KNOWN TO BE NON-HAZARDOUS.



WARNING: ONLY USE TELEDYNE GMI APPROVED CHARGER.



Note: It can take up to 9 hours to fully charge the battery pack.

6.2.1 Charging the Monitor

1. Ensure the monitor is switched OFF and charger is switched ON (indicated by the green power LED).
2. Place the monitor into the charging cradle, as shown in [Figure 60: Monitor Charging](#).



Figure 60: Monitor Charging



Note: The alignment position of the monitor is moulded on the surface of the charger cradle.



3. The charging icon on the monitor will flash until fully charged.

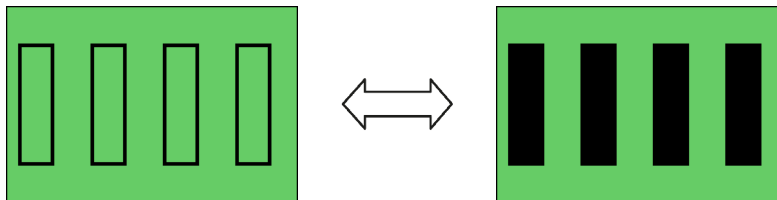

Figure 61: Charging Icon

4. Once charged, remove the monitor from charger, as shown in [Figure 62: Monitor Charging](#).



Figure 63: Monitor Charging

6.2.2 Replacing / Charging the Battery Pack

1. Using the 4mm hex driver (supplied), loosen the 2 base screws and remove the battery pack.



Figure 64: Battery Pack Removal

2. Remove the battery pack.



Figure 65: Removed Battery Pack

3. Ensure the battery charger is switched ON (indicated by the green power LED).
4. Place the battery pack into the charging cradle, as shown in [Figure 66: Battery Pack Charging](#).



Figure 66: Battery Pack Charging

5. The orange LED on the battery pack indicates the battery pack is charging (as shown in [Figure 67: Battery Pack LED](#)). When the LED switches off, the battery pack is fully charged.



Figure 67: Battery pack LED

6. Once charged, remove the battery pack from charger, as shown in [Figure 68: Battery Pack Charging](#).



Figure 68: Battery Pack Charging

7. Re-fit the battery pack to the monitor and fasten the base screws.

6.3. Cleaning

An optical cloth **MUST** be used to clean the display window to prevent scratches. In extreme cases, a mild screen solution may be used with the optical cloth to remove stubborn stains.

The outer casing of the monitor may be cleaned using a non-abrasive damp cloth. Rub the cloth over the outer casing to remove any dirt and grime. In extreme cases, a mild soap solution may be used with a non-abrasive cloth to remove stubborn marks.



Caution: Do not use agents containing silicon or solvent to clean the monitor as these may damage the flammable gas sensor.

Caution: Do not use abrasive materials or strong volatile chemical solutions as these could damage the impact resistant casing.

6.4. Replacing the Filters

The monitor and probe are fitted with various filters. These protect the monitor from the ingress of dust and moisture. The filters are located in the probe handle and in the monitor inlet nozzle and must be inspected periodically for contamination or damage.



WARNING: A LEAK CHECK MUST BE PERFORMED AFTER ANY FILTER REPLACEMENT.

6.4.1 Probe Handle Filter Replacement

Hydrophobic and cotton particulate filters in the probe handle minimise the ingress of water and dust.



Note: When replacing the hydrophobic filter, you must also replace the dust filter.

To replace the filter(s):

1. Unscrew the probe handle assembly.
2. Remove the cotton particulate filter and discard.
3. Remove the hydrophobic filter.
4. Clean the probe handle to make sure it's free from dirt and water.
5. Fit a new cotton particulate filter.
6. Fit the new hydrophobic filter. The filter's yellow label should face the yellow label on the probe handle.
7. Reassemble the probe handle.

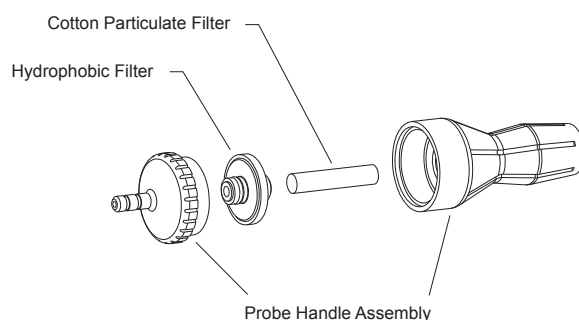

Figure 69: Probe Handle Assembly

6.4.2 Inlet Nozzle Dust Filter Replacement

To replace the instrument dust filter:

1. Using a small coin or flat bladed screwdriver, remove the inlet nozzle.



Figure 70: Inlet Nozzle Removal

2. Remove the dust filter from the inlet nozzle.

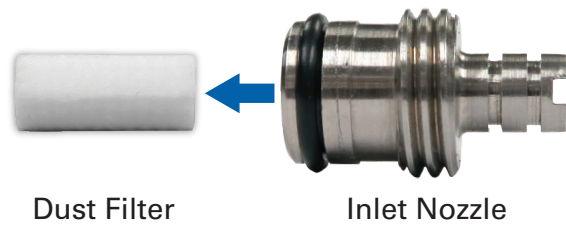

Figure 71: Inlet Nozzle

3. Clean the inlet nozzle to make sure it's free from dirt and water.
4. Fit a new dust filter into the inlet nozzle.
5. Reassemble the monitor.



Note: Do not overtighten the inlet nozzle.



Caution: The monitor must never be switched on without the inlet nozzle installed.

6.5. Screen Contrast Adjustment

1. Press and hold **B1** for one second to switch the monitor ON.
2. Press **B4** immediately after the splash screen appears.
3. Contrast adjustment menu will appear after the initial monitor warm-up (as shown in [Figure 72: Contrast Adjustment Menu](#)).

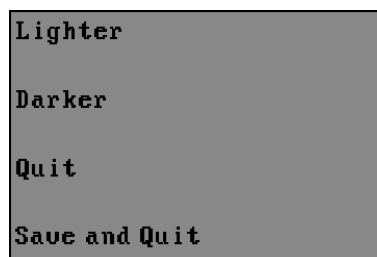

Figure 72: Contrast Adjustment Menu

Press **Lighter** button to reduce the contrast.

Press **Darker** button to increase the contrast.

Press **Quit** button to exit the contrast adjustment menu without saving the changes.

Press **Save and Quit** to save changes and exit the contrast adjustment menu.

7. Bump Test

A bump test verifies sensor response and alarm operation by exposing the monitor to a known concentration of gas.

There are three bump test options:

- Manual (LEL-only test) - using the monitor's Bump Test feature (*recorded in the instrument's datalogger to meet CSA requirements*)
- Manual (all ranges) - direct application of gas while in normal operating mode (*not recorded in the instrument datalogger*)
- Automatic - using a GDUnet station (standalone, PC or IMS modes)

7.1. Manual Bump Test (LEL only)



Note: LEL-only Bump Test is an optional feature that can be enabled during the monitor procurement.



Note: LEL-only Bump Test limits can be adjusted during the monitor procurement (default settings are 40% to 60% LEL). It is the user's responsibility to ensure these are correct.

To perform LEL-only Bump Test:

1. Switch instrument on using **B4**. 'LEL Bump' message will appear on the splash screen (as shown in [Figure 73: LEL Bump Startup](#)).



Figure 73: LEL Bump Startup

2. When warm-up is complete, the LEL Bump Test screen appears and a 60-second countdown begins (as shown in [Figure 74: LEL Bump Counter](#)).

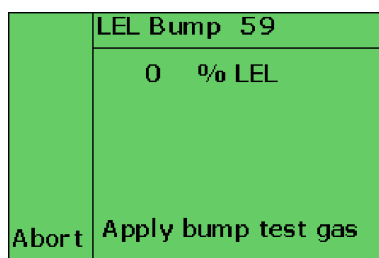

Figure 74: LEL Bump Counter

3. Connect the calibration gas to the monitor inlet (as shown in [Figure 75: Connect Calibration Gas](#)).

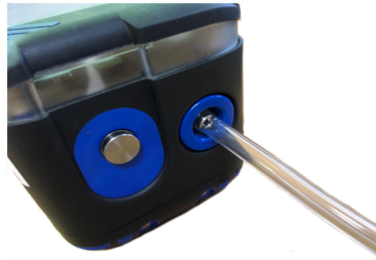

Figure 75: Connect Calibration Gas



Note: Calibration gas shall be delivered to the monitor at ambient pressure. Application of pressurised mixture will result in 'Sample Fault' alarm. Use of a On-Demand Flow Regulator is recommended.

4. Once the measured gas concentration reach the LEL Bump Test limits, the countdown timer automatically resets to 5 seconds and **Pass** appear on the screen (as shown in [Figure 76: LEL Bump - Gas Detected](#)). Keep the gas connected for the full 5 seconds.

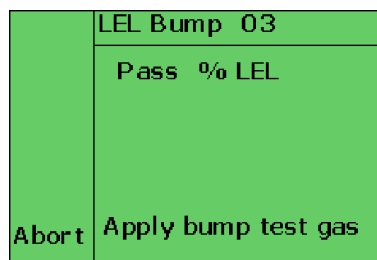

Figure 76: LEL Bump - Gas Detected

If the gas concentration is within the set limits after the 5-second countdown, the bump test is successful and **Purge to air** appears on the display as shown in [Figure 77: LEL Bump Pass](#).

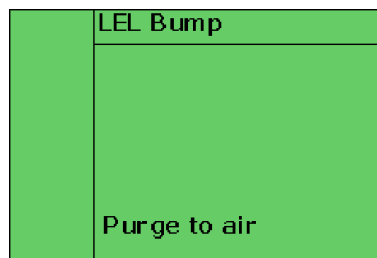

Figure 77: LEL Bump Pass

If the gas concentration is outside the set limits after the 5-second countdown, the bump test has failed. **Failed - Switch off** appear on the display as shown in [Figure 78: LEL Bump Fail](#) and the monitor will shut-down.

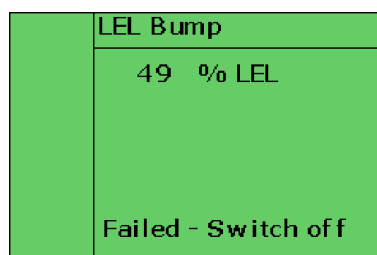

Figure 78: LEL Bump Fail

5. Disconnect the calibration gas from the monitor. When the gas concentration drops below 10% LEL, the monitor returns to the normal operating screen.

CAUTION: The infrared sensor fitted in the GS700 is used for measuring all three flammable gas ranges: ppm, LEL and Volume. Testing with the LEL calibration gas validates both the response and accuracy of the LEL range and response only of the ppm and Volume ranges.



It is the user's responsibility to ensure that any local legal regulations (including internal company procedures), does not require all ranges of the instrument to be individually tested. In this case, it is recommended to perform the test described in [Section 7.2: Manual Bump Test \(all ranges\)](#).

7.2. Manual Bump Test (all ranges)

To perform manual Bump Test:

1. Switch monitor on and allow warm-up to complete. Select an operating mode that displays all instrument ranges. Validate all readings on screen are indicating 0 (or 20.9% for O₂).
2. Connect the calibration gas to the monitor inlet (as shown in [Figure 79: Connect Calibration Gas](#)).

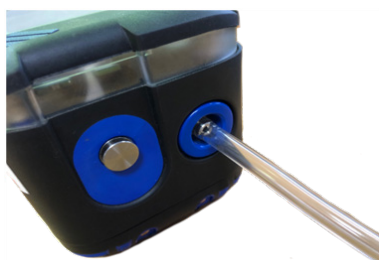

Figure 79: Connect Calibration Gas



Note: Calibration gas shall be delivered to the monitor at ambient pressure. Application of pressurised mixture will result in 'Sample Fault' alarm. Use of a On-Demand Flow Regulator is recommended.

3. Wait for readings to stabilize.

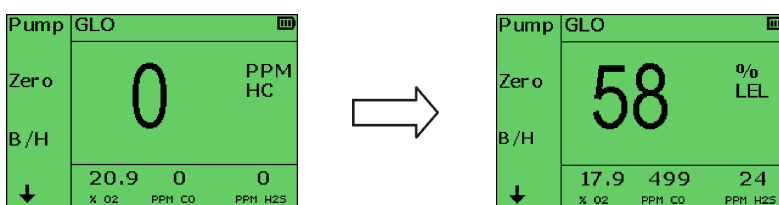

Figure 80: Bump Test - Applying Gas

4. Ensure the value displayed matches the concentration of the calibration gas.



Note: Displayed readings to be within the organisation's internal regulations and/or local legislation.

5. Disconnect the calibration gas from the monitor and allow the readings to return to 0.

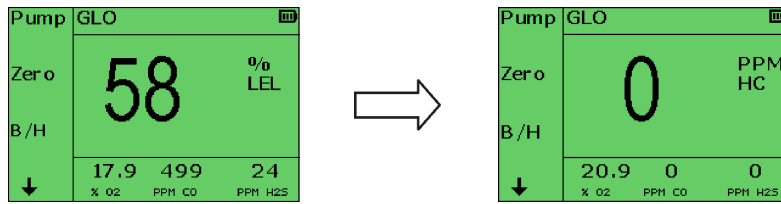

Figure 81: Bump Test - Purge

Note: The following gas concentrations are suggested if no other requirements are specified by local regulations and/or internal company procedures:



- Flammable ppm 4550ppm
- Flammable %LEL 50% LEL
- Flammable Volume 100% Volume
- Oxygen 18% Volume
- Carbon Monoxide (CO) 500ppm
- Hydrogen Sulphide (H₂S) 50ppm

7.3. Automatic Bump Test

For details on automatic bump testing using the GDUnet station, please refer to the following documents:

- [GDUnet User Handbook](#) - part no. 14765
- [FlexiCal Plus User Handbook](#) - part no. 99551



Figure 82: GDUnet Station

8. Calibration

The monitor has been calibrated for particular gases. Where any doubt exists, return the monitor to an authorized distributor for calibration.



WARNING: ONLY AUTHORIZED PERSONNEL MAY CALIBRATE THE MONITOR.

Three methods of calibration are possible:

- Field - using the monitor's Field Calibration feature.
- Manual - using FlexiCal Plus software.
- Automatic - using GDUnet station or FlexiCal Plus software.

8.1. Calibration Validity

Calibration validity is the responsibility of the user. Under normal operating conditions, a 12 month period can be expected. However this is not guaranteed, as the precise application of the product is unknown to Teledyne GMI. Individual codes of practice may dictate shorter periods.

Regular checking establishes a pattern of reliability and enables the calibration check to be modified in line with operational experience. The higher the risk, the more frequently the calibration should be checked.

8.2. Field Calibration



Note: Field Calibration is an optional feature that can be enabled during the monitor procurement.

This feature allows simple calibration in the field without the use of the automatic and manual calibration set-ups.

The following is required to perform field calibration:

- Calibration test gases
- Demand flow regulator
- Sample tubing

To perform field calibration:

1. If a field calibration mode is available, the **FC** symbol will flash on the information screen. Press **B4** to start the process.

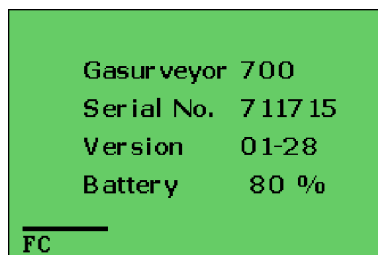

Figure 83: Field Calibration Icon

- After the monitor warm-up is completed, if prompted, enter the field calibration code. The default code is **4343 (B4, B3, B4, B3)**.

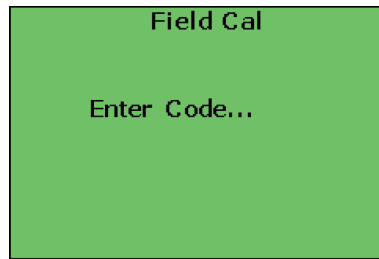

Figure 84: Field Calibration Code



Note: The 4 digit field calibration code can be selected during monitor procurement.

- Apply clean air to the monitor, then press **Zero** button.

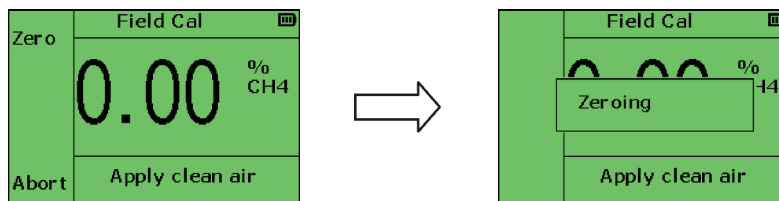

Figure 85: Field Calibration Zero

- Once zeroing is complete, the monitor will display the main field calibration screen (as shown in [Figure 86: Field Calibration](#)).

By default, the first gas range displayed is %Volume Flammable. Press **Range** button to change the displayed range.

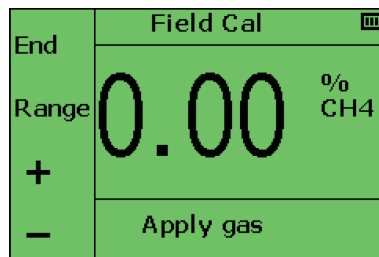

Figure 86: Field Calibration

- Connect the calibration gas to the monitor inlet (as shown in [Figure 87: Connect Calibration Gas](#)) and wait for the gas reading to settle.

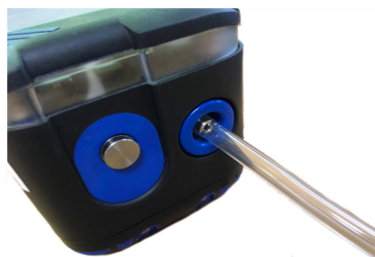

Figure 87: Connect Calibration Gas

- If the displayed reading does not match the concentration of the calibration gas, correct by pressing the appropriate soft-key.

Press **+** button to increase the reading

Press **-** button to decrease reading

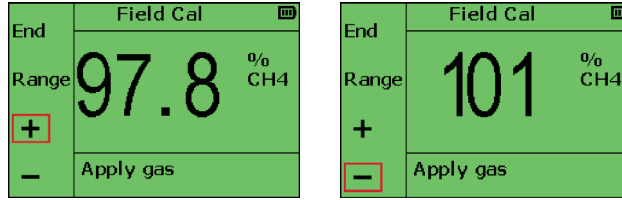

Figure 88: Field Calibration - Adjustment

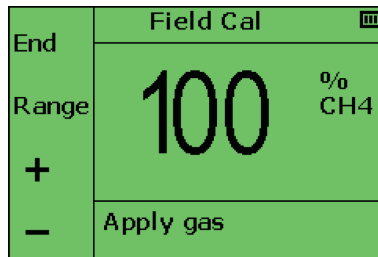

Figure 89: Field Calibration - Completed Adjustment

- When the gas reading corresponds to the concentration of calibration gas, disconnect the tubing from the monitor.
- Press the **Range** button to change range and calibrate another gas. Repeat steps 4 to 9 for each range.
- Press the **End** button after all required ranges have been calibrated.
- Save screen will appear (as shown in [Figure 90: Field Calibration Save](#)).

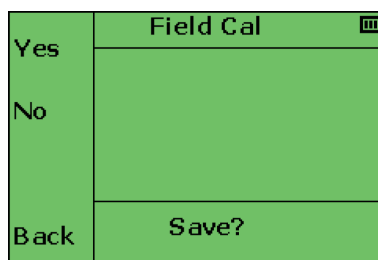

Figure 90: Field Calibration Save

Press **Yes** button to save the calibration.

Press **No** button to exit the Field Calibration mode without saving the calibration.

Press **Back** button to return to the Field Calibration mode.

8.3. Manual Calibration

Teledyne GMI's FlexiCal Plus software facilitates manual calibration by:

- Setting up of the calibration test.
- Step by step instruction during calibration.
- Storage of test results files.

Manual calibration requires the user to control the delivery of gas during calibration.

For details on manual calibrating of the monitor using the FlexiCal Plus software, please refer to the [FlexiCal Plus User Handbook](#) - part no. 99551.

8.4. Automatic Calibration

For details on automatic calibration of the monitor using the GDUnet station, please refer to the following documents:

- [GDUnet User Handbook](#) - part no. 14765
- [FlexiCal Plus User Handbook](#) - part no. 99551



Figure 91: GDUnet Station

9. Accessories

9.1. Consumables

Part No.	Description
67163	Instrument Dust Filter - Box of 30
49218	Instrument Hydrophobic Filter Assembly
12358	Probe Hydrophobic Filter
10077	Probe Cotton Filter - Box of 10
10278	Alkaline Battery (x1)

9.2. Accessories

Part No.	Description
12712	Sample Line (Tygon) - per metre
13393	Plastic Probe - 80cm (Solid End)
42700	Extended Survey Probe Assembly (including Bellows Probe)
42800	Extended Survey Probe Assembly (including Swan Neck Probe)
42200	Semiconductor Flexi Probe Assembly (GS700 must be fitted with a semiconductor probe connector).
12481	Probe Handle Assembly
49221	Rechargeable Battery Pack
49460	Charger Cradle (including Universal PSU)
49300	Car Charging Lead for the Carger Cradle
12451	Hex Driver
14750X	GDUnet station (6mm fittings)
14750XQ	GDUnet station (1/4in. fittings)
99118	On-Demand Flow Regulator

9.3. Software

Part No.	Description
48151	FlexiCal Plus Package (CD + IR Adaptor)
48365	Spare IR Adaptor



Note: For a comprehensive list of spare parts, probes, accessories and calibration gases, contact your local distributor or alternatively, Teledyne GMI.

10. Monitor Specifications

Gas	Range	Resolution	Sensor Type
Flammable	0-10,000ppm	1 ppm	Semiconductor
	0-10,000ppm	25ppm	Infrared
Flammable	0 to 9.9% LEL	0.1%	Infrared
	10 to 100% LEL	1%	
Flammable	0 to 5% Volume	0.1%	Infrared
	5 to 100% Volume	1%	
Oxygen (O ₂)	0 to 20.9%	0.1%	Electrochemical
	21 to 25%	1%	
Carbon Monoxide (CO)	0 to 1000ppm	1 ppm	Electrochemical
Hydrogen Sulfide (H ₂ S)	0 to 100ppm	1 ppm	Electrochemical

Other Specifications	
Dimensions (excluding probe):	190mm x 98mm x 107mm (7.4" x 3.8" x 4.2")
Weight:	Alkaline - 1.4 kg (3.1lbs.) / Rechargeable -1.3 kg (2.7 lbs.)
Temperature Limits:	-20°C to 50°C (-4°F to 122°F)
Humidity Limits:	0 – 90% R.H. non-condensing
Protection Rating:	Polycarbonate / ABS case with TPE over-moulding protected to IP55
Sampling System:	Integral pump with flow fail sensor. Sample path is protected by a hydrophobic and cotton filter. Flow rate: ~ 0.5 l/min with no restriction. Response times increase ~2 second per metre of tubing used. Maximum tubing length 30 metres.
Power Source:	Alkaline Batteries: 3 x size 'D' (LR20), or Rechargeable Battery Pack. See Section 1.2.3: Batteries for list of approved alkaline batteries.
Battery Life:	Alkaline: 15 hours Rechargeable: 20 hours
Alarms:	360° highly visible flashing LED Top panel highly visible flashing LED Sounder ~ 85 db at 0.3 m
Display:	Monochrome LCD (240 x 160 pixels) with automatic bi-colour backlight

Other Specifications

Datalogging:

500 session logs, each log can include:

- Date & time
- Modes of operation
- Gas readings
- Activated alarms
- Calibration & Bump data
- Barhole logs
- GPS location data

Oldest logs will be overwritten when full.

Instrument performance complies to the relevant sections of the following standards:

- Flammable - BS EN / IEC 60079-29-1
- Flammable - CSA 22.2 No. 152 and ANSI/ISA-12.13.01
- Toxic - BS EN 45544
- Oxygen - BS EN 50104
- China CPA performance standard



Note: All values are typical at normal temperature and pressure. Humidity is between 0% and 90% (non-condensing). User must also ensure that pressure changes at the inlet and exhaust are minimised as they may cause transient changes in reading.

11. Technical Support

This product is designed to provide you with reliable, trouble-free service. Contact your regional technical support if you have technical questions, need support, or if you need to return a product. Details can be found at:

www.teledynegasandflamedetection.com



Note: When returning a product, contact Technical Support to obtain a Return Material Authorization (RMA) number prior to shipping.

Appendix A: Pipeline Gas Test (pre firmware v1.30)

The pipeline gas test is used to discriminate between pipeline gas (natural gas) and non pipeline gas (e.g. landfill or swamp gas).



Note: The pipeline gas test, when configured, can run in the background of ALL modes of operation, except for CSM.

When sampling, the GS700 automatically discriminates and displays the results on the main screen (as shown in [Figure A1: PGT Sampling - Methane](#) and [Figure A2: PGT Sampling - Other Hydrocarbons](#)).

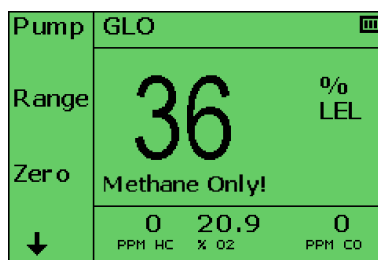

Figure A1: PGT Sampling - Methane

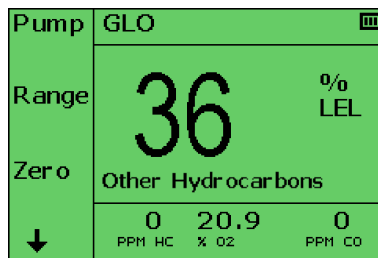

Figure A2: PGT Sampling - Other Hydrocarbons



Note: GS700 will indicate if the gas sample is Methane or other hydrocarbons, providing:

- The measured sample is >1.5% Volume Gas
- The sample source contains a minimum of 2% Ethane

Page intentionally left blank.



TELEDYNE
GAS MEASUREMENT INSTRUMENTS
Everywhereyoulook™



AMERICAS
14880 Skinner Road
Cypress,
TX 77249, USA
Tel: +1-713-559-9200

EMEA
Inchinnan Business Park
Renfrew, PA4, 9RG
Scotland, UK
Tel.: +44 (0) 141 812 3211

ASIA PACIFIC
750C Chai Chee Road
#03-08 Viva Business Park
Singapore 469003
Tel.: +65 84282741



www.teledynegasandflamedetection.com