

CSBSP-01

CLAMP AND SHIM BLOCK W/ SLIDE PLATE ASSEMBLY

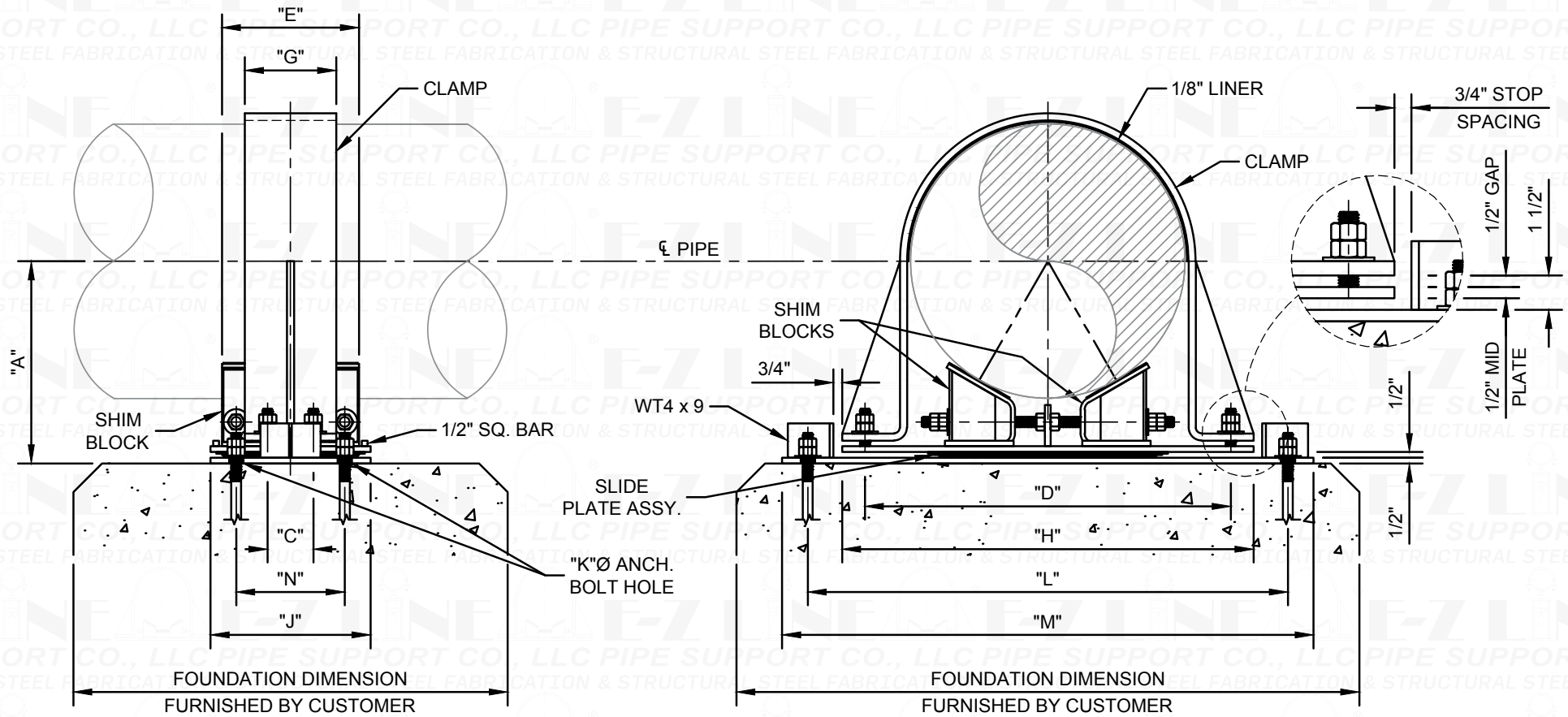

ELEVATION AT PIPE SUPPORT

SECTION THRU PIPE AT SUPPORT