



Aperflux 101

-
-
-

Pressure
Regulators



Aperflux 101

> Pressure regulators

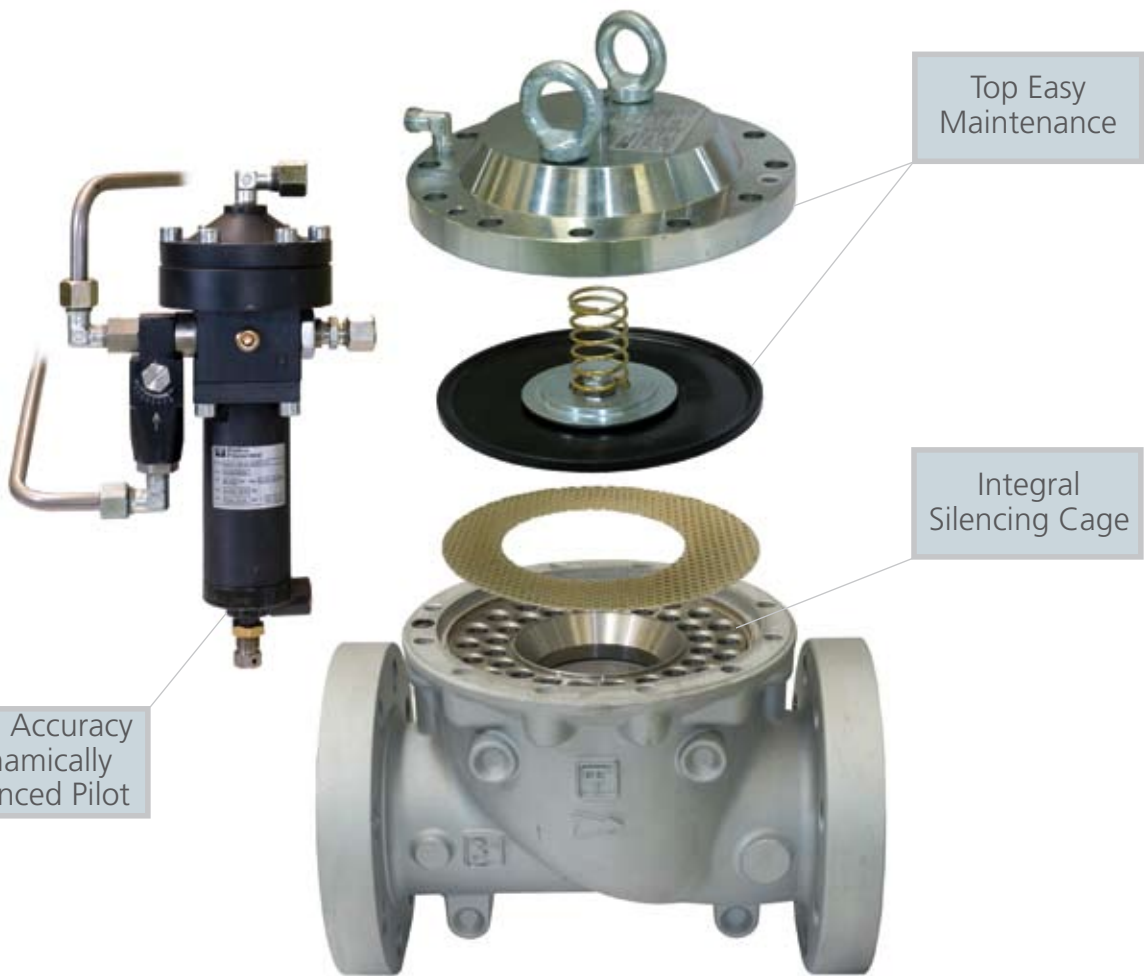

Top Easy Maintenance

Integral Silencing Cage

High Accuracy Dynamically Balanced Pilot

Installation On Any Position

Introduction

Aperflux 101 is a boot style pilot-controlled pressure regulator for medium and high pressure applications.

Aperflux 101 is normally a failed open regulator and specifically will open under the following circumstances:

- breakage of main diaphragm;
- lack of feeding to the pilot circuit.

These regulators are suitable for use with previously filtered, non-corrosive gases.

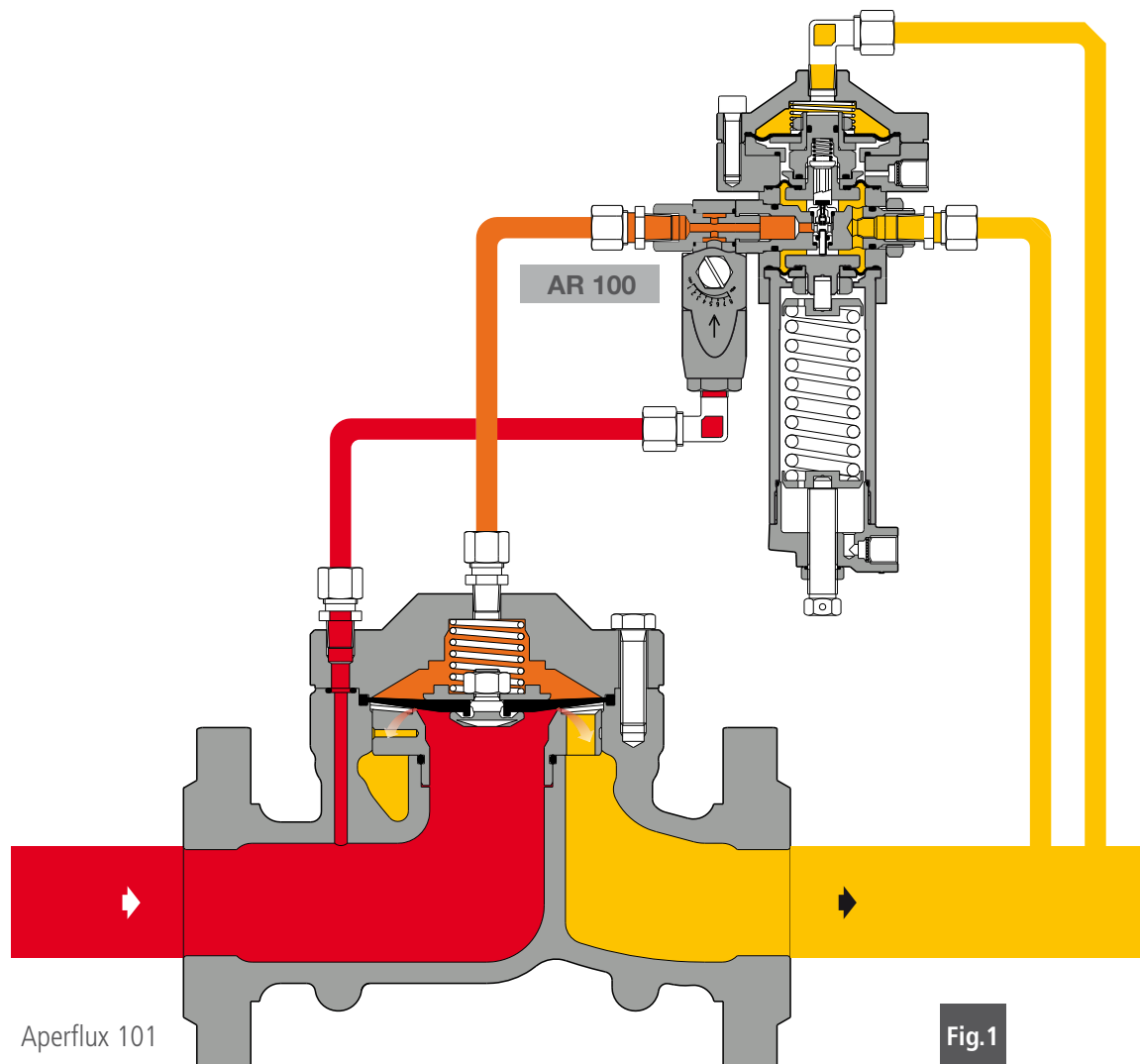

Designed
With Your
Needs In Mind

- Compact Design
- Easy Maintenance
- Top Entry
- Low Noise

- High Turn Down Ratio
- High Accuracy
- Low Operation cost



Main Features

- Design pressure: up to 85 bar (1232,8 Psi)
- Operating temperature: -10 °C to +60 °C (14 to + 140 °F)
- Ambient temperature: -20 °C to +60°C (-4 to + 140 °F)
- Range of inlet pressure bpu: 3 to 85 bar (43,5 to 1232,8 Psi)
- Range of outlet pressure Wd: 2 to 74 bar (29 to 1073,3 Psig) depending on installed pilot
- Minimum working differential pressure: 1 bar (14,5 Psi) - Recommended > 2 bar (29 Psig)
- Accuracy class AC: up to 1 depending on the outlet pressure
- Closing pressure class SG: 10 depending on the outlet pressure
- Available size DN: 2" - 3" - 4"
- Flanging: class 300-600 RF or RTJ according to ANSI B16.5

Materials

Body	Cast steel ASTM A352 LCC for rating 300 and 600
Head covers	Rolled or forged carbon steel A350 LF2
Diaphragm	Vulcanized rubber
Valve seat	Stainless steel
Seals	Nitril rubber
Compression fittings	According to DIN 2353 in zinc-plated carbon steel

The characteristics listed above are referred to standard products. Special characteristics and materials for specific applications may be supplied upon request.



Aperflux 101

Choosing the pressure regulator

Sizing of regulators is usually made on the basis of C_g valve and K_G sizing coefficients (table 1). Flow rates at fully open position and various operating conditions are related by the following formulae where:

Q = flow rate in Stm^3/h
 P_u = inlet pressure in bar (abs)
 P_d = outlet pressure in bar (abs).

A > When the C_g and K_G values of the regulator are known, as well as P_u and P_d , the flow rate can be calculated as follows:

A-1 in sub critical conditions: ($P_u < 2 \times P_d$)

$$Q = K_G \times \sqrt{P_d \times (P_u - P_d)} \quad Q = 0.526 \times C_g \times P_u \times \sin \left(K_1 \times \sqrt{\frac{P_u - P_d}{P_u}} \right)$$

A-2 in critical conditions: ($P_u \geq 2 \times P_d$)

$$Q = \frac{K_G}{2} \times P_u \quad Q = 0.526 \times C_g \times P_u$$

B > Vice versa, when the values of P_u , P_d and Q are known, the C_g or K_G values, and hence the regulator size, may be calculated using:

B-1 in sub-critical conditions: ($P_u < 2 \times P_d$)

$$K_G = \frac{Q}{\sqrt{P_d \times (P_u - P_d)}} \quad C_g = \frac{Q}{0.526 \times P_u \times \sin \left(K_1 \times \sqrt{\frac{P_u - P_d}{P_u}} \right)}$$

B-2 in critical conditions ($P_u \geq 2 \times P_d$)

$$K_G = \frac{2 \times Q}{P_u} \quad C_g = \frac{Q}{0.526 \times P_u}$$

NOTE: The sin val is understood to be DEG.

Table 1: C_g , C_1 , K_G and K_1

coefficient Nominal diameter (mm)	50	80	100
Size (inches)	2"	3"	4"
C_g flow coefficient	1682	4200	7217
K_G flow coefficient	1768	4414	7586
K_1 body shape factor	103	108	105
C_1 body shape factor	33.17	31.64	32.54

Aperflux 101



> Pressure regulators

The formulae are applicable to natural gas having a relative density of 0.61 w.r.t. air and a regulator inlet temperature of 15 °C. For gases having a different relative density d and temperature t_U in °C, the value of the flow rate, calculated as above, must be multiplied by a correction factor F_c , as follows:

$$F_c = \sqrt{\frac{175.8}{S \times (273.16 + t_U)}}$$

Table 2 lists the correction factors F_c for a number of gases at 15 °C.

Table 2: Correction factors F_c

Type of gas	Relative density	F_c Factor
Air	1.0	0.78
Propane	1.53	0.63
Butane	2.0	0.55
Nitrogen	0.97	0.79
Oxygen	1.14	0.73
Carbon dioxide	1.52	0.63

Caution:

in order to get optimal performance, to avoid premature erosion phenomena and limit noise emissions, it is recommended to check that the gas speed at the outlet flange does not exceed the following values:

PD ≤ 5 bar V ≤ 200 m/sec.

PD ≥ 5 bar V ≤ 150 m/sec.

The gas speed at the outlet flange may be calculated by means of the following formula:

$$V = 345.92 \times \frac{Q}{DN^2} \times \frac{1 - 0.002 \times Pd}{1 + Pd}$$

where:

V = gas speed in m/sec

Q = gas flow rate in Stm^3/h

DN = nominal size of regulator in mm

Pd = outlet pressure in barg.

Pilots System

Pilots

Aperflux 101 regulators are equipped with series 300 pilot as listed below:

- 302/. control range Wd: 0.8 to 9,5 bar; (11,6 to 137,7 psig)
- 304/. control range Wd: 7 to 43 bar; (101,5 to 623,5 psig)
- 305/. control range Wd: 20 to 60 bar; (290 to 870,2 psig)
- 307/. control range Wd: 41 to 74 bar; (594,6 to 1073,3 psig)

Pilots may be adjusted manually or remotely as shown in table 3:

Table 3: Pilot adjusting instructions

Pilot type .../A	Manual setting
Pilot type .../D	Electric remote setting control
Pilot type .../CS	Setting increased by pneumatic signal remote point

The pilot system comes complete with an adjustable **AR100** restrictor. The flow rate of the pilot system is controlled by the bleed rate through **AR100** restrictor.

The KG coefficients of the **AR100** adjustable restrictor for its various degrees of opening are shown on Fig. 2.

KG formula used for calculating the flow rate of regulator can be applied for adjustable restrictor **AR100**.

It is necessary to consider that pressure drop through the adjustable **AR100** restrictor should be about 2.9 PSIG (0,2) bar at the minimum opening flow of the regulator and about 14,5 PSIG (1 bar) at the maximum opening flow of regulator main diaphragm.

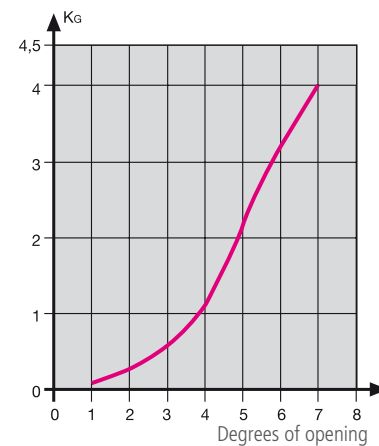

Fig.2

Accessories on request

For Regulator

- Internal connection for pilot bleed
- flow-limiting devices
- limit switches
- stainless steel fittings, single or dual sealing

For Pilot

- supplementary filter **CF 14**
- dehydrating filter **CF 14/D**

Aperflux 101

> Pressure regulators



In-line monitor

The monitor is generally installed upstream of the main regulator. Although the function of the monitor regulator is different, the two regulators are virtually identical from the point of view of their mechanical components. The only difference is that monitor is set at a higher pressure than the main regulator. The Cg and KG coefficients of the regulator plus in-line monitor system are about 20% lower than those of the regulator alone.

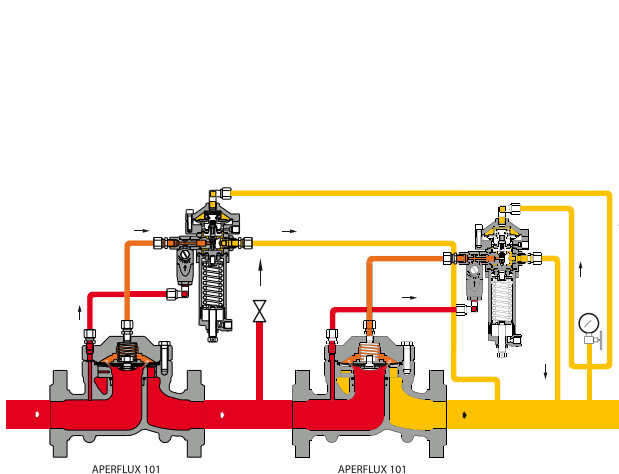

Fig.3

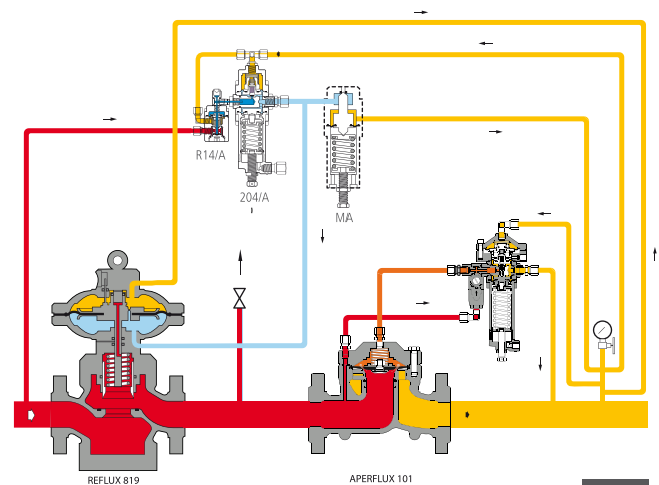

Fig.4

M/A Accelerator

When the monitor is required to take over more rapidly in the event of a main regulator failure, an **M/A** accelerator pilot is installed on the monitor (Fig. 4). Installation of the accelerator is mandatory when monitor is used on safety accessory according to PED directive. Depending on a downstream pressure signal, this device discharges the gas enclosed in the motorisation chamber of the monitor regulator, allowing the monitor to take over faster.

The set point of **M/A** accelerator is usually higher than set point of the monitor by 0.3 to 0.5 bar.

In case of monitor override configuration (two stage cut) the accelerator may be not necessary.

Installation

Whenever **Aperflux 101** pressure regulator is being installed, it is essential to follow a few basic rules in order to ensure the achievement equipment's operational and performance characteristics.

These rules may be summarised as follows:

- filtering: the gas arriving from the main pipeline must be adequately filtered; it is also advisable to make sure that the pipe upstream of the regulator is perfectly clean and void of residual impurities;
- pre-heating: whenever the pressure drop at the regulator is considerable, the gas must be pre-heated enough to avoid the formation of ice during decompression (for reference natural gas the temperature drop is about 0,4 °C to 0,5 °C for every bar of pressure reduction);
- condensate collector: natural gas sometimes contain traces of vapour-state hydrocarbons that can interfere with the functioning of the pilot. It is therefore necessary to install a condensate collector, complete with drainage system, upstream of the pilot circuit;
- Outlet pipe size must also be sized correctly so the velocity is not too high. High velocity will result in improper pressure control.
- impulse take-off: for correct operation, the impulse take-off must be located in the right position. Between the regulator and the downstream take-off there must be a straight length of pipe ≥ 4 times the diameter of the outlet pipe and downstream the take-off, there must be a further length of pipe ≥ 2 times the same diameter.

Possible installation schemes

APERFLUX 101 + APERFLUX 101

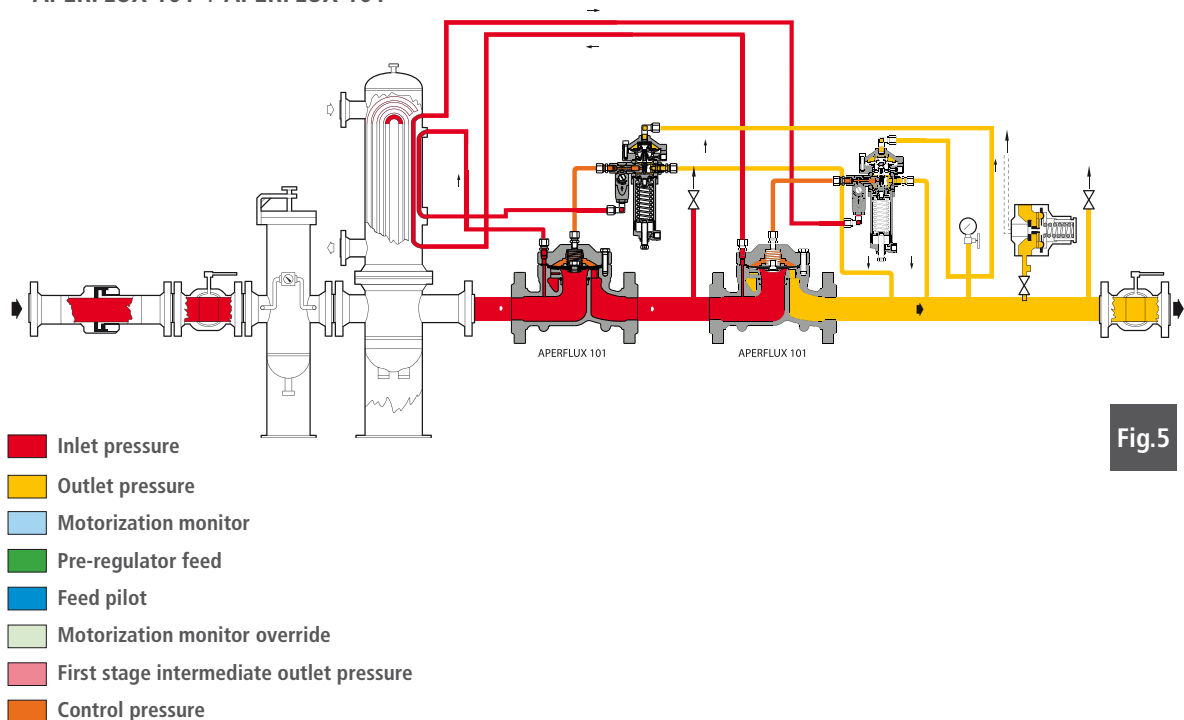

Fig.5

Aperflux 101



> Pressure regulators

REFLUX 819 + SB/82 + APERFLUX 101

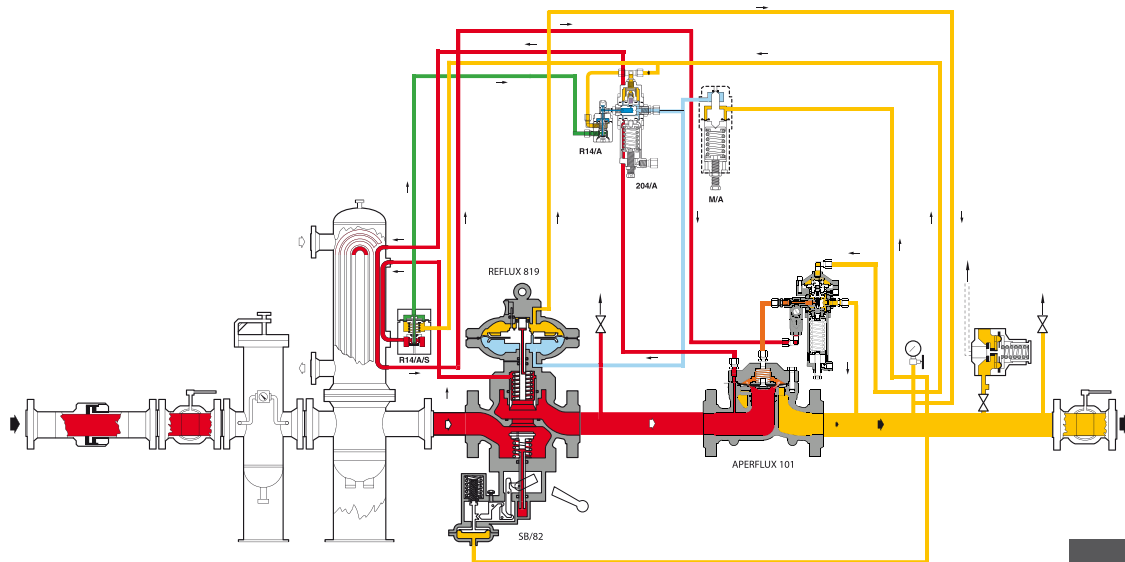

Fig.6

REFLUX 819/MO +SB82 + APERFLUX 101

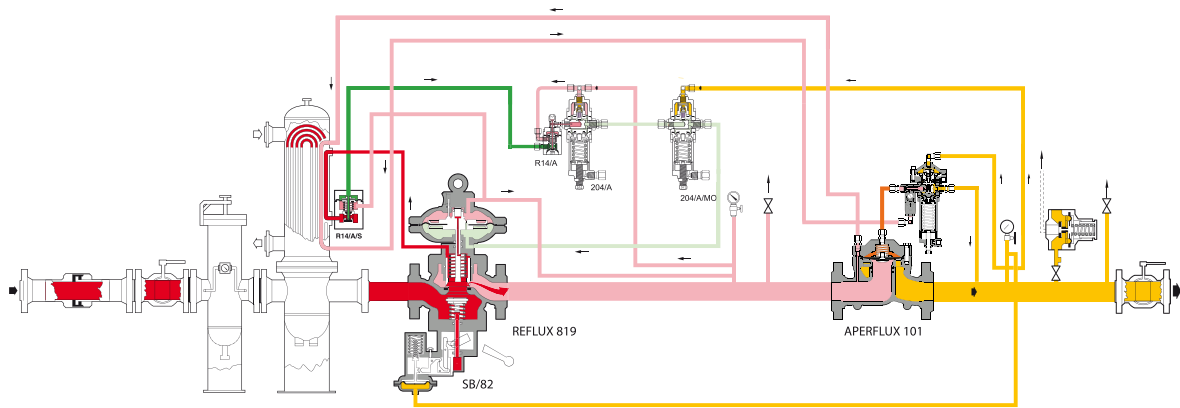
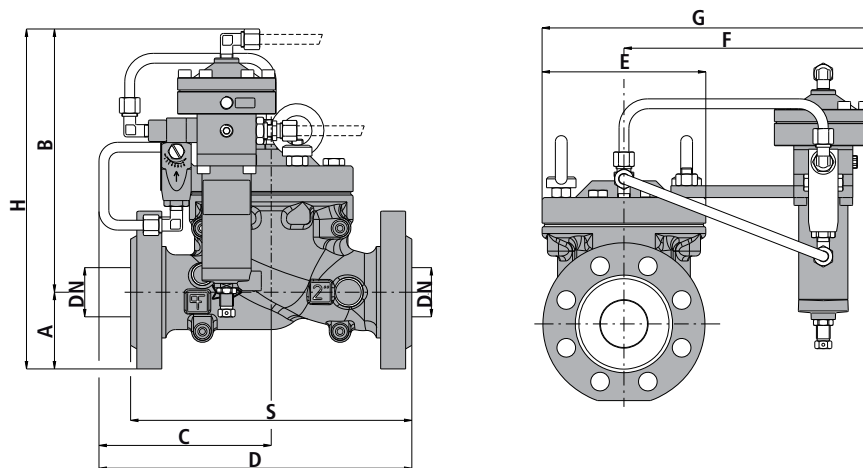

Fig.7

Aperflux 101

Overall dimensions in mm

Size (mm)	50	80	100
Inches	2"	3"	4"
A	78	100	126
B	270	290	349
C	175	185	198
D (ANSI 300)	310	342	382
D (ANSI 600)	320	352	395
E	167	235	290
F	255	290	312
G	340	408	457
H	348	390	451
S (ANSI 300)	267	317	368
S (ANSI 600)	286	336	394

Weights in Kgf (with P302)

ANSI 300	24,5	47	92
ANSI 600	26,5	51	102

Face to face dimensions S according to IEC 534-3 and EN 334



Pietro Fiorentini S.p.A.
via E.Fermi 8/10
I-36057 Arcugnano (VI)
Italy

Tel. +39 0444 968.511
Fax. +39 0444 960.468

www.fiorentini.com

via Rosellini 1
I-20124 Milano
Italy

Tel. +39 02 696.14.21
Fax. +39 02 688.04.57

