

# FLOWSIC550

Gas flow meter

**SICK**  
Sensor Intelligence.



---

**Described product**

FLWSIC550

**Manufacturer**

SICK Engineering GmbH

Bergener Ring 27 · D-01485 Ottendorf-Okrilla · Germany

Phone: +49 35205 52410

Fax: +49 35205 52450

E-mail: info.pa@sick.de

**Legal information**

This work is protected by copyright. Any rights derived from the copyright shall be reserved for SICK Engineering GmbH.

Reproduction of this document or parts of this document is only permissible within the limits of the legal determination of Copyright Law. Any modification, shortening or translation of this document is prohibited without the express written permission of SICK Engineering GmbH.

The trademarks stated in this document are the property of their respective owner.

© SICK Engineering GmbH. All rights reserved.

**Original document**

This document is an original document of SICK Engineering GmbH

## Contents

<b>1</b>	<b>About this document.....</b>	<b>6</b>
1.1	Function of this document.....	6
1.2	Scope of application .....	6
1.3	Further information.....	6
1.4	Symbols and document conventions .....	6
1.4.1	Warning symbols.....	6
1.4.2	Warning levels and signal words.....	7
1.4.3	Information symbols .....	7
<b>2</b>	<b>For your safety.....</b>	<b>8</b>
2.1	Basic safety information .....	8
2.2	Warning information on device .....	8
2.3	Intended use .....	9
2.4	Operation in potentially explosive atmospheres .....	9
2.5	Restrictions of use .....	9
2.6	Responsibility of user.....	9
2.7	Information on cybersecurity threats .....	10
<b>3</b>	<b>Product description .....</b>	<b>11</b>
3.1	Product identification.....	11
3.2	Measuring principle .....	11
3.2.1	Gas flow meter.....	11
3.2.2	Volume conversion (optional).....	12
3.3	System components .....	13
3.3.1	Meter body .....	13
3.3.2	Ultrasonic transducers .....	13
3.3.3	Signal processing unit (SPU) .....	14
3.4	Interfaces .....	14
3.4.1	Digital outputs.....	14
3.4.2	Serial data interface .....	14
3.4.3	Service interface .....	14
3.5	FLOWgate™ operating software .....	15
3.5.1	Overview .....	15
3.5.2	System requirements .....	15
3.6	Volume conversion (option).....	16
<b>4</b>	<b>Transport and storage.....</b>	<b>18</b>
4.1	Transport .....	18
4.2	Storage .....	18
<b>5</b>	<b>Project planning.....</b>	<b>19</b>
5.1	Preparing the measuring point.....	19
5.2	Choosing flanges, gaskets and other components .....	19

- 6 Mounting..... 20**
  - 6.1 Safety ..... 20
  - 6.2 Scope of Delivery ..... 20
  - 6.3 Fitting in the pipeline..... 21
  - 6.4 Signal processing unit alignment..... 22
  
- 7 Electrical installation..... 23**
  - 7.1 Safety ..... 23
  - 7.2 Opening and closing the electronics cover..... 24
  - 7.3 Electrical connections ..... 25
    - 7.3.1 Cable specifications ..... 28
  - 7.4 Battery operation ..... 29
  - 7.5 Installing the pressure and temperature sensor..... 30
  
- 8 Commissioning ..... 31**
  - 8.1 Important information ..... 31
  - 8.2 Commissioning with the FLOWgate™ operating software ..... 31
    - 8.2.1 Auxiliary means and accessories required..... 31
  - 8.3 Connecting to the device..... 31
    - 8.3.1 Field setup wizard ..... 33
      - 8.3.1.1 Identification ..... 33
      - 8.3.1.2 System/user ..... 33
      - 8.3.1.3 Warnings ..... 34
      - 8.3.1.4 Archive/Logbooks..... 34
      - 8.3.1.5 I/O Configuration ..... 34
      - 8.3.1.6 EVC (Electronic Volume Converter)..... 34
      - 8.3.1.7 Finalize ..... 35
    - 8.3.2 Function check after commissioning ..... 35
  
- 9 Operation ..... 36**
  - 9.1 Operating using the display..... 36
  - 9.2 Display in the symbol bar ..... 37
  - 9.3 Battery fill level display..... 37
  
- 10 Maintenance..... 38**
  - 10.1 Maintenance work ..... 38
  - 10.2 Cleaning ..... 38
  - 10.3 Information on handling lithium batteries..... 38
    - 10.3.1 Information on storage and transport ..... 39
    - 10.3.2 Disposal information ..... 39
  
- 11 Troubleshooting..... 40**
  - 11.1 Contacting customer service..... 40
  
- 12 Decommissioning..... 41**
  - 12.1 Safety information on decommissioning..... 41

---

12.2	Return delivery .....	41
12.2.1	Contact .....	41
12.2.2	Clearance certificate .....	41
12.2.3	Packaging.....	41
<b>13</b>	<b>Technical data .....</b>	<b>42</b>
13.1	Dimension drawings.....	42
13.2	Technical data.....	43
13.3	Application ranges .....	45
<b>14</b>	<b>Annex.....</b>	<b>46</b>
14.1	Type plates .....	46
14.2	Control drawing.....	47

## 1 About this document

### 1.1 Function of this document

These Operating Instructions describe:

- Device components
- Installation
- Operation
- Maintenance work required for reliable operation
- Decommissioning

They contain the main safety information for safe operation of the FLOWSIC550.

### 1.2 Scope of application

These Operating Instructions are only applicable for the measuring device described in the product identification.









### 1.3 Further information

Observe the supplied documents.

### 1.4 Symbols and document conventions

#### 1.4.1 Warning symbols

Table 1: Warning symbols

Symbol	Significance
	Hazard (general)
	Hazard by electrical voltage
	Hazard by explosive substances/mixtures
	Hazard by oxidizing substances
	Hazard by toxic substances
	Hazard by unhealthy substances
	Hazard by high temperature or hot surfaces
	Hazard for environment/nature/organisms

### 1.4.2 Warning levels and signal words

**DANGER:**

Risk or hazardous situation which *will* result in severe personal injury or death.

**WARNING:**

Risk or hazardous situation which *could* result in severe personal injury or death.

**CAUTION:**

Hazard or unsafe practice which *could* result in less severe or minor injuries.



**NOTICE:**

Hazard which *could* result in property damage.

**Note:**

Hints

### 1.4.3 Information symbols

Symbol	Significance
	Important technical information for this product
	Important information for electrical or electronic functions

## 2 For your safety

### 2.1 Basic safety information

- ▶ Read and observe these Operating Instructions.
- ▶ Observe all safety instructions.
- ▶ If anything is not clear: Please contact the manufacturer.

#### Retention of documents

- ▶ These Operating Instructions must be kept available for reference.
- ▶ These Operating Instructions must be passed on to new owners.

#### Correct use

- ▶ Only use the measuring device as described in these Operating Instructions. The manufacturer bears no responsibility for any other use.
- ▶ Do not carry out any work or repairs on the measuring device not described in this manual.
- ▶ Do not remove, add or change any components in or on the measuring device unless such changes are officially allowed and specified by the manufacturer.  
Otherwise
  - The measuring device can become dangerous.
  - The measuring device can lose function.
  - The approval for use in lines pressurized above 50 kPa (0.5 bar) is no longer valid.

#### Special local conditions

- ▶ Follow all local laws, regulations and company-internal operating directives applicable at the installation location.

### 2.2 Warning information on device



#### **WARNING: Danger identification on device**

The following symbol draws attention to important dangers directly on the device:



- ▶ Consult the Operating Instructions in all cases where the symbol is attached to the device or shown on the display.
-



## 2.3 Intended use

The FLOWSIC550 serves for measuring the gas volume, volume flow rate and gas velocity of natural gas in pipelines.

The FLOWSIC550 with optional volume conversion serves for measuring the gas volume and converting the gas volume measured to base conditions as well as registering data on totalizer levels, maximums and other data.

## 2.4 Operation in potentially explosive atmospheres

The FLOWSIC550 is designed for use in potentially explosive atmospheres according to the respective device version, see [“Technical data”, page 42](#).



### **WARNING: Risk of ignition through impacts or friction**

The ultrasonic transducers are manufactured from titanium. In rare cases, ignition sources due to impact or friction sparks could occur.

The user shall ensure that the ultrasonic transducers are suitably protected against danger from impact or friction

## 2.5 Restrictions of use

- ▶ Refer to the type plate for the configuration of your measuring device.
- ▶ Check the measuring device is suitably equipped for your application (e.g. gas conditions)
- ▶ The measuring device is suitable for use in pressurized lines within the combination of maximum allowable Temperature and pressure specified on the type plate.
- ▶ For use at temperatures below the maximum allowable temperature, the maximum allowable pressure can be increased within the values as following:
  - Class 300 (ASME B16.5): 51 bar(g) for -40 °C ... 38 °C  
740 psi(g) for -40 °F...100 °F
  - Class 600 (ASME B16.5): 102 bar(g) for -40 °C ... 38 °C  
1480psi(g) for -40 °F...100 °F
- ▶ Pressure ratings for temperatures between 38 °C (100 °F) and maximum allowable temperature can be determined through interpolation.
- ▶ It is the user's responsibility to ensure these maximum allowable values are not exceeded during operation.



### **NOTICE:**

The device has been tested for electromagnetic compatibility in industrial environments according to IEC 61326-1. Additional measures may be required for use in electromagnetic environments with higher interference levels.

## 2.6 Responsibility of user

The measuring device may only be operated by skilled persons who, knowledgeable of relevant regulations, and able to assess potential hazards related to its operation.

Skilled persons are persons according to DIN VDE 0105, DIN VDE 1000-10 or IEC 60050-826 or directly comparable standards.



### **NOTICE:**

Skilled persons must have exact knowledge on hazards arising from operation, e.g. through hot, toxic, explosive gases or gases under pressure, gas-liquid mixtures or other media as well as adequate knowledge of the measuring system gained through training.

### 2.7 Information on cybersecurity threats

Protection against cybersecurity threats requires a comprehensive cybersecurity concept that must be continuously reviewed and maintained. A suitable concept consists of organizational, technical, procedural, electronic and physical levels of defense and takes into account appropriate measures for the different types of risk. The measures implemented in this product can only support protection against cybersecurity threats if the product is used as part of such a concept.

Visit [www.sick.com/psirt](http://www.sick.com/psirt) for more information, such as:

- General information on cybersecurity
- Contact option for reporting vulnerabilities
- Information on known vulnerabilities (Security Advisories)

### 3 Product description

#### 3.1 Product identification

Product name:	FLWSIC550
Manufacturer:	SICK Engineering GmbH Bergener Ring 27 D-01485 Ottendorf-Okrilla Germany

The type plates are located on the the signal processing unit and the meter body.

► For a detailed view of the type plates, see “Type plates”, page 46.

#### 3.2 Measuring principle

##### 3.2.1 Gas flow meter

The FLOWSIC550 works according to the principle of ultrasonic transit time difference measurement.

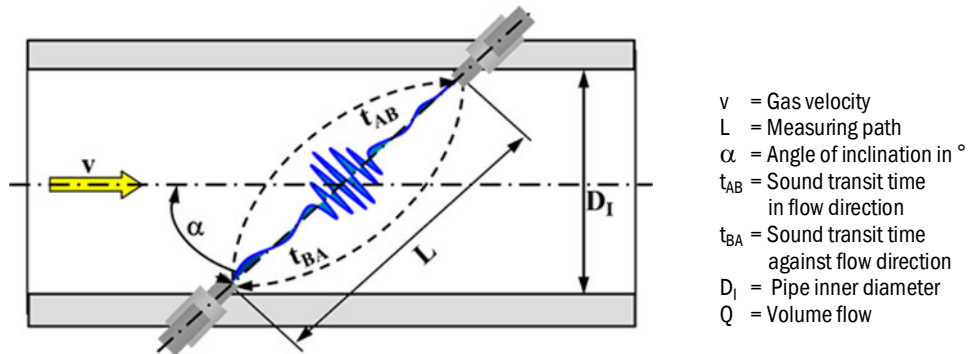

Fig. 1: Functional principle

Measured signal transit times  $t_{AB}$  and  $t_{BA}$  are defined by the current sound and gas velocity.

Gas velocity  $v$  is determined from the difference between the signal transit times. Therefore changes in the sound velocity caused by pressure or temperature fluctuations do not affect the calculated gas velocity with this measurement method.

The FLOWSIC550 calculates the volume flow rate internally from the gas velocity and the diameter of the measuring section of the gas flow meter.

$$Q = \frac{\pi}{4} D_I^2 \cdot \frac{L}{2 \cos \alpha} \cdot \frac{t_{BA} - t_{AB}}{t_{AB} \cdot t_{BA}}$$

#### 3.2.2 Volume conversion (optional)

The integrated volume conversion converts the measured gas volume from measurement conditions to base conditions.

Calculation according to EN 12405:

$$V_b = C \cdot V_m$$

$$C = \frac{p}{p_b} \cdot \frac{T_b}{T} \cdot \frac{Z_b}{Z}$$

$V_b$  = Volume at base conditions  
 $C$  = Conversion factor  
 $V_m$  = Volume at measurement conditions

$p$  = Gas pressure at measurement conditions  
 $p_b$  = Pressure at base conditions  
 $T$  = Gas temperature at measurement conditions  
 $T_b$  = Temperature at base conditions  
 $Z_b$  = Compression factor at base conditions  
 $Z$  = Compression factor at measurement conditions

The measurement conditions are either determined with pressure and temperature sensors or entered as fixed value.



The following short forms are used in this document for better readability:

- Volume at base conditions = base volume
- Volume at flowing conditions = measurement volume

### 3.3 System components

The FLOWSIC550 measuring system comprises:

- the meter body with a straight pipe section with ultrasonic measuring paths and an integrated flow conditioner,
- the signal processing unit (SPU) measurement and interface electronic,
- optional pressure and temperature sensors for the volume conversion device option.



- 1 Signal processing unit (SPU)
- 2 Meter body
- 3 Cover for ultrasonic transducers

Fig. 1: FLOWSIC550 components

#### 3.3.1 Meter body

The meter body is available in various flange standards and fitting lengths to connect the gas flow meter to the system pipeline. Depending on the version, the adapter is designed for assembly on line flanges CL300 or CL600 in accordance with ASME B16.5.

An internal flow conditioner rectifies the gas flow in the gas flow meter so that flow profile disturbances caused by pipe bends in the inlet or outlet sections or components projecting into the pipe (e.g. a thermowell) are negligible on measuring results.

#### 3.3.2 Ultrasonic transducers

Ultrasonic transducers optimally tuned to system requirements are fitted on the measuring device. The high quality of the transducer design provides the basis for accurate and highly stable transit time measurement of the ultrasonic signals.

#### 3.3.3 Signal processing unit (SPU)

The signal processing unit (SPU) contains all the electrical and electronic components for controlling the ultrasonic transducers. It generates transmission signals and analyzes the received signals to calculate the measuring values. The SPU also contains several interfaces for communication with a PC or standardized process control system.

The SPU is fitted with:

- Control unit
- Electrical interfaces
- Batteries
- Display

#### 3.4 Interfaces

The FLOWSIC550 supports following interfaces:

DO_0	HF (testing)	deactivated
DO_1	LF	activated
DO_2	Status	activated
RS485_1	Data	activated
RS485_2	Data	activated

##### 3.4.1 Digital outputs

###### Pulse and status outputs

FLAWSIC550 has 3 digital outputs. The digital outputs are electrically isolated. When used as pulse output during battery operation, maximum 10 Hz can be output on digital switching outputs DO\_1 and DO\_2. The conversion of the measured value into the pulses to be output is done via the meter factor. Refer to the device documentation for the preset meter factor.

When used as status output, status information “Validity of measurement” or the result of the self- diagnosis can be represented. The digital outputs are updated synchronously once per second.

##### 3.4.2 Serial data interface

FLAWSIC550 has 2 RS485 interfaces designed as externally powered RS485 and requires an external intrinsically safe power supply for operation.

##### 3.4.3 Service interface

A wired adapter M12/USB (accessory) can be used to connect to the meter with the FLOWgate™ operating software. The interface can be used to read out data and parameter settings, to configure the FLOWSIC550.

### 3.5 FLOWgate™ operating software

#### 3.5.1 Overview

The FLOWgate™ operating software allows user-friendly access to operating actions and measured values of the device.

##### Software functions

- Measured values overview
- Diagnosis data
- Logbook and archive management
- Commissioning
- Parameter modification
- Session browser

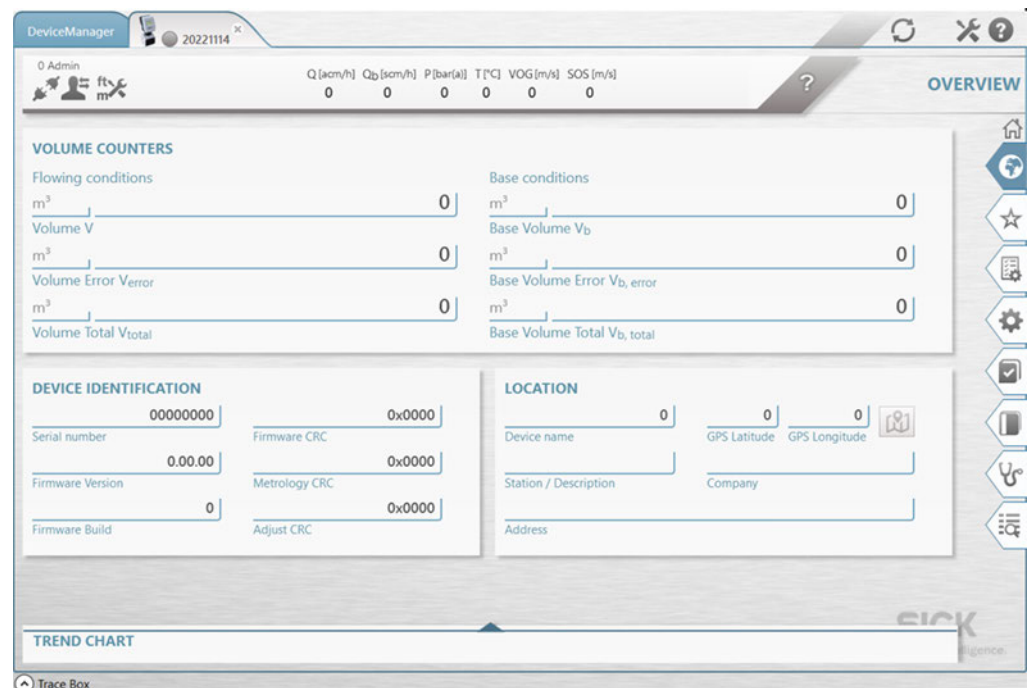

Fig. 2: FLOWgate™ operating software (example overview page)

#### 3.5.2 System requirements

- Microsoft Windows 7/8/10
- Min. 1 GHz CPU
- Min. 512 MB RAM
- About 100 MB free disk capacity (without .NET framework)
- USB or serial interface
- Recommended minimum screen resolution: 1024 x 768 pixels, optimum screen resolution 1368 x 768 pixels
- Microsoft .NET framework 4.6

3.6 Volume conversion (option)

The FLOWSIC550 gas flow meter with volume conversion captures the gas volume under measurement conditions and converts it to a volume under base conditions.

Gas volume conversion runs as PTZ volume conversion. Measurement conditions are recorded with the pressure and temperature sensors or entered as fixed values.

By default, measured values recording and subsequent calculation of the conversion factor are performed every 30 seconds. The update interval can be adjusted.

Depending on the configuration, the compressibility factor (K-factor) is determined with one of the following calculation methods or can be entered as a fixed value.

- Fixed value
- SGERG88
- AGA 8 Gross method 1
- AGA 8 Gross method 2
- AGA NX-19
- AGA NX-19 mod.
- AGA NX-19 mod. GOST
- GERG91 mod.

FLOWSIC550 checks the permissible entry limits of the parameters for the selected calculation method. If one of the entry values is outside the limit values, the FLOWSIC550 switches to malfunction state and uses the fixed value of the compressibility factor for calculation of the basis volume.

A relative pressure sensor EDT23 or the functionally compatible successor model EDT96 and a temperature sensor EDT34 or the functionally compatible successor model EDT87 measure current measurement conditions and transfer the sensor type, measured value as well as the sensor status via a digital interface.

The FLOWSIC550 reads the valid measuring range automatically and, periodically, the current status and measured value.

A sensor is only activated for measurement when the configured serial number matches the serial number transferred for the sensor.

If no sensor is detected or a sensor is not functioning correctly, the FLOWSIC550 automatically uses the stored default value (= fixed value) of the state variable.

In this case, the FLOWSIC550 switches to malfunction state and, using the default value, stores the volume under base conditions calculated for pressure or temperature in the error volume counter.

If not specified otherwise, the FLOWSIC550 is supplied with the following standard settings:

Unit system	SI	Imperial
T unit	°C	° F
P unit	bar	psi
Symbols according to	EN 12405	API
Calculation method	SGERG88	AGA 8 Gross method 1
Reference conditions for density and heating value	(T1/T2/p2) 25 °C/0 °C/ 1.01325 bar (a)	(T1/T2/p2) 60 °F/60 °F/ 14.7300 psi (a)
Basic pressure	1.01325 bar (a)	14.7300 psi (a)
Basic temperature	0 °C	60 °F



The FLOWSIC550 with volume conversion and external sensors is used at measuring ports where a test/calibration of the pressure or temperature sensor in the system may be required.

It is recommended to install a three-way test valve that separates the pressure sensor from the measurement pressure and provides a test connection to test the pressure sensor.

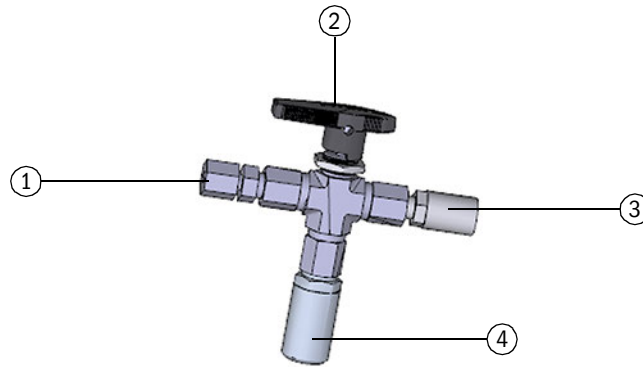

- 1 Pipe screw fitting 1/4" NPT on pipe D06  
or pipe screw fitting 1/4" NPT on pipe 1/4"
- 2 Hand lever
- 3 Test connection (Minimess coupling)
- 4 Pressure sensor, connection thread G 1/4"

*Fig. 2: Three-way test valve with p-sensor and Minimess coupling*

### 4 Transport and storage

#### 4.1 Transport

During all transport and storage work, ensure:

- ▶ The measuring device is always well secured.
- ▶ Measures to prevent mechanical damage have been taken.
- ▶ Ambient conditions are within specified limits, [see “Technical data”, page 42](#).



**WARNING: Hazard due to heavy loads**

When transporting the measuring device, there is a risk of crushing and impact due to the high weight.

- ▶ The measuring device may only be transported by competent persons.
  - ▶ Only use lifting gear and equipment (e.g. lifting straps) suitable for the weight to be lifted.
  - ▶ The lifting lugs are designed for transporting the meter only. Do not lift or transport the measuring device with additional loads using these lugs.
  - ▶ Never attach lifting gear to the signal processing unit and avoid contact between these parts and the lifting gear.
- 

#### 4.2 Storage

- ▶ Ensure that storage conditions are within specified limits, [see “Technical data”, page 42](#).

## 5 Project planning

### 5.1 Preparing the measuring point

- ▶ Select a suitable installation location.
- ▶ Ensure adequate assembly clearances.

### 5.2 Choosing flanges, gaskets and other components



**NOTICE:**

For flange connections only use pipeline flanges, bolts, nuts and gaskets suitable for the maximum operating pressure, maximum operating temperature as well as ambient and operating conditions (external and internal corrosion).

Mounting material will be provided by SICK.

*Table 2: Mounting material*

Part No.	Description
2130423	Mounting set for FLOWSIC550 meter installation 2" with flange type ANSI300/ANSI600
2130428	Mounting set for FLOWSIC550 meter installation 3" with flange type ANSI300/ANSI600
2075562	Adapter for connecting the EDT96 pressure sensor, NPT 1/4" - G 1/4", stainless steel

## 6 Mounting

### 6.1 Safety



**WARNING: Hazards during installation work**

- ▶ Do not carry out any welding work on lines with meters fitted.
- ▶ Comply exactly with mandatory and approved methods.
- ▶ Observe and comply with regulations of the plant operator.
- ▶ Meticulously check completed work. Ensure leak tightness and strength.

Otherwise hazards are possible and safe operation is not ensured.

---



**WARNING: Hazards through the gas in the system**

The following conditions can increase the risk:

- Toxic gas or gas dangerous to health
  - Explosive gas
  - High gas pressure
- ▶ Only carry out installation, maintenance and repair work when the system is non-pressurized.
- 



**WARNING:**

- ▶ Observe applicable valid regulations, general standards and guidelines.
  - ▶ Observe local safety regulations, operating instructions and special regulations.
  - ▶ Observe the safety information in this document.
  - ▶ Persons carrying out installation work must be familiar with the directives and standards applicable for pipeline construction and have the corresponding qualifications.
- 



**NOTICE: VCI corrosion protection**

Remove the protective foam inside the meter body before mounting the device. Otherwise, the device may be damaged and the measuring characteristics could be impaired.

---

### 6.2 Scope of Delivery

The measuring device is delivered preassembled in sturdy packaging.

- ▶ Inspect for transport damage when unpacking the device.
  - ▶ Document any damage found and report this to the manufacturer.
- 



**NOTICE:**

Do not put the measuring device into operation if you notice any damage!

---

**Scope of delivery**

- ▶ Check the scope of delivery for completeness.

The standard scope of delivery comprises:

- Measuring device (meter body and SPU, already fitted)
- Mounting material

## 6.3 Fitting in the pipeline

The measuring device can be installed horizontally or vertically.

### Installation location

Fit the device in an easily accessible and protected position. Carry out all assembly work on-site. The following must be taken into account:

- ▶ Maintain the ambient temperature range in accordance with the technical data under consideration of possible radiant heat (shield when necessary).
- ▶ Protect the device against direct sunlight and atmospheric conditions.
- ▶ Select an installation location free from vibrations when possible and stabilize vibrations when necessary.
- ▶ Provide sufficient clearance for cables and opening the front panel.
- ▶ Select an installation location free of chemical influence

### Installation in pipeline



#### **NOTICE: Observe the gas flow direction**

Install the device so that the flow conditioner is at the gas inlet.

- 1 Select suitable bolts.
- 2 Position the measuring device in the desired location in the pipeline. Lay the pipelines without tension to the device to be installed!
- 3 Insert and align the gaskets. The gaskets must not project into the area through which the gas flows and must be centered on the sealing surface.
- 4 Apply lubricant to the bolts.
- 5 First screw the bolts by hand into the meter body to the stop.
- 6 Check the thread length in the meter body is fully utilized.
- 7 Then install the washers and nuts, and tighten them by hand.
- 8 Check whether the thread length of the nut is fully utilized. If necessary, use a different bolt length.
- 9 Check correct positioning of flange gaskets. The gaskets must not project into the area through which the gas flows and must be centered on the sealing surface.
- 10 Tighten nuts evenly and crosswise in small steps until the specified tightening torque is reached. Make sure the flange sits free of tension.
- 11 Slowly increase the pressure in the pipeline.  
Gradient: Max. 1 MPa/min (10 bar/min)
- 12 Carry out a leak tightness check on the pipeline (in accordance with the pipeline operating company's specifications).

### 6.4 Signal processing unit alignment

- 1 The signal processing unit can be rotated a maximum of  $\pm 180^\circ$ .
- 2 Loosen the four screws on the SPU neck.
- 3 Turn the meter body to the desired position.



**NOTICE:**

Always make sure that the SPU is not rotated more than  $\pm 180^\circ$ . Otherwise, the cables will be damaged.

- 4 Retighten the four screws on the SPU neck that were previously loosened (3 Nm (2.2 lbf ft)).



Fig. 3: Screws on the SPU neck

## 7 Electrical installation

### 7.1 Safety

All assembly work previously described must be completed (as far as applicable) before starting installation work.



#### **WARNING: Electrical hazard**

Incorrect cabling can cause device malfunctions, failure of the measurement system or serious injuries.

- ▶ Observe the relevant safety regulations as well as the safety notices in during all installation work, see [“For your safety”, page 8](#).
- ▶ Take suitable protection measures against possible local hazards or hazards arising from the equipment.
- ▶ All work may only be carried out when the device is disconnected from the power supply.

#### **Requirements for use in potentially explosive atmospheres**

The FLOWSIC550 is designed for use in potentially explosive atmospheres according to the respective device version, see [“Technical data”, page 42](#)

*Special conditions for use:*

- 1 Information on power supply / battery combination limitations, see [see “Electrical connections”, page 25](#).
- 2 The equipment pressure sensor and ultrasonic transducers that are mounted in the meter body contain piezo-electric devices. The equipment installation shall ensure that these devices are suitably protected from impact.
- 3 The ultrasonic transducers that are mounted in the meter body are manufactured from titanium. The equipment installation shall ensure that these devices are suitably protected from impact or friction.
- 4 The adhesive labels that are fitted to the flow meter may generate an ignition-capable level of electrostatic discharge under certain conditions. The user shall ensure that the equipment is not installed in a location where it may be subjected to external conditions which might cause a build-up of electrostatic charges on these non-conducting surfaces. Additionally, cleaning of the equipment should be done only with a damp cloth.
- 5 The flow meter is considered not capable of passing a 500V r.m.s. a.c. dielectric strength test according to Clause 6.3.13 of IEC 60079-11:2011, CAN/CSA-C22.2 No. 60079-11:14, ANSI/UL 60079-11 6th Edition between the intrinsically safe circuits that are associated with the Ext. Power and the Service / Bluetooth M12 Connector connections, and its enclosure. This shall be taken into account in any equipment installation. The circuits associated with external connections RS485-1, RS485-2, DO0, DO1 and DO2 are isolated from the equipment enclosure, and are considered capable of passing a 500V r.m.s. a.c. dielectric strength test according to Clause 6.3.13 of IEC 60079-11:2011, CAN/CSA-C22.2 No. 60079-11:14, ANSI/UL 60079-11 6th Edition.
- 6 The flow meter is considered not capable of passing a 500V r.m.s. a.c. dielectric strength test according to Clause 6.3.13 of IEC 60079-11:2011, CAN/CSA-C22.2 No. 60079-11:14, ANSI/UL 60079-11 6th Edition between the intrinsically safe circuits that are associated with the M8 connectors to which the pressure and/or temperature transmitters are connected, and its enclosure. This shall be taken into account in any equipment installation. When considering this cognisance shall also be taken of Condition 7b).
- 7 Conditions associated with the digital temperature transmitter type EDT 87:
  - a) The capacity of free metal parts is  $C=24\text{pF}$ . This must be taken into account during installing the equipment.

b) The equipment does not meet the requirements of Clause 6.3 of IEC 60079-11:2011, CAN/CSA-C22.2 No. 60079-11:14, ANSI/UL 60079-11 6th Edition, this must be taken into account during installing the equipment.

- 8 Conditions associated with the Digital temperature transmitter type EDT 96:
- a) Under certain extreme circumstances, the plastic enclosure may store ignition-capable level of electrostatic charge. Therefore, the device shall not be installed in a location where the external conditions conducive to the build-up of electrostatic charge. The equipment shall only be cleaned with a damp cloth.

### 7.2 Opening and closing the electronics cover

#### Opening the electronics cover

- 1 Loosen the 4 screws on the electronics cover.
- 2 Open the electronics cover.



Fig. 4: Screws on the electronics cover

#### Closing the electronics cover

- 1 Close the electronics cover.
- 2 Retighten the four screws on the SPU cover that were previously loosened (3.5 Nm (2.58 lbf ft)).



### 7.3 Electrical connections

#### Electrical connections



- 1 M12 plug (service interface)
- 2 Cable gland (NPT 1/2")
- 3 Exterior ground terminal
- 4 Cable entries (NPT 1/2")

Fig. 5: Electrical connections

#### Terminal assignment

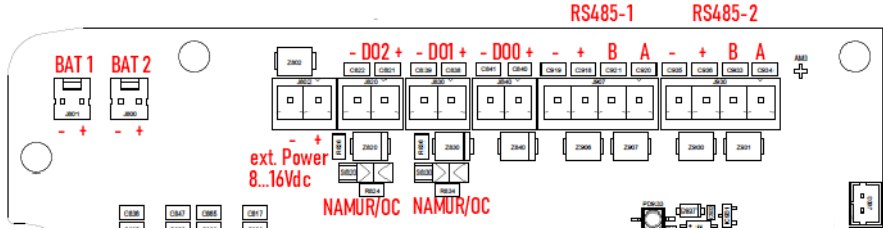



Fig. 3: Terminal assignment FLOWSIC550

**Operating parameters**

Input/output	Function/signal	Operating parameters
BAT1 “+”	Battery power supply	Battery Pack Article number: 2064018
BAT1 “-”		
BAT2 “+”	Battery power supply	Battery Pack Article number: 2064018
BAT2 “-”		
Ext. Power	External power supply	8 ... 16 V DC
DO0 “+”	Digital output DO0 “+”	NAMUR, electrically isolated
DO0 “-”	Digital output DO0 “-”	Maximum rated voltage 16 VDC I <sub>on</sub> = 3.6 mA @ 8.2V 1KΩ I <sub>off</sub> = 0.75 mA @ 8.2V 1KΩ
DO1 “+”	Digital output DO1 “+”	Passive, electrically isolated, configurable as:  OC (Open Collector): U = 3 VDC...16 VDC I <sub>MAX</sub> = 20 mA R <sub>ON</sub> < 10 Ω (U <sub>Drop</sub> < 1.5V) R <sub>OFF</sub> > 1 MΩ  or NAMUR: Maximum rated voltage 16 VDC I <sub>on</sub> = 3.6 mA @ 8.2V 1KΩ I <sub>off</sub> = 0.75 mA @ 8.2V 1KΩ
DO1 “-”	Digital output DO1 “-”	
DO2 “+”	Digital output DO2 “+”	
DO2 “-”	Digital output DO2 “-”	
	Grounding	

**Safety data of power supply**



**NOTICE:**

Only three operation modes are allowed:

- External power
- External power plus one battery pack (as backup)
- Two battery packs without external power

The use of all power inputs simultaneously is not allowed.

Terminal/Connector	Function	U <sub>i</sub> [V]	I <sub>i</sub> [mA]	P <sub>i</sub> [mW]	C <sub>i</sub> [nF]	L <sub>i</sub> [μH]
Ext. Power	External power supply	20	666	930	0	2.64

## Safety data of Inputs and outputs

Terminal	Function	active					passive				
		Uo [V]	Io [mA]	Po [mW]	Co [μF]	Lo [mH]	Ui [V]	Ii [mA]	Pi [mW]	Ci [μF]	Li [mH]
<b>Interfaces for interconnection with auxiliary equipment</b>											
D00	Digital output 0 optical isolated	--	--	--	--	--	20	--	1100	0.024	--
D01	Digital output 1	--	--	--	--	--	20	--	1100	0.024	--
D02	Digital output 2	--	--	--	--	--	20	--	1100	0.024	--
RS485 -1	RS485 Data interface, external [Ex ia] power sup- ply required	--	--	--	--	--	15	--	1100	IIA / D: 2.5 IIB / C, D: 1.5 IIC / A, B, C, D: 0.25	--
RS485 -2	RS485 Data interface, external [Ex ia] power sup- ply required	--	--	--	--	--	15	--	1100	IIA / D: 2.5 IIB / C, D: 1.5 IIC / A, B, C, D: 0.25	--
<b>Interface for interconnection with auxiliary service equipment</b>											
M12 connector	Service/Bluetooth Dongle	8.2	410	668	IIA / D: 1000 μF IIB / C, D: 81 μF IIC / A, B, C, D: 7.6 μF	0.165	n/a	n/a	n/a	n/a	n/a

### 7.3.1 Cable specifications

**WARNING: Electrical hazard**

- ▶ The cables and wires must be permanently installed. The plant operator must provide adequate strain relief.
  - ▶ Cables must have a permitted operating temperature of min. 70 °C (158 °F).
- 

**NOTICE: Requirements on cables and installation**

- ▶ Pay attention to the requirements in EN 60079-14 when selecting the cables and during installation!
  - ▶ Further legal requirements must be observed for use in explosive atmospheres.
  - ▶ Only copper wires may be used.
- 

**Cables**

- ▶ Protect cables especially endangered by thermal, mechanical or chemical stress, e.g. by laying in protective tubes.
- ▶ Cables must be flame-retardant according to DIN VDE 0472 Part 804. The fire behavior according to B / IEC 60332-1 must be approved.
- ▶ The existing air and creepage paths according to EN 60079-7 or EN 60079-15 may not be reduced by cable connections in the terminal box.
- ▶ Protect the wire ends with connector sleeves against fraying.
- ▶ Connect unused wires to ground or safeguard so that a short circuit with other conductive parts is excluded.
- ▶ Carry out potential equalization in accordance with EN 60079-14.

**RS485**

Supply voltage: 5 ... 10 VDC

Recommended cable cross section: 0.25 ... 1.5 mm<sup>2</sup>, twisted pair, shielded

Maximum cable length: 500 m total length

**Digital outputs**

Recommended cable cross section: 0.25 ... 1.5 mm<sup>2</sup>

**Pressure and temperature sensor**

Maximum cable length: 3 m

## 7.4 Battery operation

**WARNING: Hazard through wrong spare parts**

- ▶ Only the exchangeable battery packs from SICK with Part No. 2064018 may be used for the power supply of the device.
- ▶ Do not use damaged batteries; they must be disposed of correctly!

The battery packs are already inserted in the device.

Connect the batteries to the BAT1 and BAT2 terminals.

**Service life of battery packs**

Under typical operating conditions, the expected total service life of both battery packs is 5 years. Battery life may vary depending on the I/O configuration:

- In battery operation, preferably use DO\_1 and DO\_2 (LF + status or 2 times LF).
- Configure status outputs so that they are inactive during normal operation.
- If DO\_0 is active, the power consumption of the device is significantly increased. In battery operation, DO\_0 may only be used for status "Warning" and "Error".

The FLOWSIC550 needs more power:

- when the display is used frequently,
- when the Bluetooth interface is used frequently,
- when the serial data interface is used frequently.

The capacity of the batteries is reduced in unfavorable climatic conditions, for example when the temperatures are significantly higher or lower than 25 °C (77 ° F).

### 7.5 Installing the pressure and temperature sensor

#### Pressure sensor



**NOTICE:**

- The pressure measuring port to be used for measurement is marked "P<sub>M</sub>".
- The thread on the meter body is damaged when a wrong thread type is screwed in. When the meter body has an NPT 1/4" thread, screw in the adapter from NPT 1/4" to G1/4" (Part No. 2075562) before using the accessory parts available from SICK.



**NOTICE:**

Ensure sufficient clearance to the wall or other components at the rear measuring port when installing the sensor.

#### Temperature sensor

The temperature sensor must be installed in the customer's pipeline downstream of the measuring point.

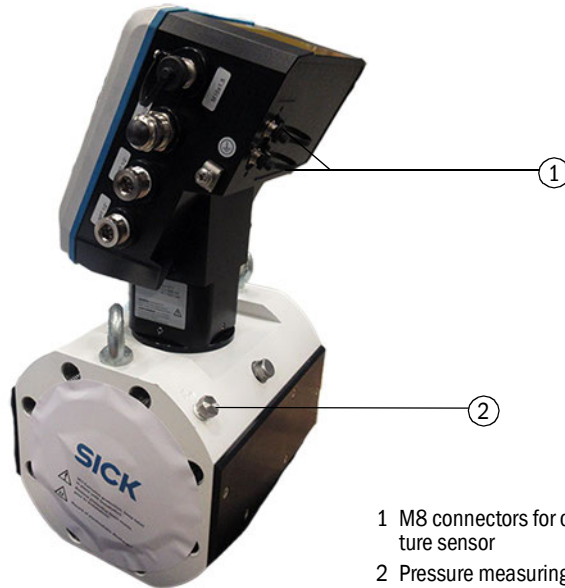

- 1 M8 connectors for connection of pressure and temperature sensor
- 2 Pressure measuring port "P<sub>M</sub>"

Fig. 6: Connecting the pressure and the temperature sensor



## 8 Commissioning

### 8.1 Important information

All activities described in “Mounting” and “Electrical installation” must be completed before commissioning.

### 8.2 Commissioning with the FLOWgate™ operating software

#### 8.2.1 Auxiliary means and accessories required

<p>FLOWgate™ is delivered with your measuring device or available on the SICK website.</p>  <p>Service adapter (M12/USB)</p>	<p>The current FLOWgate™ version is available via the following link:  <a href="https://www.sick.com/de/de/p/p484048">https://www.sick.com/de/de/p/p484048</a></p>  <p>Included in scope of delivery</p>
--	---

### 8.3 Connecting to the device

- 1 Install the FLOWgate™ operating software.
- 2 Connect the service adapter to the service interface (M12 plug) and to the USB interface of your computer.



Fig. 7: Service interface

- 3 Press the push button to activate the service interface.



Fig. 8: Push button



**Note:**

The display and the service interface have a timeout and switch off after approx. 5 minutes (default setting) when no button has been pressed and no data transmission takes place.

- 4 Click on the icon to start FLOWgate™:

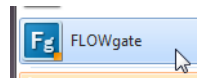

- 5 In FLOWgate™ click on icon “Scan” and scan for the device:



Default configuration of the service interface:  
Protocol type: MODBUS-RTU  
Baud rate: 38400  
Protocol bits: 8N1

- 6 When the device has been found, click on “Connect”.  
After successful login the Overview page is displayed.



8.3.1 Field setup wizard

8.3.1.1 Identification

**Device serials**

- ▶ Check the device serial numbers: Compare the entries against the type plate.

**Device data**

- ▶ Check the device serial numbers: Compare the entries against the type plate.

**Device information**

- ▶ Enter a device name: The device name is freely selectable.

**Location**

The GPS coordinates of the gas flow meter can also be entered as an option. This allows showing the location of the gas flow meter on Google maps.

8.3.1.2 System/user

**Device date and time**

Enter the date and time or synchronize with the PC.

**Device units**

The units are set at the factory as ordered. Check the settings and adapt if necessary.

**User management**



**NOTICE:**

SICK recommends changing the initial password provided for the administrator for security reasons.



Please refer to the delivery documentation for the device-specific administrator password. Otherwise the standard password for the Administrator is valid: 3333

Further users can be created here:

- ▶ Enter a user name.
  - ▶ Specify a password. The password must comprise 4 digits.
  - ▶ Activate the associated checkbox.
- Up to three users and authorized users can be created.

User	Activate	User Name	Password
User 1	<input checked="" type="checkbox"/>	Employee1	****
User 2	<input type="checkbox"/>	0	****
User 3	<input type="checkbox"/>	0	****
Authorized User 1	<input checked="" type="checkbox"/>	Employee2	****
Authorized User 2	<input type="checkbox"/>	0	****
Authorized User 3	<input type="checkbox"/>	0	****
Admin		Administrator	****

Fig. 9: Example: New users

### Power management

- ▶ Select the power management configuration “Battery powered”:  
“Battery powered”  
Self-sufficient power configuration: 2 internal longlife battery packs

### 8.3.1.3 Warnings

#### Warning limits

The standard limits for natural gas applications are set at the factory.  
Configure the warning limits as desired for your application.

#### User warnings activation

The warnings signalled by the device can be individually activated or deactivated. Activate single warnings as desired.

### 8.3.1.4 Archive/Logbooks

#### Logbooks

- ▶ Select the counter which is used for logbook entries.
- ▶ Configure the Event logbook:
  - Stopping: A warning is output when the logbook is full.
  - Rolling: The oldest entries are overwritten when the logbook is full.
- ▶ Activate or deactivate the Metrology logbook

#### Data archive settings

- ▶ The interval for the Diagnostic archive is set at the factory; default: 60 minutes

### 8.3.1.5 I/O Configuration

In the I/O configuration step, the parameters can be set for the interfaces available in accordance with the ordered configuration.

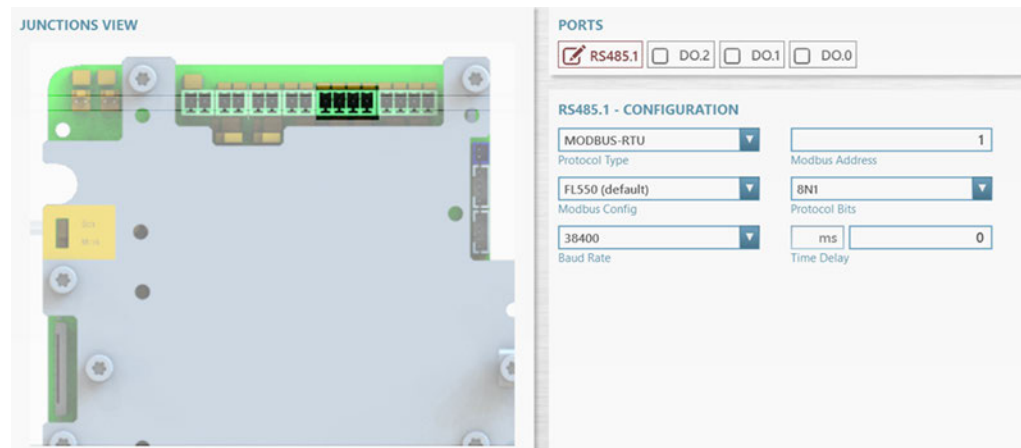

Fig. 10: Interface configuration

### 8.3.1.6 EVC (Electronic Volume Converter)



Only available for device option volume conversion

- ▶ Determine the reference values.
- ▶ Enter the specifications for gas characteristics.
- ▶ Select the algorithm and parameters for calculating the compressibility factor.

- ▶ Enter fixed values.

8.3.1.7 Finalize

**Finalize**

- ▶ If desired, reset the counters and clear the logbooks and the archive.



**Generate reports**

- ▶ SICK recommends creating a parameter report and archiving the report with the delivery documentation.

8.3.2 Function check after commissioning

Check the device status.

Table 3: Signaling the device status in FLOWgate™

Status	Description
	Normal operation, neither warnings nor errors exist
	Device status warning: At least one warning is pending in the device, the measured value is still valid.
	Device status error: At least one error is pending in the device, the measured value is invalid.

Click on the symbol in the Status bar when warnings or errors exist.

The current Status overview opens and shows details and information on how to proceed.

## 9 Operation

### 9.1 Operating using the display

- ▶ Press the push button to switch the display on.



**Note:**

The display and the serviceinterface have a timeout and switch off after approx. 5 minutes (default setting) when no button has been pressed and no data transmission takes place.



Fig. 4: Push button

#### Display elements

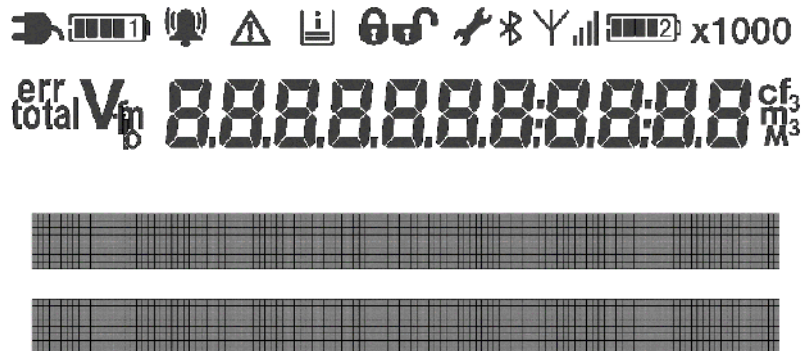

Fig. 5: Operating and display elements

#### Display test









Perform a display test by pressing the push button for 10 seconds.

## 9.2 Display in the symbol bar







**Note:**

If a value is measured under error conditions, the value is shown blinking on the display.

Symbol	Significance	Description
	External power supply	Displayed when the device is configured with external power supply.
	Meter Battery	Displayed when the device is configured for battery operation
	Device status: Malfunction	Blinking if the device has an error, the measured value is invalid.
	Device status: Warning	Blinking if device has a warning, the measured value is still valid.
	Registered events	Events have occurred since the last event summary reset.
	Parameter locking switch closed	Metrologically relevant parameters are protected against changing; modifications are registered in the Metrology logbook
	Parameter locking switch open	Metrologically relevant parameters can be changed; the modifications are not saved in the Metrology logbook.
	Configuration mode	Configuration mode is active, parameters can be changed.
	Bluetooth®	Bluetooth® is active.
x1000	Multiplier counter reading	Multiplier for the displayed counter reading.

## 9.3 Battery fill level display

The battery symbol changes as the battery is discharged.

Symbol	Description
	Battery fill level ≥ 75%
	Battery fill level ≥ 50%
	Battery fill level ≥ 25%
	Battery fill level ≥ 10%, the last segment of the battery symbol starts to blink when the battery fill level drops below 10%.

## 10 Maintenance

### 10.1 Maintenance work



**WARNING: Ignition hazard**

- ▶ To prevent ignition of flammable or combustible atmosphere, disconnect power (power supply and/or battery pack(s)) before servicing.



**NOTICE:**

Contact SICK if any maintenance work should become necessary.

### 10.2 Cleaning



**NOTICE: Cleaning information**

- ▶ Only clean the device with a damp cloth.
- ▶ Do not use solvents for cleaning.
- ▶ Only use materials for cleaning which do not damage the surface of the device.

### 10.3 Information on handling lithium batteries



**WARNING: Hazard through wrong spare parts**

- ▶ Only the exchangeable battery packs from SICK with Part No. 2064018 may be used for the power supply of the device.
- ▶ Do not use damaged batteries; they must be disposed of correctly!



**WARNING: Transporting battery packs by air freight**

- ▶ Comply with the national regulations when transporting used battery packs by air freight!

The battery packs are marked with important information concerning storage and disposal.

Table 4: Marking

Symbol	Significance
	Do not dispose with household trash.
	Recycling



Battery pack 2R20 cell type: TADIRAN SL-2880

SICK Part no.:2064018 Serial no.:  Date:

**WARNING:** Fire, explosion, and severe burn hazard. Do not recharge, disassemble, heat above 100°C, incinerate or expose contents to water.

**Disposal in EU:** Batteries shall be properly disposed and recycled according to guideline 2006/66/EC. Upon request a disposal service is offered by Tadiran Germany.

**Disposal in US:** Spent batteries shall be treated by an authorized, professional disposal company. It is recommended to contact the local EPA office. Refer to FLOWVIC500 user manual for further information.

Variable	Description
<input type="text" value="00"/>	Serial No.
<input type="text" value="01"/>	Date
<input type="text" value="02"/>	QR-Code → Order No. + <input type="text" value="00"/>

Fig. 11: Identification of battery packs

### 10.3.1 Information on storage and transport

- ▶ Prevent a short circuit of the battery terminals:
  - Store and transport the batteries in their original packaging
  - or tape the battery terminals.
- ▶ Store cool (under 21 °C (70 °F)), dry and without major temperature fluctuations.
- ▶ Protect against permanent sunlight.
- ▶ Do not store near the heating.

### 10.3.2 Disposal information

#### In the EU

- ▶ Dispose of lithium batteries in accordance with the Battery Directive 2006/66/EU.
- ▶ In Germany, you can hand in the batteries at your local recycling center. Alternatively, the battery manufacturer Tadiran Germany offers a return service on request.

Contact data:

Phone: +49 (0)6042/954-122

Fax: +49 (0)6042/954-190

[www.tadiranbatteries.de](http://www.tadiranbatteries.de)

#### In the USA

- ▶ Batteries have to be disposed of by an authorized waste disposal company. Identification of lithium batteries:
  - Proper shipping name: Waste lithium batteries
  - UN number: 3090
  - Label requirements: MISCELLANEOUS, HAZARDOUS WASTE
  - Disposal code: D003
- ▶ If anything is unclear, contact the local office of the Environmental Protection Agency (EPA).

#### In other countries

Please observe national regulations for the disposal of lithium batteries.

### 11 Troubleshooting

#### 11.1 Contacting customer service



**NOTICE:**

Contact the manufacturer if any malfunctions, errors or warnings occur.

---



## 12 Decommissioning

### 12.1 Safety information on decommissioning

Ensure that all safety instructions are observed:

- see “For your safety”, page 8
- see “Mounting”, page 20
- see “Electrical installation”, page 23

### 12.2 Return delivery

#### 12.2.1 Contact

Contact your local SICK representative for assistance.

#### 12.2.2 Clearance certificate

A clearance certificate will be provided by your local SICK representative, if necessary.

#### 12.2.3 Packaging

Make sure, the measuring device cannot be damaged during transport.

13 Technical data

13.1 Dimension drawings

Dimensions FLOWSIC550

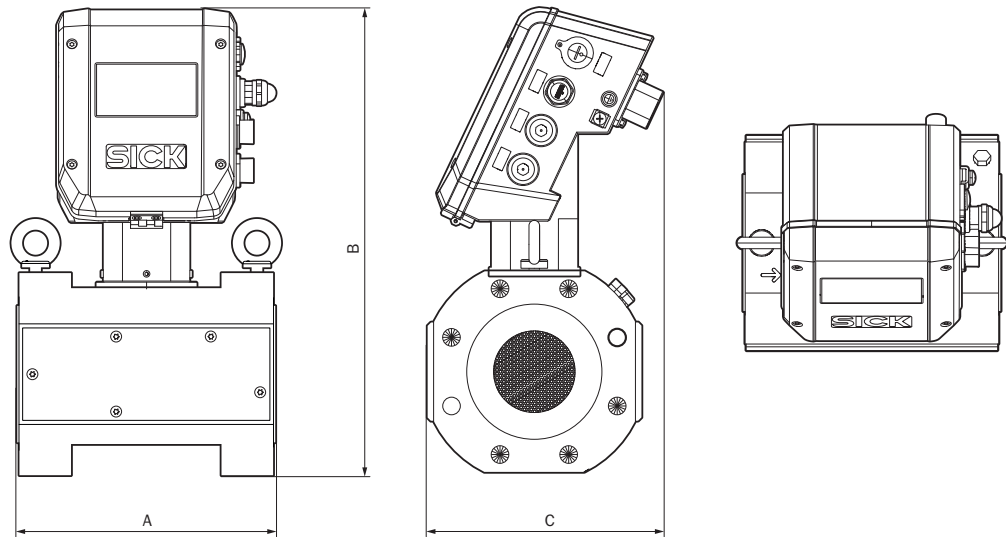

Table 5: Dimensions in mm [in]

Nominal size	A	B	C
DN50/2"	150 [5.9]	425 [16.73]	220 [8.66]
DN80/3"	240 [9.45]	425 [16.73]	220 [8.66]

## 13.2 Technical data

Table 6: Technical data FLOWSIC550

Measuring parameters		
Measured values	Volume a.c., volume flow a.c., gas velocity In addition, for integrated volume correction: volume s.c., volume flow s.c.	
Number of measuring paths	2	
Nominal pipe size	DN50/2", DN80/3", upcoming: DN100/4", DN150/6"	
Measurement principle	Ultrasonic transit time difference measurement	
Measuring medium	Natural gas (dry, odorized), blended up to 30% H <sub>2</sub> , air	
Measuring ranges	Volume flow a.c., DN50/2"	2.5 m <sup>3</sup> /h ... 200 m <sup>3</sup> /h 88 cfh ... 7062 cfh
	Volume flow a.c., DN80/3"	6.4 m <sup>3</sup> /h ... 500 m <sup>3</sup> /h 226 cfh ... 17660 cfh
	Volume flow a.c., DN100/4"	Upcoming
	Volume flow a.c., DN150/6"	Upcoming
Repeatability	≤ 0.1%	
Accuracy	Accuracy class 1; maximum allowed error limits Q <sub>min</sub> up to 0.08 Q <sub>max</sub> : ≤ ± 2% 0.08 Q <sub>max</sub> up to Q <sub>max</sub> : ≤ ± 1%	
Min. piping requirements	3D straight inlet and 2D outlet	
Material	Meter body: low-temperature carbon steel SPU: cast aluminum	
Approvals		
Ex	Certificate	NEC/CEC: CSA 22CA80143220
	Marking	Class I, Division 1, Groups C, D T4 Ex ia [ia Ga] IIB T4 Gb Class I, Zone 1 AEx ia [ia Ga] IIB T4 Gb
	Applied Standards	ANSI/UL 60079-0 Ed. 7 ANSI/UL 60079-11 Ed. 6 ANSI/UL 913 Ed. 8
Enclosure rating	IP66, Type 3R	
Dimensions and weight		
Dimensions	See dimension drawings	
Weight	DN50/2": 26 kg (55 lbs) DN80/3": 46 kg (101 lbs)	
Ambient conditions		
Ambient temperature	-40 °C...+70 °C (-40 °F...+158 °F)	
Storage temperature	-40 °C...+70 °C (-40 °F...+158 °F)	
Ambient pressure	80 kPa (0.8 bar) .... 110 kPa (1.1 bar)	
Ambient humidity	≤ 95 % relative humidity; non-condensing	
Installation	Horizontally or vertically	
Installation location	Indoor, outdoor	

Measuring conditions	
Operating pressure	ANSI300 (ASME B16.5):
	5 bar(g)... 48.6 bar(g) for 70 °C 5 bar(g)... 51 bar(g) for -40 °C ... 38 °C
	72.5 psi(g) .... 705 psi(g) for 158 °F 72.5 psi(g) .... 740 psi(g) for -40 °F ... 100 °F
	ANSI600 (ASME B16.5):
	5 bar(g)... 97.2 bar(g) for 70 °C 5 bar(g)... 102 bar(g) for -40 °C ... 38 °C
	72.5 psi(g) .... 1,410 psi(g) for 158 °F 72.5 psi(g) .... 1,480 psi(g) for -40 °F ... 100 °F
Pressure ranges valid for natural gas, meter operation possible at ambient pressure for air	
Gas temperature	-40 °C ... +70 °C (-40 °F...+158 °F)
Electrical connections	
Power supply	8...16 V DC, max. 50 mA
Power consumption	< 1 W
Outputs and interfaces	
Serial RS485	✓ Quantity: 2 Data protocol: Modbus RTU
Digital outputs	✓ Quantity: 2 Pulse, 1 Status
Display	LCD: Measured variables, system information, warnings, maintenance requests, alarms
Battery	
Battery type	Battery pack 2R20 → 6050492 Tadiran SL-2880
Battery chemistry	Lithium thionyl chloride cell → Li/SOCl <sub>2</sub>

Table 7: Technical Data (additional for device option volume conversion)

Volume conversion	
Accuracy	Accuracy class 0.5 Maximum allowed error limit of conversion factor C: $\leq \pm 0.5\%$ (at reference conditions)
Conversion method	PTZ
Calculation methods	<ul style="list-style-type: none"> <li>• Fixed value</li> <li>• SGERG88,</li> <li>• AGA 8 Gross method 1</li> <li>• AGA 8 Gross method 2</li> <li>• AGA NX-19</li> </ul> <ul style="list-style-type: none"> <li>• AGA NX-19 mod.</li> <li>• AGA NX-19 mod. GOST</li> <li>• GERG91 mod.</li> </ul>
Pressure sensor	
Measuring ranges	Relative pressure sensors
	0 ... 70 bar (g) (0 ... 1015 psi(g))
	0 ... 103.46 bar(g) (0 ... 1500 psi(g))
Temperature sensor	
Measuring ranges	-40 °C...+70 °C (-40 °F...+158 °F)

### 13.3 Application ranges

#### Pressure loss

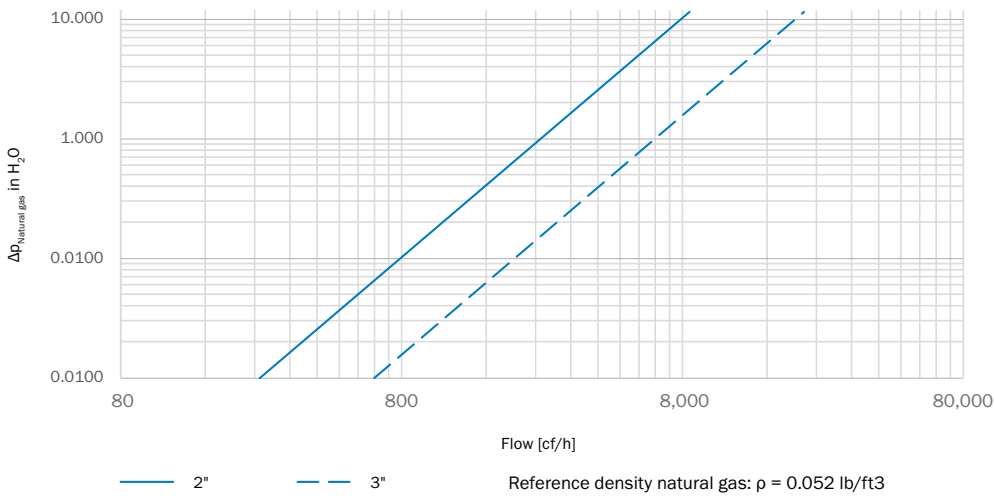

14 Annex

14.1 Type plates

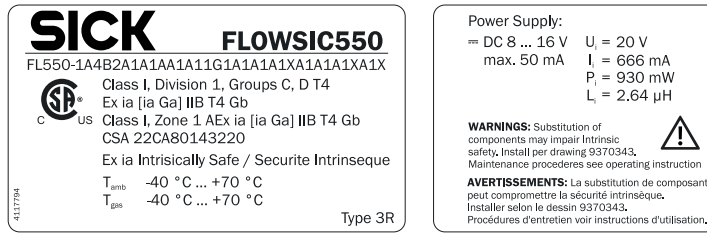

Fig. 12: CSA type plate (example)

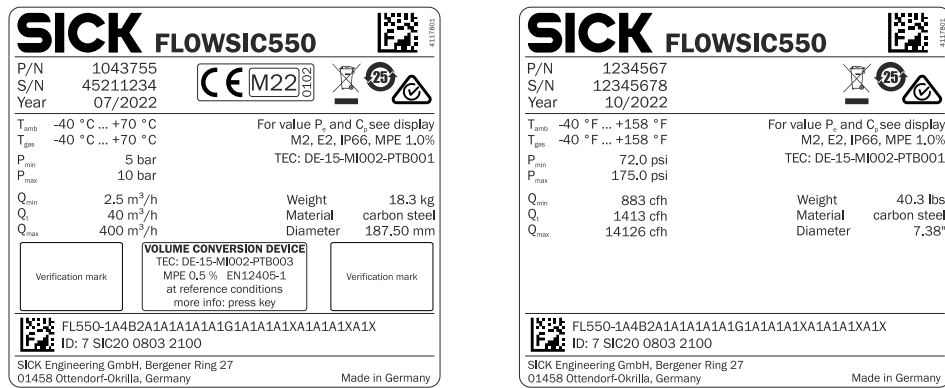

Fig. 13: Main type plate (examples)

14.2 Control drawing

**[Ex ia] Associated Equipment**  
 Only for interconnection with an ExI equipment or an [ExI] associated equipment  
 Entity parameters of interconnected equipments must be compiled as follows:  
 Uo < Ui, Io < Ii, Po < Pi, Co > Ci + Ccable, Lo > Ll + Lcable

**Entity parameters for connections in the ExI terminal compartment**

Terminal	Function	Ui [V]	Ii [mA]	Pi [mW]	Ci [nF]	Ll [μH]
Ext. Power	external power supply	20	666	930	0	2.64

Terminal	Function	active						passive					
		Uo [V]	Io [mA]	Po [mW]	Co [μF]	Lo [mH]	Li [μH]	Ui [V]	Ii [mA]	Pi [mW]	Ci [μF]	Ll [mH]	
<b>Interfaces for interconnection with auxiliary equipment or field wiring</b>													
DO0	Encoder optical isolated	---	---	---	---	---	20	n/a	1100	0.024	---		
DO1	Digital output 1 optical isolated	---	---	---	---	---	20	n/a	1100	0.024	---		
DO2	Digital output 2 optical isolated	---	---	---	---	---	20	n/a	1100	0.024	---		
RS485-1	RS485 Data interface external [Ex ia] power supply required	---	---	---	---	---	15	n/a	1100	IIA / D: 2.5 IIB / C, D: 1.5 IIC / A, B, C, D: 0.25	---		
RS485-2	RS485 Data interface external [Ex ia] power supply required	---	---	---	---	---	15	n/a	1100	IIA / D: 2.5 IIB / C, D: 1.5 IIC / A, B, C, D: 0.25	---		
<b>Interface for interconnection with auxiliary service equipment</b>													
M12 Connector	Service/Bluetooth Dongle	8.2	410	668	IIA / D: 1000 μF IIB / C, D: 81 μF IIC / A, B, C, D: 7.6 μF	0.165	n/a	n/a	n/a	n/a	n/a	n/a	

n/a: denotes not relevant and needed not to be applied

For further informationen see Operating Instructions (no. 8027872).

**Class I Division 1, Groups D / C, D / A, B, C, D T4**  
**Ex ia [ia Ga] IIA / IIB / IIC T4 Gb**  
**Class I, Zone 1 AEx ia [ia Ga] IIA / IIB / IIC T4 Gb**  
**-40 °C < Tamb < 70 °C**

In the US: install in accordance with the NEC (NFPA70, Article 504)  
 in Canada install in accordance with CEC part 1  
 an IANS/MSAR-P1 (2.06.01)

Exia Intrinsically Safe; Sécurité Intrinsèque

**WARNING: EXPLOSION HAZARD**  
 Substituting components may impair intrinsic safety  
 AVERTISSEMENT: RISQUE D'EXPLOSION - La substitution  
 de composants peut compromettre la sécurité intrinsèque.

DATE	NAME	TITLE
2022.10.25	scheisy	CONTROL DRAWING FLOWSIC550
2023.04.12	scheisy	CONTROL DRAWING FLOWSIC550

DRAWING NUMBER	SHEET NO.
9370343	1 of 5

TYPE/DIN	MATERIAL	ORIGIN	REPLACES	SIZE
FL550	see BOM			A4

Fig. 14: Control drawing 9370343 (page 1/5)

8027872/1JTM/0-8/2023-05 | SICK  
 Subject to change without notice

OPERATING INSTRUCTIONS | FLOWSIC550

47

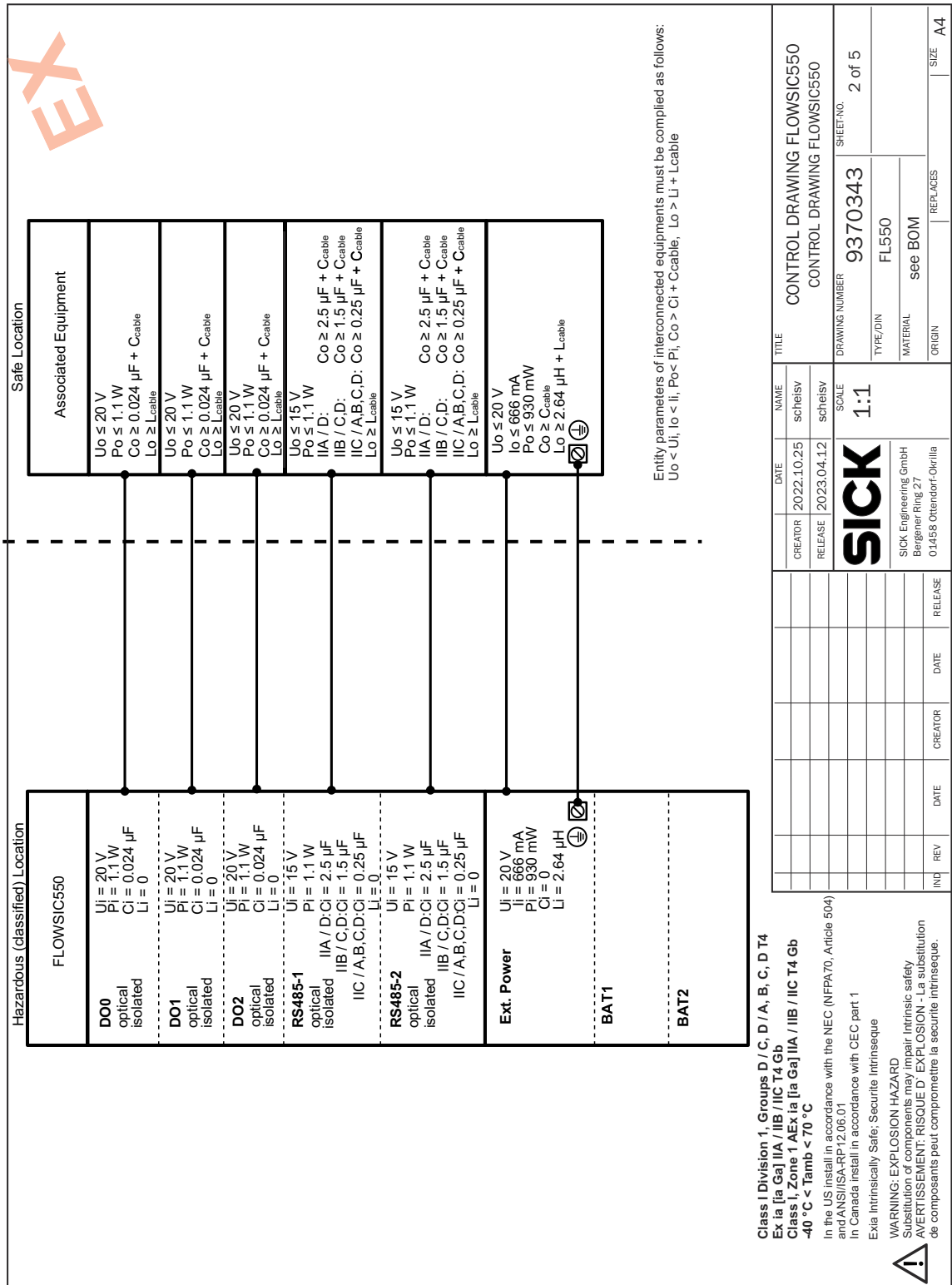

**Class I Division 1, Groups D / C, D / A, B, C, D T4**  
**Ex ia [ia Ga] IIA / IIB / IIC T4 Gb**  
**Class I, Zone 1 AEx ia [ia Ga] IIA / IIB / IIC T4 Gb**  
**-40 °C < Tamb < 70 °C**

In the US install in accordance with the NEC (NFPA70, Article 504) and ANSI/ISA-RP-12.06.01  
 In Canada install in accordance with CEC part 1  
 Ex ia Intrinsically Safe; Securite intrinseque

**WARNING: EXPLOSION HAZARD**  
 Substitution of components may impair intrinsic safety  
 AVERTISSEMENT: RISQUE D'EXPLOSION - La substitution de composants peut compromettre la securite intrinseque.

CREATOR	2022.10.25	NAME	scheisy	TITLE	CONTROL DRAWING FLOWSIC550
RELEASE	2023.04.12	SCALE	scheisy	DRAWING NUMBER	9370343
<b>SICK</b>			SCALE	1:1	SHEET NO.
SICK Engineering GmbH Bergener Ring 27 01455 Ottendorf-Okrilla				TYPE/DIN	2 of 5
				MATERIAL	FL550
				ORIGIN	see BOM
				REPLACES	
				SIZE	A4

Fig. 15: Control drawing 9370343 (page 2/5)



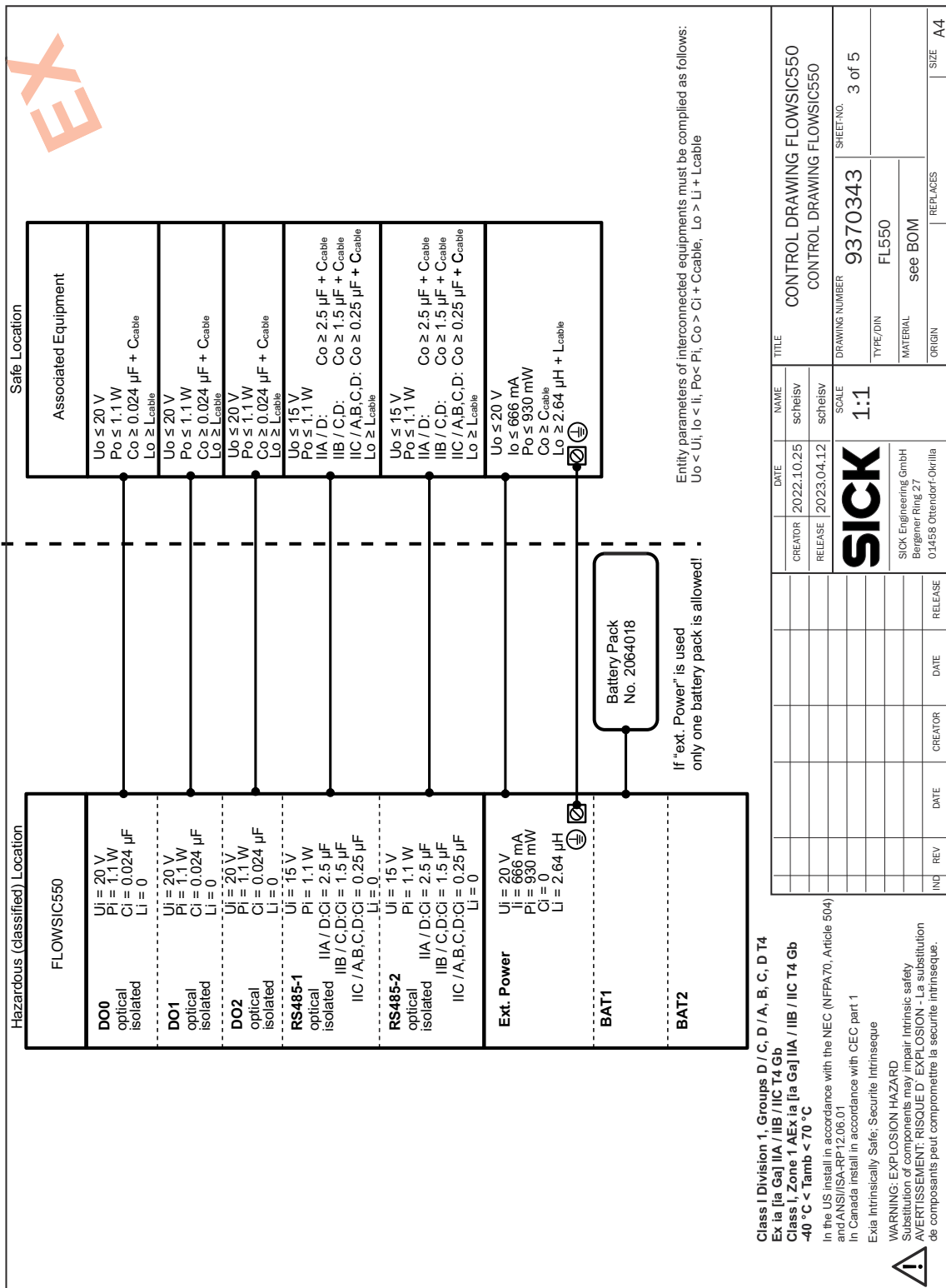

Fig. 16: Control drawing 9370343 (page 3/5)

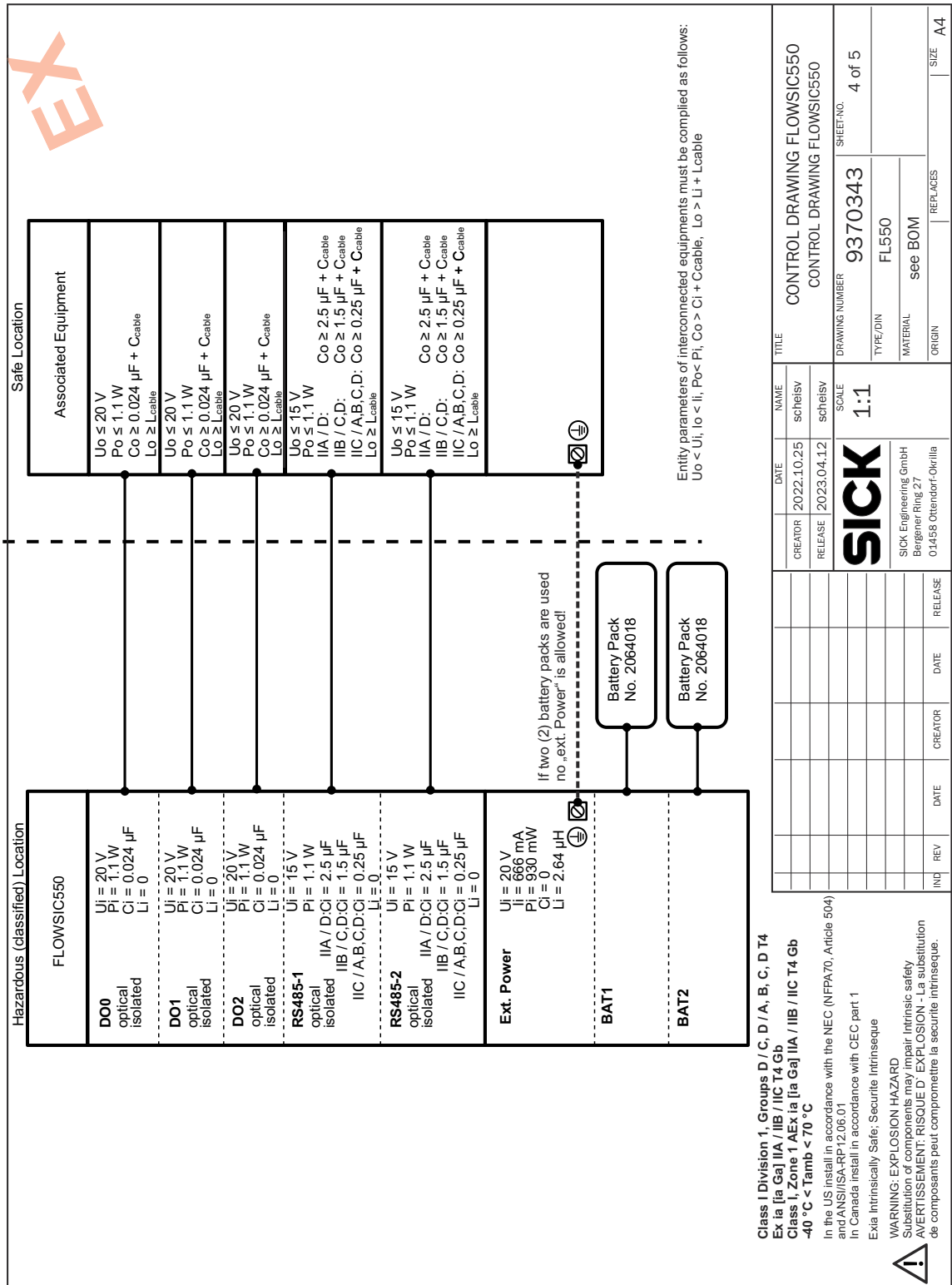

Fig. 17: Control drawing 9370343 (page 4/5)

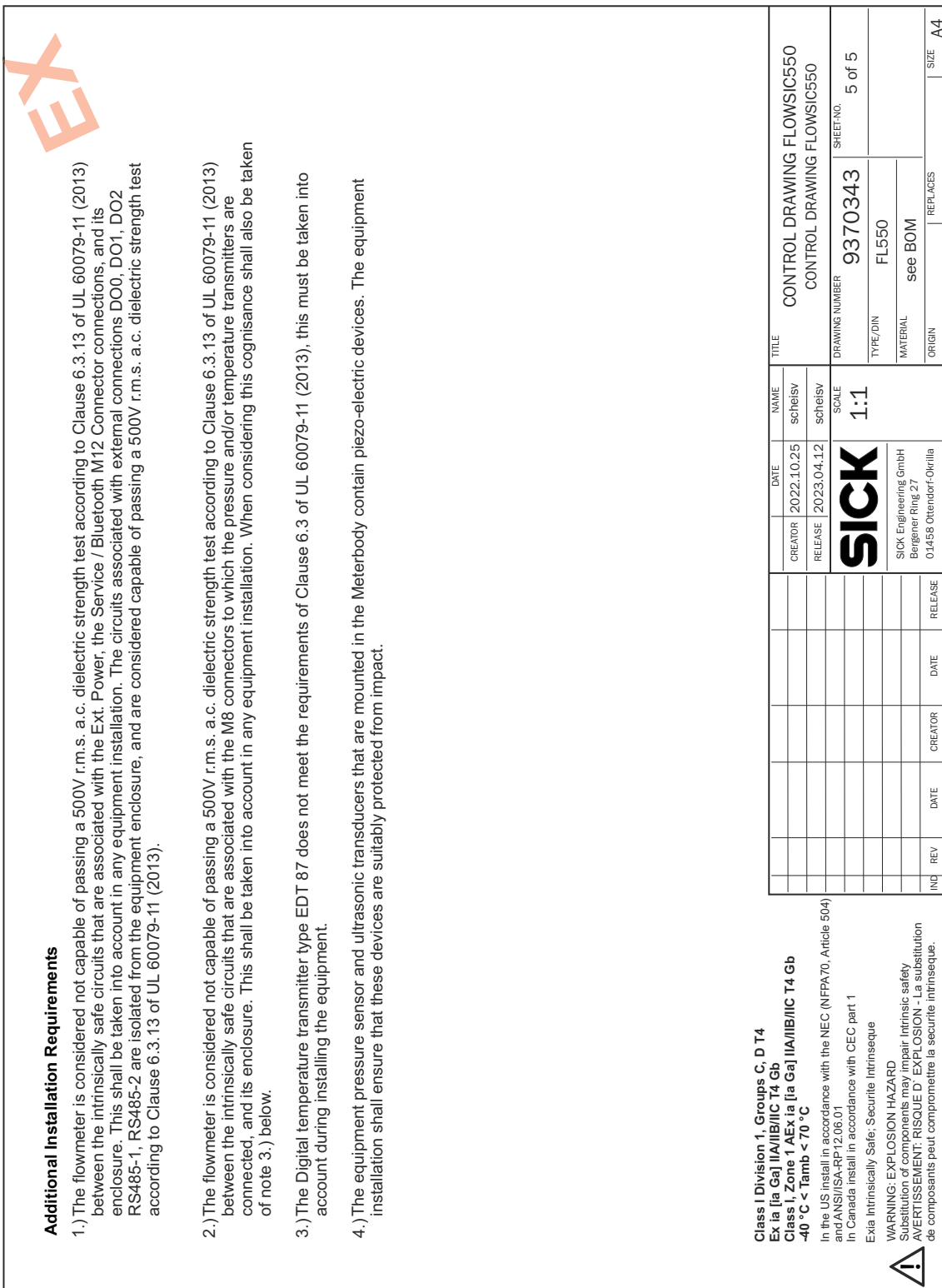

Fig. 18: Control drawing 9370343 (page 5/5)

**Australia**

Phone +61 (3) 9457 0600  
1800 33 48 02 – tollfree  
E-Mail sales@sick.com.au

**Austria**

Phone +43 (0) 2236 62288-0  
E-Mail office@sick.at

**Belgium/Luxembourg**

Phone +32 (0) 2 466 55 66  
E-Mail info@sick.be

**Brazil**

Phone +55 11 3215-4900  
E-Mail comercial@sick.com.br

**Canada**

Phone +1 905.771.1444  
E-Mail cs.canada@sick.com

**Czech Republic**

Phone +420 234 719 500  
E-Mail sick@sick.cz

**Chile**

Phone +56 (2) 2274 7430  
E-Mail chile@sick.com

**China**

Phone +86 20 2882 3600  
E-Mail info.china@sick.net.cn

**Denmark**

Phone +45 45 82 64 00  
E-Mail sick@sick.dk

**Finland**

Phone +358-9-25 15 800  
E-Mail sick@sick.fi

**France**

Phone +33 1 64 62 35 00  
E-Mail info@sick.fr

**Germany**

Phone +49 (0) 2 11 53 010  
E-Mail info@sick.de

**Greece**

Phone +30 210 6825100  
E-Mail office@sick.com.gr

**Hong Kong**

Phone +852 2153 6300  
E-Mail ghk@sick.com.hk

**Hungary**

Phone +36 1 371 2680  
E-Mail ertekesites@sick.hu

**India**

Phone +91-22-6119 8900  
E-Mail info@sick-india.com

**Israel**

Phone +972 97110 11  
E-Mail info@sick-sensors.com

**Italy**

Phone +39 02 27 43 41  
E-Mail info@sick.it

**Japan**

Phone +81 3 5309 2112  
E-Mail support@sick.jp

**Malaysia**

Phone +603-8080 7425  
E-Mail enquiry.my@sick.com

**Mexico**

Phone +52 (472) 748 9451  
E-Mail mexico@sick.com

**Netherlands**

Phone +31 (0) 30 229 25 44  
E-Mail info@sick.nl

**New Zealand**

Phone +64 9 415 0459  
0800 222 278 – tollfree  
E-Mail sales@sick.co.nz

**Norway**

Phone +47 67 81 50 00  
E-Mail sick@sick.no

**Poland**

Phone +48 22 539 41 00  
E-Mail info@sick.pl

**Romania**

Phone +40 356-17 11 20  
E-Mail office@sick.ro

**Russia**

Phone +7 495 283 09 90  
E-Mail info@sick.ru

**Singapore**

Phone +65 6744 3732  
E-Mail sales.gsg@sick.com

**Slovakia**

Phone +421 482 901 201  
E-Mail mail@sick-sk.sk

**Slovenia**

Phone +386 591 78849  
E-Mail office@sick.si

**South Africa**

Phone +27 10 060 0550  
E-Mail info@sickautomation.co.za

**South Korea**

Phone +82 2 786 6321/4  
E-Mail infokorea@sick.com

**Spain**

Phone +34 93 480 31 00  
E-Mail info@sick.es

**Sweden**

Phone +46 10 110 10 00  
E-Mail info@sick.se

**Switzerland**

Phone +41 41 619 29 39  
E-Mail contact@sick.ch

**Taiwan**

Phone +886-2-2375-6288  
E-Mail sales@sick.com.tw

**Thailand**

Phone +66 2 645 0009  
E-Mail marcom.th@sick.com

**Turkey**

Phone +90 (216) 528 50 00  
E-Mail info@sick.com.tr

**United Arab Emirates**

Phone +971 (0) 4 88 65 878  
E-Mail contact@sick.ae

**United Kingdom**

Phone +44 (0)17278 31121  
E-Mail info@sick.co.uk

**USA**

Phone +1 800.325.7425  
E-Mail info@sick.com

**Vietnam**

Phone +65 6744 3732  
E-Mail sales.gsg@sick.com

Detailed addresses and further locations at [www.sick.com](http://www.sick.com)