

SSM-ICON

Static smart meter

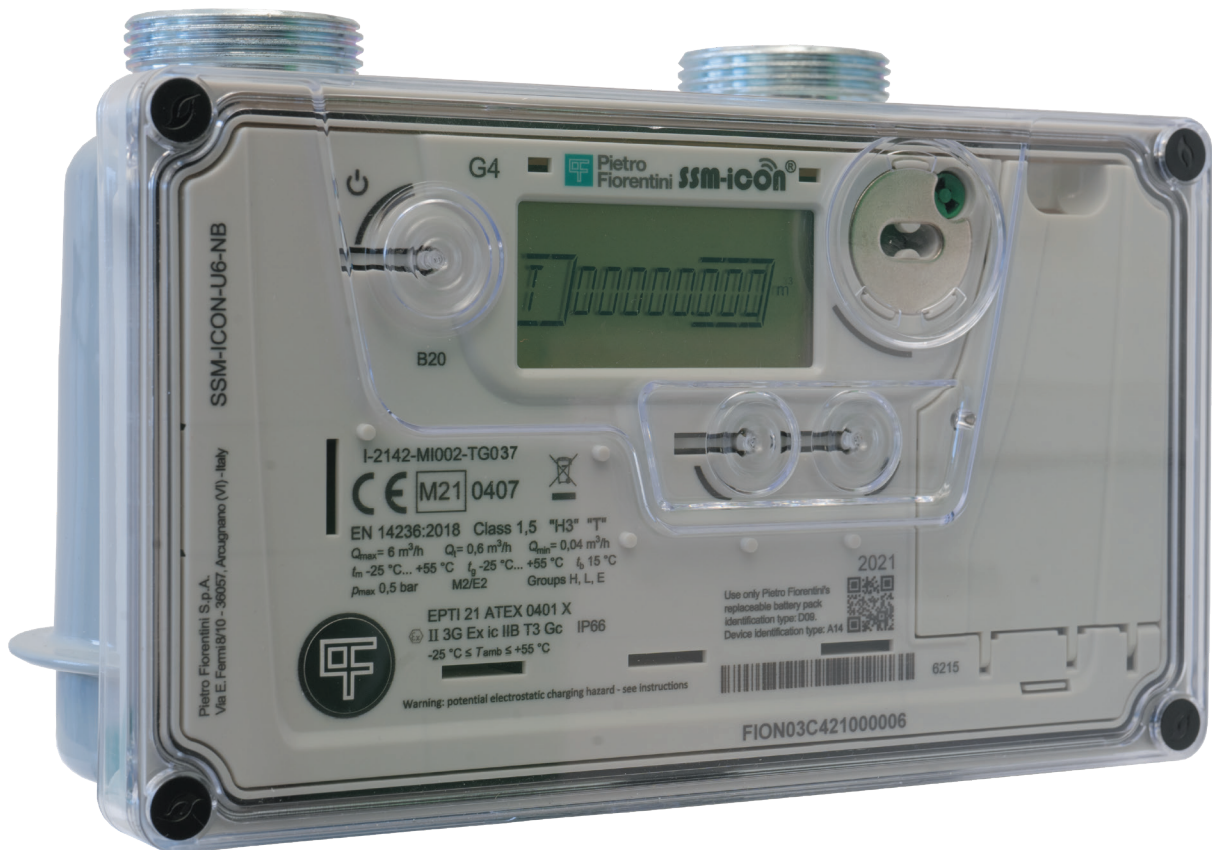

Revision B – Edition 10/2022

**USE, MAINTENANCE
AND WARNING
MANUAL**

1 - INTRODUCTION

FOREWORD

All rights reserved. No part of this publication may be reproduced, distributed, translated into other languages or transmitted by any electronic or mechanical media, including photocopies, recording or any other storage and retrieval system, for any other purposes that are not exclusively the personal use of the buyer, without the express written permission of the Manufacturer.

The manufacturer is in no way responsible for the consequences of operations carried out in a manner not in accordance with the manual.

GENERAL CONSIDERATIONS

All the operating, maintenance instructions and recommendations described in this manual must be adhered to in order to:

- obtain the best possible performance from the equipment;
- keep the equipment in efficient conditions.

Training the personnel in charge is essential in order to:

- use and service the equipment properly;
- correctly apply the safety alerts and procedures recommended.

NOTICE!

The images shown in this document indicate the type of product and may differ in detail.

Revision: B

1.1 - REVISION HISTORY

Revision index	Date	Revision contents
C	10/2022	First issue
B	02/2022	Changed name SSM-iCON > SSM-ICON Chap. 1: added note in foreword Par. 4.1.4: edited paragraph (Acquisition) Par. 4.3: changes in tab. 4.20 (Technical data) Par. 2.8.1.1: changes in tab. 2.9 (Type of gauge) Par. 2.8.1.2: changes in tab. 2.10 (Type of remote communication) Par. 3.6: edited paragraph (Safety and anti-fraud)

Tab. 1.1.

TABLE OF CONTENTS

1 - INTRODUCTION	3
1.1 - REVISION HISTORY.....	5
2 - GENERAL INFORMATION	11
2.1 - MANUFACTURER IDENTIFICATION	11
2.2 - IDENTIFICATION OF THE PRODUCT	11
2.3 - REGULATORY FRAMEWORK.....	12
2.4 - WARRANTY	12
2.4.1 - REFERENCE OPERATING CONDITIONS	13
2.5 - ADDRESSEES, SUPPLY AND STORAGE OF THE MANUAL	14
2.6 - LANGUAGE	14
2.7 - SYMBOLS USED IN THE MANUAL.....	15
2.8 - NAMEPLATES APPLIED	16
2.8.1 - IDENTIFIER OF THE LOGIC DEVICE	17
2.8.1.1 - TYPE OF GAUGE	17
2.8.1.2 - REMOTE COMMUNICATION TYPE	17
2.8.2 - DESCRIPTION OF THE NAMEPLATES.....	18
2.9 - GLOSSARY OF MEASUREMENT UNITS.....	19
2.10 -QUALIFIED PROFESSIONAL FIGURES.....	20
3 - SAFETY	21
3.1 - GENERAL SAFETY WARNINGS.....	21
3.2 - ATEX DIRECTIVE SAFETY INSTRUCTIONS	22
3.2.1 - ELECTROSTATIC DISCHARGES.....	22
3.2.2 - CONNECTING TO OTHER DEVICES.....	22
3.2.3 - POWER SUPPLY DEVICES	22
3.2.4 - SAFETY INSTRUCTIONS FOR INSTALLATION IN HAZARDOUS AREA	23
3.3 - PERSONAL PROTECTIVE EQUIPMENT	24
3.4 - OBLIGATIONS AND PROHIBITIONS	25
3.5 - RESIDUAL RISKS	26
3.5.1 - RISK OF ELECTROSTATIC DISCHARGE.....	26
3.6 - SAFETY AND FRAUD PREVENTION	27
3.7 - SAFETY PICTOGRAMS	28
3.8 - RISK LEVEL	28

4 - DESCRIPTION AND OPERATION 29

4.1 - GENERAL DESCRIPTION	29
4.1.1 - POWER SUPPLY DEVICES	30
4.1.1.1 - CONNECTION OF THE POWER SUPPLY DEVICES	30
4.1.1.2 - POWER SUPPLY STATUS	30
4.1.2 - SHUT-OFF VALVE (OPTIONAL).....	31
4.1.3 - ACQUISITION OF THE MEASURE.....	32
4.1.4 - EVENTS AND DIAGNOSTICS.....	32
4.1.5 - ACTIVATION AND CONFIGURATION.....	32
4.1.6 - COMMUNICATION INTERFACES	32
4.1.7 - USER INTERFACE.....	32
4.2 - INTENDED USE	33
4.2.1 - ENVISAGED USE	33
4.2.2 - REASONABLY FORESEEABLE MISUSE	33
4.3 - TECHNICAL DATA	34

5 - USER INTERFACE 35

5.1 - GENERAL DESCRIPTION	35
5.2 - LCD DISPLAY DESCRIPTION	36
5.3 - NAVIGATION PROCEDURE	38
5.3.1 - DEFAULT CHAPTER (CURRENT RATE PERIOD).....	39
5.3.2 - CHAPTER SELECTION	39
5.3.3 - CHAPTER 1 (PREVIOUS BILLING PERIOD).....	40
5.3.4 - CHAPTER 2 (MAIN PARAMETERS)	40
5.3.4.1 - SUB-MENU OF THE FIRMWARE DEVICE AND THE OPERATING STATUS	41
5.3.5 - CHAPTER 3 (SERVICE)	42
5.3.6 - CHAPTER 4 (COMMUNICATION).....	43
5.4 - ALARMS	43
5.5 - OPTIONAL SHUT-OFF VALVE OPENING.....	44

6 - TRANSPORT AND HANDLING	45
6.1 - SPECIFIC WARNINGS FOR TRANSPORT AND HANDLING	45
6.1.1 - PACKAGING AND FASTENERS USED FOR TRANSPORT	45
6.2 - PACKAGING CONTENT	46
6.3 - PHYSICAL CHARACTERISTICS OF THE EQUIPMENT	47
6.4 - EQUIPMENT ANCHORING AND LIFTING METHOD.....	48
6.4.1 - FORKLIFT HANDLING METHOD.....	49
6.5 - PACKAGING REMOVAL.....	51
6.5.1 - PACKAGING DISPOSAL	51
6.6 - STORAGE AND ENVIRONMENTAL CONDITIONS	52
6.6.1 - STORAGE OF THE SPARE BATTERIES	52
7 - INSTALLATION	53
7.1 - GENERAL WARNINGS	53
7.2 - INSTALLATION PRE-REQUISITES.....	53
7.2.1 - ALLOWED ENVIRONMENTAL CONDITIONS.....	53
7.3 - CHECKS BEFORE INSTALLATION.....	54
7.4 - SPECIFIC SAFETY INSTRUCTIONS FOR THE INSTALLATION STEP	55
7.5 - INSTALLATION PROCEDURE	56
7.6 - EQUIPMENT ADJUSTMENTS.....	57
8 - CONFIGURATION	59
8.1 - SAFETY REQUIREMENTS FOR CONFIGURATION	59
8.2 - EQUIPMENT CONFIGURATION	59
8.2.1 - USING THE OPTICAL PROBE.....	59
8.3 - VERIFY CORRECT CONFIGURATION.....	59
8.4 - CONNECTING TO OTHER DEVICES	59
9 - MAINTENANCE AND FUNCTIONAL CHECKS.....	61
9.1 - GENERAL WARNINGS	61
9.2 - SPECIAL MAINTENANCE	62
9.2.1 - REPLACING THE COMMUNICATION BATTERY PACK	62
9.2.2 - SIM REPLACEMENT (ONLY FOR SSM-ICON-GPRS AND SSM-ICON-NB) VERSIONS)	65

10 - UNINSTALLATION AND DISPOSAL 67

10.1 -GENERAL SAFETY WARNINGS.....	67
10.2 -QUALIFICATION OF THE OPERATORS IN CHARGE.....	67
10.3 -UNINSTALLATION.....	67
10.4 -INFORMATION REQUIRED IN CASE OF NEW INSTALLATION.....	68
10.5 -STORAGE OF THE BATTERIES	68
10.6 -INFORMATION REQUIRED IN CASE OF RE-INSTALLATION.....	68
10.7 -DISPOSAL INFORMATION.....	69
10.7.1 - DISPOSING OF THE BATTERIES	70
10.7.1.1 - BATTERY PACKAGING.....	70

11 - RECOMMENDED SPARE PARTS 71

11.1 -GENERAL WARNINGS	71
11.2 -HOW TO REQUEST SPARE PARTS.....	71
11.3 -SPARE PARTS LIST	72
11.4 -PUTTING BACK BATTERIES.....	72

PAGE INTENTIONALLY LEFT BLANK

2 - GENERAL INFORMATION

2.1 - MANUFACTURER IDENTIFICATION

Manufacturer	PIETRO FIORENTINI S.P.A.
Address	Via Enrico Fermi, 8/10 36057 Arcugnano (VI) - ITALY Tel. +39 0444 968511 Fax +39 0444 960468 www.fiorentini.com sales@fiorentini.com

Tab. 2.2.

NOTICE!

For any problem encountered on the equipment, contact the distributor of the reference gas mains.

2.2 - IDENTIFICATION OF THE PRODUCT

Equipment	STATIC SMART METER
Series	SSM-ICON
Available models	<ul style="list-style-type: none"> • SSM-ICON-U6-GPRS • SSM-ICON-U6-169 • SSM-ICON-U6-NB <div style="border: 1px solid black; padding: 5px; margin-top: 10px;"> <h4> NOTICE!</h4> <p>The same models are also available in the “EL” (“Extended Life”) version.</p> </div>

Tab. 2.3.

2.3 - REGULATORY FRAMEWORK

PIETRO FIORENTINI S.P.A. with registered office in Arcugnano (Italy) - Via E. Fermi, 8/10, declares that the equipment of the SSM-ICON series described in this manual is designed, manufactured, tested and checked in compliance with:

- the requirements of the Directives:
 - 2014/32/EU “MID”;
 - 2014/34/EU “ATEX”;
 - 2014/53/EU “RED”;
 - 2011/65/UE “RoHS 2”;
 - 2012/19/EU “WEEE”;
- resolution 631/2013/R/gas of the Regulatory Authority for Energy, Networks and Environment (ARERA) and ratified in the UNI/TS 11291 package of standards.

NOTICE!

For specific type approvals, see the appropriate section on the Manufacturer’s website: <https://www.fior-entini.com>

NOTICE!

The declaration of conformity in its original version is delivered together with the equipment.

2.4 - WARRANTY

PIETRO FIORENTINI S.P.A. guarantees that the equipment was manufactured using the best materials, with high quality workmanship, and complies with the quality requirements, specifications and performance set out in the order.

The warranty shall be considered null and void and PIETRO FIORENTINI S.P.A. shall not be liable for any damage and/or malfunctions:

- due to any acts or omissions of the purchaser or end-user, or any of their carriers, employees, agents, or any third party or entity;
- in the event that the purchaser, or a third party, makes changes to the equipment supplied by PIETRO FIORENTINI S.P.A. without the prior written approval of the latter;
- in the event of failure by the purchaser to comply with the instructions contained in this manual, as provided by PIETRO FIORENTINI S.P.A.

NOTICE!

The warranty conditions are specified in the commercial contract.

2.4.1 - REFERENCE OPERATING CONDITIONS

The reference operating conditions to calculate the life span of the batteries are described in the UNI/TS 11291-11-1 and 11291-12-1 standards. An extract of these standards is found in Tab. 2.4:

Operative condition	Reference indications
User interface	10 minutes per month (local interface).
	20 minutes per month (Display).
Shut-off valve (optional)	2 handling cycles (opening/closing) every year.
Upgrade firmware code	Twice in 15 years.
Communication	GPRS Version: <ul style="list-style-type: none"> • 1 communication per day (recording = 30 sec., communication = 20 sec.).
	Version NBloT: <ul style="list-style-type: none"> • 1 recording per year; • 1 communication per day.
	Version RF169: <ul style="list-style-type: none"> • 4 transmissions per day (Tx Totaliser value); • 1 communication per day (Tx/Rx).

Tab. 2.4.

In addition to that defined by the UNI/TS 11291-11-1 and 11291-12-1 standards, the room temperature effects the life span of the batteries. The operating profile used to calculate the battery life expectancy is indicated in Tab. 2.5:

	Reference indications
Ambient temperature	0.25% of the time at -25 °C
	0.5% of the time at -20 °C
	2.6% of the time at -10 °C
	41.0% of the time at +5 °C
	43.0% of the time at +20 °C
	11.8% of the time at +35 °C
	0.5% of the time at +50 °C
	0.25% of the time at +60 °C
	0.1% of the time at +70 °C

Tab. 2.5.

2.5 - ADDRESSEES, SUPPLY AND STORAGE OF THE MANUAL

The manual is intended for the qualified technician responsible for operating and managing the equipment throughout its service life.

It contains the necessary information for the correct use of the equipment in order to maintain its functional and qualitative characteristics over time. All information and warnings for correct use in full safety are also provided.

The manual, as well as the declaration of conformity and/or test certificate, is an integral part of the equipment and must always accompany it whenever it is moved or resold. It is the responsibility of the qualified professionals (see paragraph 2.10) to use and manage the equipment.

WARNING!

Removing, rewriting or modifying the pages of the manual and their contents is not allowed.

PIETRO FIORENTINI S.p.A. shall not be held liable for any damage to people, animals and property caused by failure to adhere to the warnings and operating procedures described in this manual.

2.6 - LANGUAGE

The original manual has been drawn up in Italian.

Any translations into additional languages must be made from the original manual.

HAZARD!

The translations into other languages cannot be fully verified. If any inconsistency is found, please refer to the text of the original manual.



If inconsistencies are found or the text does not make sense:

- **stop any actions;**
- **immediately contact PIETRO FIORENTINI S.p.A. at the addresses specified in paragraph 2.1 (“Identification of the manufacturer”).**

WARNING!

PIETRO FIORENTINI S.p.A. shall be held liable for the information provided in the original manual only.

2.7 - SYMBOLS USED IN THE MANUAL

Symbol	Definition
	Symbol used to identify important warnings for the safety of the operator and/or equipment.
	Symbol used to identify information of particular importance in the manual. The information may also concern the safety of the personnel involved in using the equipment.
	Obligation to consult the instruction manual/booklet. Refers to a requirement for personnel to refer to (and understand) the operating and warning instructions of the machine before working with or on it.

Tab. 2.6.

HAZARD!

Alerts to a hazard with a high level of risk, an imminent hazardous situation which, if not prevented, will result in death or severe damage.

WARNING!

Alerts to a hazard with a medium level of risk, a potentially hazardous situation which, if not prevented, may result in death or severe damage.

ATTENTION!

Alerts to a hazard with a low level of risk, a potentially hazardous situation which, if not prevented, could result in minor or moderate damage.

NOTICE!







Alerts to specific warnings, directions or notes of particular concern, that are not related to physical injury, as well as practices for which physical injury is not likely to occur.

2.8 - NAMEPLATES APPLIED

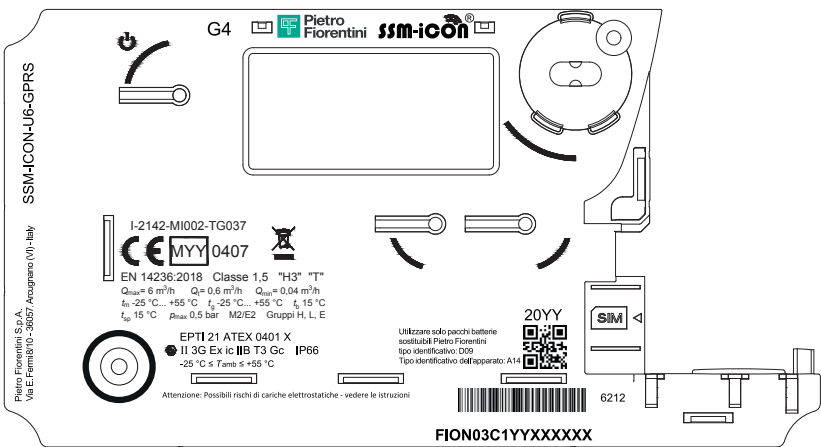
The equipment and its accessories are provided with nameplates (from Id.1 to Id.3).

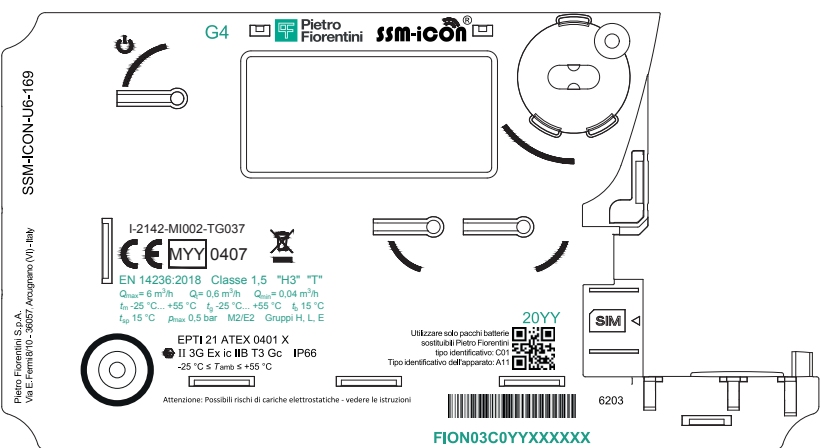
The plates specify identification details of the equipment and its accessories to be mentioned in case of need to PIETRO FIORENTINI S.p.A.

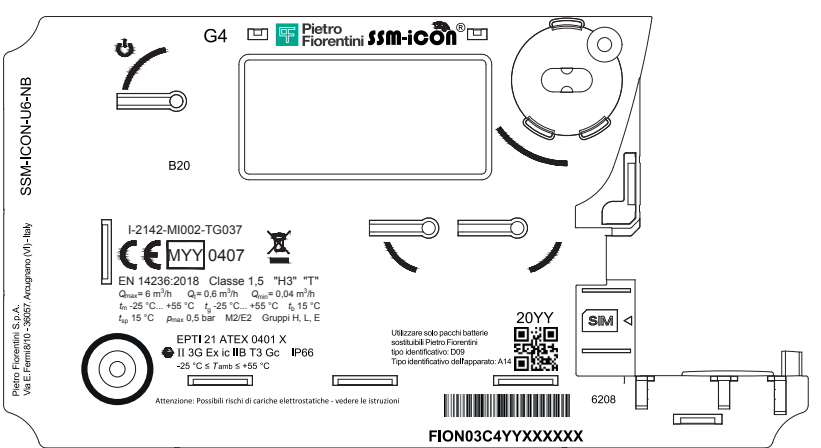
List of the nameplates applied:

Id.	Type of plate	Image
1	Mod. SSM-ICON-U6-GPRS	 <p>SSM-ICON-U6-GPRS</p> <p>Pietro Fiorentini S.p.A. Via E. Fermi 810 - 38067 Anagnino (VI) - Italy</p> <p>G4  ssm-ic[®]on</p> <p>I-2142-MI002-TG037 CE MYY 0407</p> <p>EN 14236:2018 Classe 1.5 "H3" "T" $Q_{max} = 6 \text{ m}^3/\text{h}$ $Q_e = 0.6 \text{ m}^3/\text{h}$ $Q_{min} = 0.04 \text{ m}^3/\text{h}$ $t_{-25} \text{ } ^\circ\text{C} \dots +55 \text{ } ^\circ\text{C}$ $t_{-25} \text{ } ^\circ\text{C} \dots +55 \text{ } ^\circ\text{C}$ $t_{15} \text{ } ^\circ\text{C}$ $t_{sp} 15 \text{ } ^\circ\text{C}$ $p_{max} 0.5 \text{ bar}$ M2/E2 Gruppi H, L, E</p> <p>EPT1 21 ATEX 0401 X II 3G Ex ic IIB T3 Gc IP66 $-25 \text{ } ^\circ\text{C} \leq T_{amb} \leq +55 \text{ } ^\circ\text{C}$</p> <p>Attenzione: Possibili rischi di cariche elettrostatiche - vedere le istruzioni</p> <p>Utilizzare solo pacchi batterie sostituibili Pietro Fiorentini tipo identificativo: D09 Tipo identificativo dell'apparato: A14</p> <p>20YY  SIM</p> <p>6212</p> <p>FION03C1YYXXXXXX</p>
2	Mod. SSM-ICON-U6-169	 <p>SSM-ICON-U6-169</p> <p>Pietro Fiorentini S.p.A. Via E. Fermi 810 - 38067 Anagnino (VI) - Italy</p> <p>G4  ssm-ic[®]on</p> <p>I-2142-MI002-TG037 CE MYY 0407</p> <p>EN 14236:2018 Classe 1.5 "H3" "T" $Q_{max} = 6 \text{ m}^3/\text{h}$ $Q_e = 0.6 \text{ m}^3/\text{h}$ $Q_{min} = 0.04 \text{ m}^3/\text{h}$ $t_{-25} \text{ } ^\circ\text{C} \dots +55 \text{ } ^\circ\text{C}$ $t_{-25} \text{ } ^\circ\text{C} \dots +55 \text{ } ^\circ\text{C}$ $t_{15} \text{ } ^\circ\text{C}$ $t_{sp} 15 \text{ } ^\circ\text{C}$ $p_{max} 0.5 \text{ bar}$ M2/E2 Gruppi H, L, E</p> <p>EPT1 21 ATEX 0401 X II 3G Ex ic IIB T3 Gc IP66 $-25 \text{ } ^\circ\text{C} \leq T_{amb} \leq +55 \text{ } ^\circ\text{C}$</p> <p>Attenzione: Possibili rischi di cariche elettrostatiche - vedere le istruzioni</p> <p>Utilizzare solo pacchi batterie sostituibili Pietro Fiorentini tipo identificativo: C01 Tipo identificativo dell'apparato: A11</p> <p>20YY  SIM</p> <p>6203</p> <p>FION03C0YYXXXXXX</p>
3	Mod. SSM-ICON-U6-NB	 <p>SSM-ICON-U6-NB</p> <p>Pietro Fiorentini S.p.A. Via E. Fermi 810 - 38067 Anagnino (VI) - Italy</p> <p>G4  ssm-ic[®]on</p> <p>B20</p> <p>I-2142-MI002-TG037 CE MYY 0407</p> <p>EN 14236:2018 Classe 1.5 "H3" "T" $Q_{max} = 6 \text{ m}^3/\text{h}$ $Q_e = 0.6 \text{ m}^3/\text{h}$ $Q_{min} = 0.04 \text{ m}^3/\text{h}$ $t_{-25} \text{ } ^\circ\text{C} \dots +55 \text{ } ^\circ\text{C}$ $t_{-25} \text{ } ^\circ\text{C} \dots +55 \text{ } ^\circ\text{C}$ $t_{15} \text{ } ^\circ\text{C}$ $t_{sp} 15 \text{ } ^\circ\text{C}$ $p_{max} 0.5 \text{ bar}$ M2/E2 Gruppi H, L, E</p> <p>EPT1 21 ATEX 0401 X II 3G Ex ic IIB T3 Gc IP66 $-25 \text{ } ^\circ\text{C} \leq T_{amb} \leq +55 \text{ } ^\circ\text{C}$</p> <p>Attenzione: Possibili rischi di cariche elettrostatiche - vedere le istruzioni</p> <p>Utilizzare solo pacchi batterie sostituibili Pietro Fiorentini tipo identificativo: D09 Tipo identificativo dell'apparato: A14</p> <p>20YY  SIM</p> <p>6208</p> <p>FION03C4YYXXXXXX</p>

Tab. 2.7.

WARNING!

Removing nameplates and/or replacing them with other plates is strictly prohibited. Should the plates be unintentionally damaged or removed, the customer must notify PIETRO FIORENTINI S.p.A.

2.8.1 - IDENTIFIER OF THE LOGIC DEVICE

Term	Description
Format	FIO-N-03-WV-YY-XXXXXX
FIO	Fixed field indicating the manufacturer (PIETRO FIORENTINI S.p.A.) according to the encoding of the Flag Association
N	Reserved field
03	Type of device (03=Gas Meter)
W	Type of gauge
V	Remote communication type
YY	Year of manufacture
XXXXXX	Progressive number

Tab. 2.8.

2.8.1.1 - TYPE OF GAUGE

Code "W" version	Gauge value	Model code
C	G4	SSM-ICON-U6

Tab. 2.9.

2.8.1.2 - REMOTE COMMUNICATION TYPE

Code "V" version	Type of communication	Model code
0	RF 169 MHz	SSM-ICON-U6-169
1	GPRS	SSM-ICON-U6-GPRS
4	NB-IoT	SSM-ICON-U6-NB

Tab. 2.10.

2.8.2 - DESCRIPTION OF THE NAMEPLATES

The following information, described in Tab.2.11, is shown on the nameplate:

Pos.	Description
1	Manufacturer's Logo.
2	Static smart meter series.
3	Communication battery pack identification code and device identification type.
4a	Identifier of the logic device (QR code).
4b	Identifier of the logic device.
4c	Identifier of the logic device (barcode).
5	Casing protection rating.
6	"ATEX" Directive marking.
7	Reference standard for "Domestic ultrasonic gas meters", Manufacturer's calibrations, approval levels.
8	Manufacturer's Address.
9	Model code.
10	"MID" Directive marking.
11	Meter reference class.
12	Disposal guidelines (WEEE Directive 2012/19/EU).

Tab. 2.11.

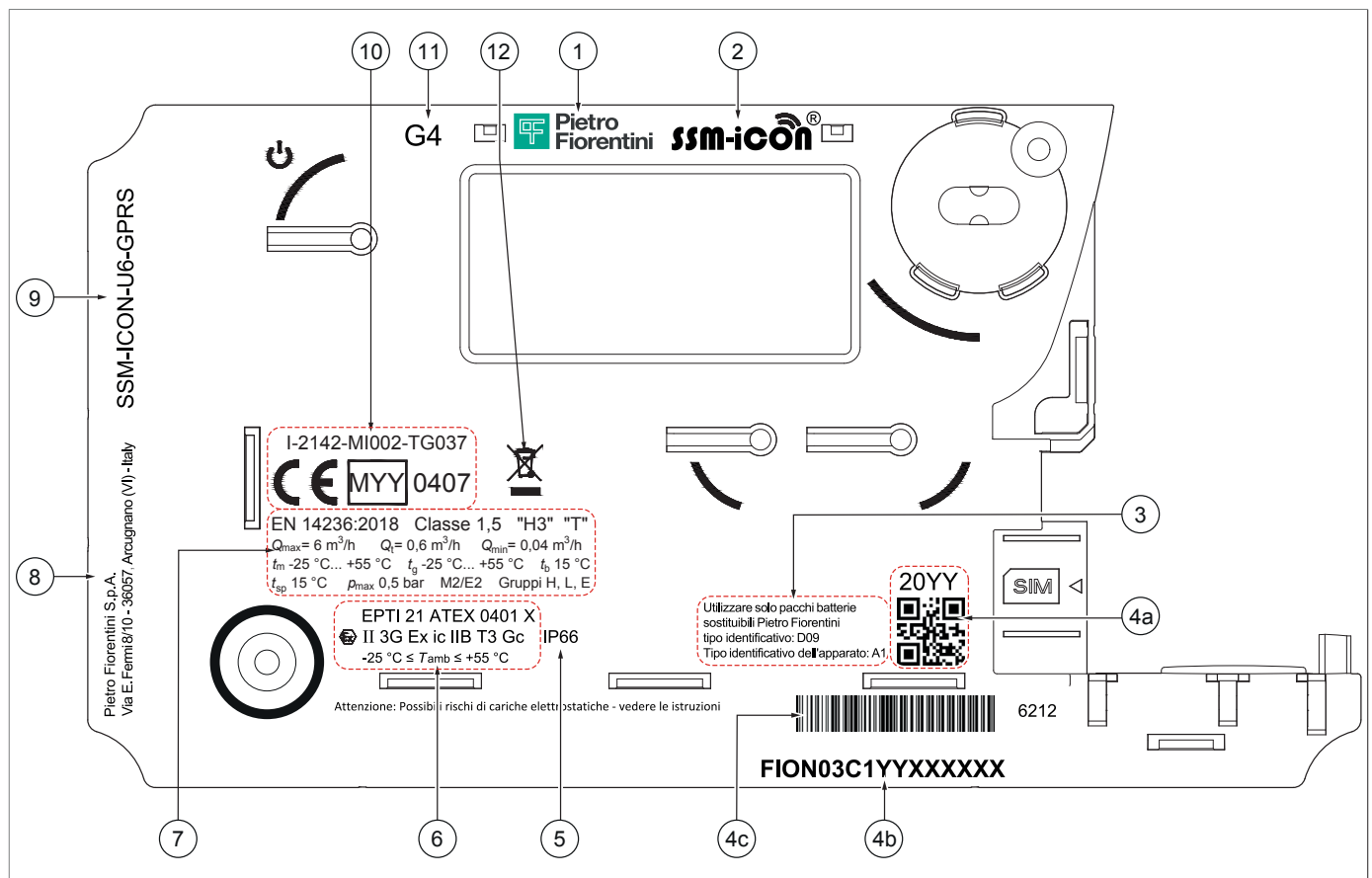

Fig. 2.1. Description of the nameplates

2.9 - GLOSSARY OF MEASUREMENT UNITS

Type of measurement	Unit of measurement	Description
Consumption and Volumetric flow rate	Sm^3/h	Standard cubic metres per hour
	Sm^3	Standard cubic metres
	m^3/h	Cubic metres per hour
	m^3	Cubic metres
Pressure	bar	Bar
	"wc	Water column inch
	Pa	Pascal
Temperature	$^{\circ}\text{C}$	Degree centigrade
	K	Kelvin
Tightening torque	Nm	Newton metro
Other measures	V	Volt
	W	Watt
	Ω	Ohm

Tab. 2.12.

2.10 - QUALIFIED PROFESSIONAL FIGURES

Qualified operators in charge of using and managing the equipment throughout its technical service life to be used as indicated:

Professional figure	Definition
Installer	<p>Qualified operator able to:</p> <ul style="list-style-type: none"> • handle materials and equipment. • carry out all the operations necessary to properly install the equipment; • perform all the operations necessary to safely operate the equipment and system; • be able to perform all the operations necessary to uninstall and subsequently dispose of the equipment in compliance with the regulations in force in the country of installation.
Specialised technician/ Maintenance technician	<p>Trained and authorised technician on the management and use of the equipment, who must:</p> <ul style="list-style-type: none"> • be able to perform all operations required for the proper functioning of the equipment and the system, and for their safety and that of any third parties present; • perform maintenance on all parts of the equipment subject to maintenance (board and batteries); • access all device parts for visual inspection, checking equipment status, making adjustments and calibrations; • have proven experience in properly using the equipment similar to that described in this manual, and be trained, informed and instructed in this regard.

Tab. 2.13.

3 - SAFETY

3.1 - GENERAL SAFETY WARNINGS

WARNING!

The equipment described in this manual is normally installed in systems which transport flammable gases (for example natural gas).

WARNING!

If the gas used is a combustible gas, the installation area of the equipment is defined as a “danger zone” as there are residual risks that potentially explosive atmospheres may be generated.

In “danger zones” and in close proximity thereto:

- there must not be any effective sources of ignition;
- no smoking.

WARNING!

- It is strictly forbidden to repair or make any modifications to the equipment.
- For information and warnings regarding replacing batteries, refer to chapter 9 in this manual.

ATTENTION!

Authorised operators must not carry out operations or services on their own initiative that do not fall within their competence.

Never operate the equipment:

- while under the influence of intoxicating substances such as alcohol;
- if you are using drugs that may slow reaction times.

NOTICE!

The employer must train and inform operators on how to behave during operations and on the equipment to be used.

Before installation, commissioning or maintenance, operators must:

- take note of the safety regulations applicable to the place of installation that they are working in;
- obtain the necessary permits to operate when required;
- equip themselves with the necessary personal protection required in the procedures described in this manual;
- ensure that the area that they are operating in is equipped with the required collective protections and the necessary safety information.

3.2 - ATEX DIRECTIVE SAFETY INSTRUCTIONS

SSM-ICON is an intrinsically safe device suitable for use in hazardous areas classified as Zone 2 Group IIB.

Category of installation: II 3G Ex ic IIB T3 Gc.

The harmonised CENELEC standards relevant to compliance with the EHSR requirements (Essential Health and Safety Requirements) of the ATEX Directive are EN 60079-0 and EN 60079-11.

3.2.1 - ELECTROSTATIC DISCHARGES

This device is approved for installation in areas with low explosion risk (risk is only present for short periods). In these areas, sparks produced by electrostatic discharges might still generate explosions in extreme cases.

WARNING!

During installation or use of this device, it is appropriate to take steps to assure protection against electrostatic discharges.

Further information can be found in EN60079-32-1: among the possible actions, an example is using dissipative footwear and a damp cloth (>65%) during installation/maintenance operations.

NOTICE!

PIETRO FIORENTINI S.p.A. disclaims any liability resulting from the risks and consequences caused by non-compliance with these provisions.

3.2.2 - CONNECTING TO OTHER DEVICES

There is no SSM-ICON connection with external devices.

SSM-ICON can connect locally, using the optical port, to devices for the communication of data and commands useful for device configuration and maintenance.

SSM-ICON can connect using the integrated radio interface (Mbus wireless, or GPRS modem, or NB-IoT type), to remote systems for data communication and management of commands useful for the configuration and maintenance of the device.

3.2.3 - POWER SUPPLY DEVICES

SSM-ICON can only be powered by the specific battery packs approved with the device; using other power sources is prohibited.

The device uses two distinct battery packs:

- one that is useful for managing the metrological part and local interfaces called the metrological battery pack, which cannot be replaced in the field;
- one that is useful for managing the remote communication part called communication battery pack, which can be replaced in the field.

Each pack consists of a lithium battery with cables ending with a specific connector, enclosed in a protective sheath.

3.2.4 - SAFETY INSTRUCTIONS FOR INSTALLATION IN HAZARDOUS AREA

This device must be installed and operated in compliance with the provisions and regulations in force.

NOTICE!

PIETRO FIORENTINI S.p.A. shall not be liable for damage resulting from failure to comply with the instructions and from misuse.

Safety warnings

All operations on the device must be performed by qualified personnel.

Transformation and spare parts

Any technical changes are forbidden. Use only original spare parts intended by PIETRO FIORENTINI S.p.A.

Transport

As a rule, SSM-ICON must be transported in an upright position and inside the original packaging box provided by PIETRO FIORENTINI S.p.A.

Upon receipt of the device, examine the supplied material.

Immediately report any shipping damage.

Storage

As a rule, SSM-ICON must be stored in an upright position and in a dry place at room temperature (refer to paragraph 6.6.1).

WARNING!

- **The arrow on the top of the device indicates the direction of the gas flow.**
- **Install the device in a compartment that meets the provisions in force on safety, away from any possible damage of mechanical origin, away from sources of heat or naked flames, in a dry place and protected from external agents.**
- **Install the device with the indicator device in a horizontal position, not in contact with walls and raised from the floor.**
- **During installation, avoid mechanical stress to the inlet and outlet connections.**
- **The optional shut-off valve, located in the system upstream of the device, must be opened in a gradual manner in order to allow the gas to flow evenly, without violent shocks that would damage the internal components.**
- **It is strictly forbidden to repair or make any modifications to the device.**
- **The installation, removal, and any operations must be performed by qualified personnel, in compliance with the provisions in force concerning safety.**

3.3 - PERSONAL PROTECTIVE EQUIPMENT

The following table shows the Personal Protective Equipment (PPE) and its description; an obligation is associated with each symbol.

Personal protective equipment means any equipment intended to be worn by the worker in order to protect them against one or more risks that are likely to threaten their safety or health during work.

For the operators in charge, depending on the type of work requested, the most appropriate PPE from those reported in Tab.3.14 must be used:

Symbol	Meaning
	Obligation to use safety or insulated gloves. Indicates a requirement for personnel to use safety or insulated gloves.
	Obligation to use safety goggles. Indicates a requirement for personnel to use protective goggles for eye protection.
	Obligation to use safety shoes. Indicates a requirement for personnel to use accident-prevention safety shoes.
	Obligation to use noise protection equipment. Indicates a requirement for personnel to use ear muffs or ear plugs to protect their hearing.
	Obligation to wear protective clothing. Indicates a requirement for personnel to wear specific protective clothing.
	Obligation to use a protective mask. Indicates a requirement for personnel to use respiratory masks in the event of a chemical risk.
	Obligation to use a protective helmet. Indicates a requirement for personnel to use the protective helmet.
	Obligation to wear a high visibility vest. Indicates a requirement for personnel to use a high visibility vest.

Tab. 3.14.

WARNING!

Each licensed operator is obliged to:

- take care of their own health and safety and that of other people present in the workplace, who are affected by their actions or omissions, in accordance with their training, instructions and means provided by the employer;
- use the PPE appropriately made available;
- immediately report to the employer, the manager or the person in charge of the deficiencies of the means and devices as well as any possible dangerous conditions of which they become aware.

3.4 - OBLIGATIONS AND PROHIBITIONS

The following is a list of obligations and prohibitions to be observed for the safety of the operator:

It is mandatory to:

- carefully read and understand the use, maintenance and warning manual;
- before installing the equipment, strictly refer to the details specified on the nameplates and in the manual;
- avoid knocks and violent impacts that could damage the equipment.

It is forbidden to:

- operate in various capacities on the equipment without the PPE indicated in the work procedures described in this manual;
- operate in the presence of open flames or bring open flames close to the work area;
- smoke near the equipment or while working on it;
- use the equipment with parameters other than those indicated on the nameplate;
- use the equipment with gas units other than those indicated on the meter nameplate;
- use the equipment outside the operating temperature range declared on the identification plate and indicated in this manual;
- install or use the equipment in environments other than those specified in this manual.

3.5 - RESIDUAL RISKS

The equipment does not present residual risks for the operator related to its normal operation.

NOTICE!

The equipment is ATEX Zone 2 Category 3G certified.

During normal activities, it is unlikely for an explosive atmosphere to form in this zone, consisting of a mixture of air and flammable substances in the form of gas, steam or mist and if it occurs, it only lasts a short time (from 0.1h to 10h/365 days).

WARNING!

If there are any functional faults, do not operate.

Immediately contact PIETRO FIORENTINI S.p.A. for the necessary directions.

3.5.1 - RISK OF ELECTROSTATIC DISCHARGE

This device is approved for installation in areas with low explosion risk (risk is only present for short periods).

Due to the gas in the atmosphere, sparks produced in these areas by electrostatic discharges might still generate explosions in extreme cases.

WARNING!

It is mandatory to implement protective measures against electrostatic discharges during installation, configuration and maintenance of the equipment.

The authorised operator must proceed as follows, during the various operational phases, to avoid the risk:

Operational phases	Obligations of the operator
Installation	<ul style="list-style-type: none"> Wear professional safety footwear with ESD characteristics; Wear work clothes that dissipate electrostatic charges; Use a damp cloth for cleaning.
Configuration	<ul style="list-style-type: none"> Wear professional safety footwear with ESD characteristics; Wear work clothes that dissipate electrostatic charges.
Maintenance	<ul style="list-style-type: none"> Wear professional safety footwear with ESD characteristics; Wear work clothes that dissipate electrostatic charges; Use a damp cloth for cleaning.

Tab. 3.15.

3.6 - SAFETY AND FRAUD PREVENTION

The solutions implemented on the equipment to assure safety comply with the requirements set forth by the reference standard in force (UNI/TS 11291). In detail, access:

- to the electronics is not possible without removing the mechanical metrological seals and without causing permanent damage to the metrological cover, in accordance with that described in the legalisation plan indicated in the type examination certificate (MID) of the meter;
- to the memory device is not possible without permanently and patently damaging the equipment;
- to the flow shut-off valve (optional) and the temperature sensor is not possible without permanently and patently damaging the equipment;
- to the metrological battery pack (not replaceable) is not possible without removing the mechanical and metrological seal and without permanently damaging the metrological cover;
- to the communication battery pack (replaceable) is not possible without compromising the screw cover seals and without leaving a trace of the event in the relevant memory register (Metrological Events Log) of the equipment.

The attempts:

- to tamper with proper operation of the meter are detected and recorded in the Metrological Events Log;
- by unauthorised personnel to access the meter through the communication channels which it is equipped with are detected and recorded in the Metrological Events Log;
- to access the meter through the communication channels made with wrong passwords or encryption keys are detected, listed and made available to the control centre.

NOTICE!





- **The interface equipment usually available to the user can only be used to read the data and it is not possible to perform any configuration;**
- **The configurations that can be performed through the communication channels which the device is equipped with – which can only be carried out by authorised personnel – leave a track since they are stored in the appropriate memory log (Metrological Events Log).**

Furthermore:

- the commands sent by external devices through the communication channels which the device is equipped with are verified in terms of source authenticity;
- the messages transmitted through the communication channels conveying sensitive information are all efficiently encrypted;
- the duration of the conditions is monitored and recorded by the firmware.

3.7 - SAFETY PICTOGRAMS

The safety pictograms described in Tab.3.16 may be shown on the equipment and/or packaging PIETRO FIORENTINI S.p.A.:

Symbol	Definition
	Symbol used to identify a GENERIC HAZARD.
	Symbol used to identify DANGERS GENERATED BY STATIC ELECTRICITY.
	Symbol applied to the packaging to identify the type of danger and risks related to the transported product, based on the classification of the European ADR agreement. Class 9 (Various dangerous substances). ADR - UN3090 (lithium metal batteries).
	The symbol indicates that the product must not be disposed of as unsorted waste but must be sent to separate collection facilities for recovery and recycling (WEEE Directive 2012/19/EU on waste electrical and electronic equipment - WEEE)

Tab. 3.16.

WARNING!

It is absolutely forbidden to remove or alter the safety pictograms on the equipment or the packaging.

3.8 - RISK LEVEL

SSM-ICON is a static meter and has no moving parts.

For the value of the noise generated by the equipment and further information, contact PIETRO FIORENTINI S.p.A.

ATTENTION!

The obligation to use earmuffs or ear plugs to protect the hearing of qualified professional figures (reference paragraph 2.10) remains in the event that the noise in the installation environment of the equipment (depending on specific operating conditions) exceeds the value of 85 dBA.

4 - DESCRIPTION AND OPERATION

4.1 - GENERAL DESCRIPTION

The equipment SSM-ICON is a static gas flow meter, which is applied in the end redelivery points of the gas networks. The meter integrates a static sensor to measure the volume that can:

- guarantee the consumption detection functions;
- transmit the data as prescribed by current applicable legislation.

SSM-ICON is a measuring device:

- with accuracy class 1.5, as defined in Directive 2014/32/EU (MID);
- which can carry out consumption profiling as required by the Regulatory Authority for Energy, Networks and Environment (ARERA) in resolution 631/2013/R/gas and ratified in the UNI/TS 11291 package of standards.

The main elements of the equipment are (see Fig. 4.2.):

Pos.	Description	Pos.	Description
1	Metrological cover	5	Inlet pipe connection fitting
2	Plastic enclosure	6	Outlet pipe connection fitting
3	LCD display	-	Metrological battery *
4	Battery compartment (communication)	-	Shut-off valve (optional) *

* Detail not visible in figure

Tab. 4.17.

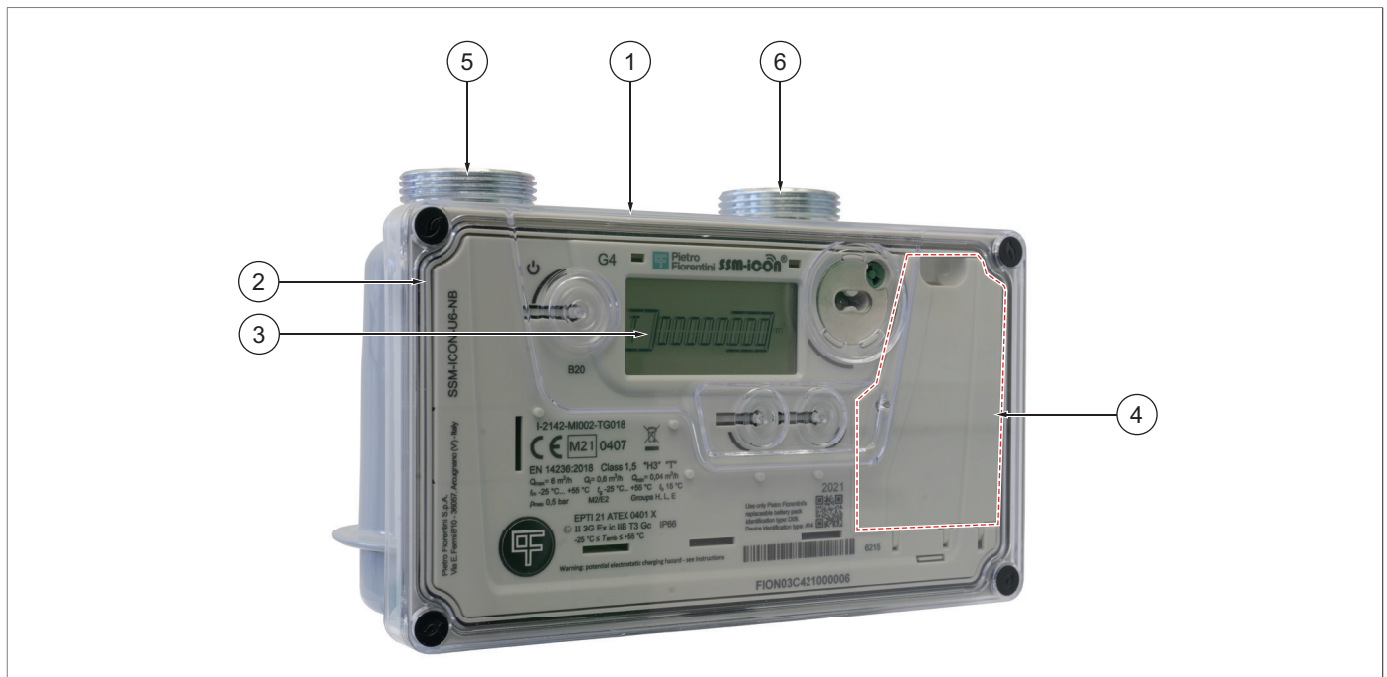

Fig. 4.2. General description SSM-ICON

4.1.1 - POWER SUPPLY DEVICES

The equipment SSM-ICON can only be powered by the specific approved battery packs.

The device uses two distinct battery packs:

- the metrological battery which cannot be replaced in the field, useful for managing the metrological part and local interfaces;
- the communication battery, which can be replaced in the field, useful for managing the remote communication.

Each pack consists of a lithium battery with cables ending with a specific connector, enclosed in a protective sheath.

NOTICE!

For the technical details of the battery packs and the reference operating conditions, refer to paragraph 4.3 “Technical data”.

4.1.1.1 - CONNECTION OF THE POWER SUPPLY DEVICES

NOTICE!

The equipment SSM-ICON is supplied with both battery packs already connected and ready for use in the field.

4.1.1.2 - POWER SUPPLY STATUS

A calculation is made for every battery pack, of the actual consumption, based on:

- the elapsed time;
- the individual functions actually performed (e.g.: switching on the display, pressing buttons, local and remote data transmission, etc);
- the weight in terms of consumption defined for every specific function in the laboratory tests carried out by the Manufacturer;
- 10% remaining charge being reached, an alarm is recorded and shown on the display.

4.1.2 - SHUT-OFF VALVE (OPTIONAL)

The gas flow shut-off valve is found inside the body of the meter in the outlet fitting, which intercepts the gas flow to the utility for commercial purposes only.

The valve is specifically designed to guarantee its performance and operation for at least 20 years.

WARNING!

In no way or condition must the valve be considered and used as a device to assure safety conditions in the user's system in case of possible or patent gas leaks.

The valve can provide:

- the actual state of the supply (closed/open valve) to the control microprocessor;
- indications on correct operation.

The valve can be closed:

- via the remote communication channel (e.g.: command sent from the Remote management centre or the CAS – Central Acquisition System);
- when the change of the communication battery pack is not authorised;
- for break-in attempts above the threshold (configurable as described in the UNI/TS 11291-11 and 11291-12 standards);
- when the authorised battery change lasts too long (configurable time threshold);
- in case of no remote communication longer than a configurable time;
- if the residual charge of the metrological battery pack is below the critical level (1%);
- if the equipment management system malfunctions.

The valve is controlled by the meter by checking:

- the physical state ("**Open**" and "**Closed**" values);
- the logic state ("**Re-enabled on opening**" with the physical state at the "**Closed**" valve value).

NOTICE!

Refer to Chapter 5 "User Interface" for the valve opening procedure.

4.1.3 - ACQUISITION OF THE MEASURE

The flow of gas volumes (flow rate) is measured continuously with a specific sensor, connected to the calculation board with an electrical connection.

The governing microprocessor:

- pilots the detection of the flow rate and temperature sensors;
- carries out continuous diagnostic activity to highlight any failures and fraud attempts.

The temperature measurement, required to calculate the volumes at the thermodynamic conditions of reference, is carried out via a temperature sensor, which provides a measurement in Kelvin (with a resolution of 0.0625 K).

4.1.4 - EVENTS AND DIAGNOSTICS

With reference to the standards of the UNI/TS 11291 series, the equipment implements in particular the following services:

- detection and reporting of faults (UNI/TS 11291-1);
- functional requirements - events log (UNI/TS 11291-6);
- functional requirements - diagnostics and alarms (UNI/TS 11291-6).

4.1.5 - ACTIVATION AND CONFIGURATION

With reference to the standards of the UNI/TS 11291 series, the equipment implements in particular the following services:

- synchronisation (UNI/TS 11291-1);
- software upgrade (UNI/TS 11291-1);
- control and maintenance of the infrastructure (UNI/TS 11291-1);
- functional requirements - programming (UNI/TS 11291-6);
- functional requirements – operations concerning commissioning and maintenance (UNI/TS 11291-6);
- functional requirements - clock (UNI/TS 11291-6).

4.1.6 - COMMUNICATION INTERFACES

The equipment has two communication interfaces, a local one and a remote one:

Interface	Type	Description
Local	Optical port/infrared	Requires an external device (optical probe) for connection to a local terminal/PC (compliant with IEC 62056-21). The physical protocol used for the optical port is of HDLC type. The asynchronous format and the speed of the optical port are set to the following values: <ul style="list-style-type: none"> • speed: 9600 baud; • data format: 8 (start bit), 1 (data bit), N (no parity), 1 (stop bit). The optical port is normally disabled and is activated when the display is switched on.
Remote	Mod. SSM-ICON-U6-GPRS	Modem GPRS quad-band and antenna integrated in the device.
	Mod. SSM-ICON-U6-NB	Modem NB-IoT multi-band and antenna integrated in the device.
	Mod. SSM-ICON-U6-169	Modem Wireless MBus and antenna integrated in the device.

Tab. 4.18.

4.1.7 - USER INTERFACE

NOTICE!

Refer to chapter 5 in this manual for all information on the user interface.

4.2 - INTENDED USE

4.2.1 - ENVISAGED USE

The equipment in question is intended for:

Operation	Permitted	Unpermitted	Work environment
Measuring the volume of gas	2 nd family gas, H, L and E (UNI EN 437).	Any other type of gas other than permitted.	Application in end redelivery points of the gas networks used: <ul style="list-style-type: none"> residential; commercial.

Tab. 4.19.

The equipment referred to was designed to be used exclusively within the limits specified on the nameplate and according to the instructions and limits of use specified in this manual.

Safe work parameters are:

- use within the limits stated on the nameplate and in this manual;
- compliance with the user manual procedures;
- routine maintenance to be carried out when and how recommended;
- special maintenance to be carried out if required;
- do not tamper with and/or bypass the safety devices.

4.2.2 - REASONABLY FORESEEABLE MISUSE

Incorrect and reasonably foreseeable misuse means the use of the equipment in a way not foreseen in the phase but which can result from result predictable human behaviour:

- using the equipment in a manner other than that referred to under “**Intended use**”.
- instinctive reaction of an operator in the event of a malfunction, accident or breakdown while using the equipment;
- behaviour resulting from carelessness;
- behaviour resulting from the use of the equipment by unauthorised and unsuitable people (children, disabled);

Any use of the equipment other than the intended use must be previously approved in writing by PIETRO FIORENTINI S.p.A. If no written approval is provided, use shall be considered “**improper**”.

In the event of “improper use”, PIETRO FIORENTINI S.p.A. shall not be held liable for any damage caused to people or property, and any type of warranty on the equipment shall be deemed void.

4.3 - TECHNICAL DATA

General features	
Electronic casing	Polycarbonate
Casing protection rating	IP55 (IP66 on request)
Maximum working pressure	0.5 bar
Operative temperature range	from -25 °C to +55 °C
Gas temperature range	from -25 °C to +55 °C
Temperature sensor	Integrated
Real time clock	Accuracy according to EN62054-21
Measurement precision	Class 1.5
ATEX marking	II 3G Ex ic IIB T3 Gc
Tubing connections	1" 1/4 ISO 228

Tab. 4.20.

Remote communication features	
Communication band	<ul style="list-style-type: none"> SSM-ICON-U6-GPRS: Quad-band; SSM-ICON-U6-NB: Band 20 (default), 3, 5, 8, 25, 28; SSM-ICON-U6-169: Wireless M-Bus 169MHz (Mode N2).

Tab. 4.21.

Battery features	
Metrological battery pack	Type: Non-rechargeable battery Li-SOCl ₂ 3,6V, Size C - D Autonomy: Size C >15 years Size D > 20 years ("Extended Life" version models)
Communication battery pack SSM-ICON-U6-GPRS*	Identifier type: D09** Type: Non-rechargeable battery Li-SOCl ₂ 3,6V, Size D Autonomy: > 8 years
Communication battery pack SSM-ICON-U6-NB*	Identifier type: D09** Type: Non-rechargeable battery Li-SOCl ₂ 3,6V, Size D Autonomy: > 20 years
Communication battery pack SSM-ICON-U6-169*	Identifier type: C01** Type: Non-rechargeable battery Li-SOCl ₂ 3,6V, Size C Autonomy: > 20 years

* Replaceable in the field

** The "identifier type" of the battery pack must be specified when ordering new parts to be replaced in the field.

Tab. 4.22.

5 - USER INTERFACE

5.1 - GENERAL DESCRIPTION

The following paragraphs describe the interaction methods between operator and user interface, and the meanings of the various fields on the display.

The user interface consists of the following main components, through which it is possible to consult the data provided by the device (see Fig.5.3.):

Pos.	Element	Description
1	Black and white LCD display with segments	Allows you to consult the data provided by the equipment.
2	“On/Enter” key	Allows you to turn on the equipment and confirm the settings from the display.
3	Navigation keys	They allow you to browse through the pages and data menus of the display.

Tab. 5.23.



Fig. 5.3. User interface SSM-ICON

5.2 - LCD DISPLAY DESCRIPTION

! NOTICE!

To assure a long battery life, the display is usually kept off.

With the display off, turn it on by pressing the “Enter” key for at least 1 s.

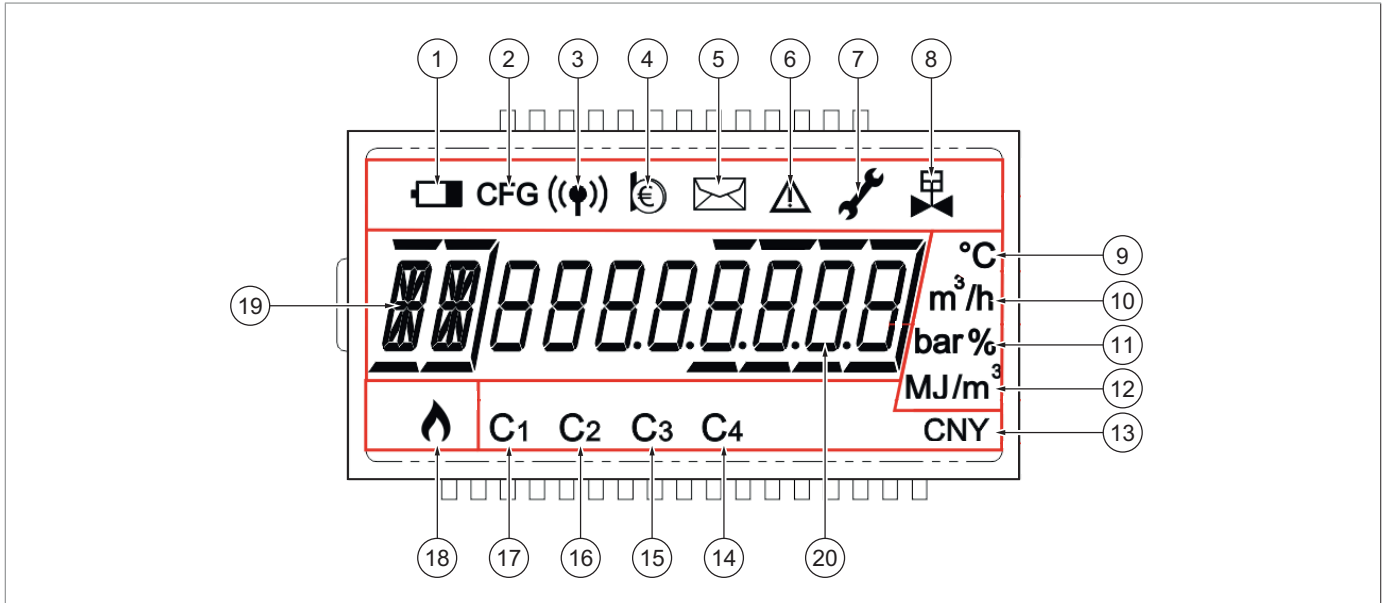



Fig. 5.4. LCD display SSM-ICON

Tab. 5.24. describes the main elements on the display:

Pos.	Element	Description
ICONS FIELD		
1	Battery	If active, it indicates the low charge level (<10%) of at least one of the battery packs.
2	CFG	If active, it indicates that the device has been configured with the minimum operating data (according to UNI/TS 11291-6).
3	Antenna	When active, indicates a remote communication session in progress.
4	Coin	When active, it indicates the prepayment condition.
5	Message	If active, it indicates the presence of a message for the end user.
6	General alarm	When the icon is: <ul style="list-style-type: none"> on and steady, it indicates the presence of an alarm condition. The alarm has been recorded and is currently present; flashing, it indicates the presence of a passed alarm condition. The alarm has been recorded and ended but has not yet been read and recovered by remote communication; off, no current alarm condition.
7	Maintenance state	When visible, it indicates the activation of the maintenance state. Activating the maintenance state prevents alarm conditions from occurring.
8	Valve	If active, it indicates that the valve is closed and the supply interrupted.

Pos.	Element	Description
UNITS OF MEASUREMENT FIELD		
9	°C	Based on the selection, it indicates the measurement unit in which the value shown in the numeric field is expressed (Pos. 20).
 NOTICE! All volume and flow rate values shown on the display as m³ or m³/h are to be understood as volumes or flow rates converted to the basic reference conditions (Sm³ and Sm³/h).		
10	m ³ /h	
11	bar, %	
12	MJ/m ³	<i>not used by SSM-ICON</i>
13	CNY	
ACTIVE CHAPTER FIELD		
14	C4	Indicates the currently active chapter.
15	C3	The first chapter displayed when the display is turned on is called the default chapter. The default chapter does not activate any icon (C1, C2, C3 and C4 off).
16	C2	
 NOTICE! Refer to paragraph 5.3 on how to select and navigate the chapters.		
17	C1	
CONSUMPTION INDICATOR FIELD		
18	Flame	If active, it indicates the presence of a current gas flow.
EXPLANATORY FIELD		
19	Data reference	Encodes the type of parameter displayed
NUMERICAL FIELD		
20	Data	Indicates the value referring to the indicated parameter.

Tab. 5.24.

5.3 - NAVIGATION PROCEDURE

! NOTICE!

- With the display on, the “Enter” key can be pressed in “short” or “long” mode (> 2 s.).
- The navigation keys are always activated in “short” mode.
- Failure to press any key for more than 2 minutes returns the display to the off state.

The information is organised into “chapters” in the interface and each chapter consists of more information organised in “pages” that can be navigated in sequence.

Tab. 5.25. indicates the navigation procedure in the interface:

Step	Action
1	Press “Enter” (at least 1 s.) to turn the display on. ! NOTICE! A “lamp test” is performed upon switch-on, lasting about 2 seconds, during which all fields will be on.
2	At the end of the “lamp test”, the pages of the “Default chapter” are displayed. ! NOTICE! Refer to paragraph 5.3.1 for information on the “Default chapter”.
3	If necessary, press the “ Enter ” button (in “long” mode) from the “default chapter”, to access the chapter selection. ! NOTICE! Refer to paragraph 5.3.2 for information on the “Chapter selection”.
4	If necessary, press the " Enter " button from the "chapter selection" to access the specific sequence of pages of a chapter. Press the “Enter” button in “long” mode to return to the “default chapter” (Step 3).
5	Press the navigation keys to scroll through the information sequence of the chapter selected in Step 4 . Press the “Enter” button in “long” mode to return to the “chapter selection” (Step 4).

Tab. 5.25.

! NOTICE!

Once the last page of a chapter is reached, the navigation sequence grants the ability to resume from the first page of the same chapter.

5.3.1 - DEFAULT CHAPTER (CURRENT RATE PERIOD)

While viewing the following chapter, the symbols shown in the "Active chapter field" will all be off.
Tab. 5.26. indicates the sequence for displaying the pages of the default chapter:

Sequence	Explanatory field	Description
1	T	Vb volume totaliser [Sm ³].
2	TA	Vb volume totaliser in alarm [Sm ³].
3	T1	Vb volume totaliser in range 1 [Sm ³].
4	T2	Vb volume totaliser in range 2 [Sm ³].
5	T3	Vb volume totaliser in range 3 [Sm ³].
6	Dc	Current date: dd-mm-yy format.
7	Hc	Current time: hh-mm-ss format.
8	Fn	Current fee range (default range: F3).

Tab. 5.26.





NOTICE!

By pressing the "Enter" button in "long" mode on any page of the default chapter, the presentation of the "Chapter selection" menu is activated as indicated in paragraph 5.3.2.

5.3.2 - CHAPTER SELECTION

Use the navigation keys to scroll through the chapters on the interface; then press the "Enter" key in "short" mode to access the sequence of specific pages of the chapter visible in the "Active chapter field".

Tab. 5.27. indicates the sequence for the following display during the chapter selection phase:

Sequence	Explanatory field	Numerical field	Active chapter field	Description
1	PC	Pt-C	Default	Allows you to browse through the data of the current billing period.
2	PP	Pt-P	C1	Allows you to browse through the data of the previous billing period.  NOTICE! Consult paragraph 5.3.3.
3	GE	GEn	C2	Allows you to navigate through the general parameters of the equipment.  NOTICE! Consult paragraph 5.3.4.
4	SE	SEr	C3	Allows you to navigate through the service screens of the equipment.  NOTICE! Consult paragraph 5.3.5.
5	CM	169 GPrS Nb-iot	C4	Allows you to navigate through the communication parameters of the equipment.  NOTICE! Consult paragraph 5.3.6.

Tab. 5.27.

5.3.3 - CHAPTER 1 (PREVIOUS BILLING PERIOD)

Tab. 5.28. indicates the explanatory table of the sequence in which the pages of the chapter are displayed:

Sequence	Explanatory field	Description
1	T	Vb volume totaliser [Sm ³].
2	TA	Vb volume totaliser in alarm [Sm ³].
3	T1	Vb volume totaliser in range 1 [Sm ³].
4	T2	Vb volume totaliser in range 2 [Sm ³].
5	T3	Vb volume totaliser in range 3 [Sm ³].
6	Qm	Maximum conventional flow rate in the period [Sm ³ /h].
7	TP	Rate plan.
8	DP	Date when the previous billing period has been closed. <div style="border: 1px solid black; padding: 5px; margin-top: 10px;">  NOTICE! The reason for the closure of the period is also indicated (according to the encoding of the UNI/TS 11291-11-2 and UNI/TS 11291-12-2 standards). </div>

Tab. 5.28.

5.3.4 - CHAPTER 2 (MAIN PARAMETERS)

Tab. 5.29. indicates the explanatory table of the sequence in which the pages of the chapter are displayed:

Sequence	Explanatory field	Numerical field	Description
1	SW	InFo	Sub-menu to access the firmware device pages and the operating status. Press "Enter" in "short" mode to access the sub-menu.
2	SW	HH	Press "Enter" in "short" mode to access the log of the last 32 firmware upgrades.
3	SW	PArAm	Press "Enter" in "short" mode to access the log of the last 128 modified metrological parameters.
4	ME	Message (the messages scroll with the < and > keys once Enter is pressed)	Display of messages present. If there are no messages, "NO MSG" is displayed in the numeric item.
5	ID	PdR (the digits scroll with the < and > keys once Enter is pressed)	Displays the value of the "Redelivery Point" (PdR) field.
6	SV	<ul style="list-style-type: none"> • "VAL 00 A" = valve open; • "VAL 20 C" = valve closed; • "VAL 40 r" = re-enabled valve. 	Valve status. Press "Enter" in "short" mode to access the relative sub-menus.
7	DG	XXXX	Hexadecimal code of the diagnostics bits according to standards: UNI/TS 11291-11-2 and UNI/TS 11291-12-2.
8	Qm	5 digits: 2 integers and 3 decimals (excluding the non-significant zeros)	Maximum conventional flow rate in the current period (m ³ /h).
9	TP	Rate plan	Current rate plan.

Tab. 5.29.

5.3.4.1 - SUB-MENU OF THE FIRMWARE DEVICE AND THE OPERATING STATUS

Explanatory field	Numerical field	Description
SW	ppp xxxx (8 digits in total)	Display page of the parameter with “ppp” prefix whose value is “xxxx”.

Tab. 5.30.

By pressing the "Enter" key, while the "SW InFo" menu is displayed (refer to paragraph 5.3.4, sequence 1), you will access the first submenu of information relating to the device firmware and general operation status.

Press the navigation keys to scroll the parameters in sequence, identified by their own prefix, shown in Tab.5.31.:

Prefix	Description
01L	Metrological Firmware (LR) - CRC16 in hexadecimal.
02L	Metrological Firmware (LR) - Firmware release to be read as nn.ss (e.g. 0104 = 01.04).
03b	Metrological Firmware (LR) -Boot section - CRC16 in hexadecimal.
04b	Metrological Firmware (LR) -Boot section – Firmware release to be read as nn.ss (e.g. 0101 = 01.01).
05n	Non-Metrological Firmware (NLR) - CRC16 in hexadecimal.
06n	Non Metrological Firmware (NLR) - Firmware release to be read as nn.ss (e.g. 0006 = 00.06 = 0.06).
-	Firmware upgrade date (00-00-00 if default version).
-	Firmware upgrade time (00-00-00 if default version).
09	Days of operation.
-	Hours, minutes and seconds (h-m-s) of operation.
11	Days of operation in active status.
-	Hours, minutes and seconds (h-m-s) of operation in active status
13	LR parameters editing events meter.
14	Firmware upgrade events meter.
15	Firmware upgrade not completed successfully events meter.
16	Firmware restart events meter.
17	CRC errors relative to LR data meter.
18	Fraud events meters.

Tab. 5.31.

By pressing the “Enter” key it is possible to return to the previous menu (refer to paragraph 5.3.4).

5.3.5 - CHAPTER 3 (SERVICE)

Tab. 5.32. indicates the explanatory table of the sequence in which the pages of the chapter are displayed:

Sequence	Explanatory field	Numerical field	Description
1	Sd	0, 1, 3	Status of the device. NOTICE! The maintenance and/or configured status is highlighted by the dedicated icon.
2	t	3 digits, 2 integers, 1 decimal (E.g.: 15.0 °C)	Current gas temperature in °C (in °C with 1 decimal place).
3	EV	dd-mm-yy	Date of the first event in the metrological log.
4	Rc	rS	“Count Resolution” menu. NOTICE! By selecting the “H” value (High resolution), the resolution with 4 integers + 4 decimal digits is activated for the totalisers T and TA; following the activation of the "High resolution" mode, the display shows the message "High". If the operator makes no other selection, the resolution goes back automatically to the default value (5 integers + 3 decimals) at 00:00 the next day. Selecting the value “L” (Low resolution), indicates the resolution in the configuration of 5 integers + 3 decimals.
5	Cd	diSPLaY	“Display contrast” menu. NOTICE! On the "diSPLaY" page, a short activation of the "Enter" key activates the relevant sub-menu, with the presentation of the contrast level ("X") corresponding to the brightness of the display in progress. The value of "X" is between 1 and 5 (5 indicates the highest contrast). The brightness can be changed by pressing the navigation keys. You exit the sub-menu and go back to the previous page by pressing the “Enter” key (short press).

Tab. 5.32.

5.3.6 - CHAPTER 4 (COMMUNICATION)

Tab. 5.33., Tab. 5.34. and Tab. 5.35. indicate the sequences for viewing the pages of the chapter, by model:

Models with GPRS type of remote communication

Sequence	Explanatory field	Description
1	TC	Communication Test Page.
2	QC	Current CSQ value (99 = not detected).
3	lc	ICCID code (if detected).

Tab. 5.33.

Models with RF 169 MHz type of remote communication

Sequence	Explanatory field	Description
1	TC	Communication Test Page.

Tab. 5.34.

Models with NB-IoT type of remote communication

Sequence	Explanatory field	Description
1	St	Strategy currently active according to standard UNI/TS 11291-12-2): <ul style="list-style-type: none"> • 0 = Normal operation (valve open); • 1 = User disconnected (valve closed); • 2 = Orphaned GdM.
2	TC	Communication Test Page.
3	EC	Value ECL 0-2 (99 = not detected).
4	RQ	Value RSRQ: 0 (-19,5 dBm) at 32 (-3dBm) (99 = not detected).
5	RP	RSRP value: 0 (-140 dBm) at 95 (-44dBm) (99 = not detected).
6	lc	ICCID code (if detected).

Tab. 5.35.

5.4 - ALARMS



The lighting of the alarm icon on the display indicates that one or more of the following error conditions are in progress:

- error in the measuring system;
- unauthorised battery door opening error (tampering);
- integrity error of the firmware code;
- temperature out of range or in error;
- reverse flow beyond threshold error (default >150 dm³, programmable).

5.5 - OPTIONAL SHUT-OFF VALVE OPENING

The previously closed shut-off valve must always go from the physical **"Closed"** state to the logical **"Re-enabled on opening"** state; this step takes place by sending the remote command for rehabilitation upon opening the Management Centre – CAS.

Proceed as described in Tab.5.36. to open the shut-off valve from the user interface:

Step	Action
1	Verify that you have obtained authorisation from the remote management centre CAS (or from the Central Acquisition System). <div style="border: 1px solid black; padding: 5px;">  NOTICE! The authorisation is bound to a time limit within which the operation must be performed and to a maximum of available attempts. </div>
2	Check the display in the "SV" valve menu, of the "VAL 40 r" writing, which identifies the enabling of the valve opening.
3	Press "Enter" to access the sub-menu. <div style="border: 1px solid black; padding: 5px;">  NOTICE! According to the relative configuration, the opening of the valve may be subject to a password being entered. </div>
4	At the end of the opening, check the display of the writing "OH (FIO)" .
5	Check the display in the "SV" valve menu, of the "VAL 00 r" writing, which identifies the valve opening.

Tab. 5.36.

After reopening of the valve, the device checks the flow to determine the presence of any leaks, only if programmed to do so, by measuring the volume gone through in the 360 seconds following re-opening.

The verification threshold can be configured with resolution in dm³.

<div style="border: 1px solid black; padding: 5px;">  NOTICE! If the set leakage threshold is exceeded, the valve is returned to: <ul style="list-style-type: none"> • "Closed" physical state; • logical "Re-enabled on opening"; spontaneously to allow the verification and resolution of leaks and then proceed with a new attempt to reopen. </div>

6 - TRANSPORT AND HANDLING

6.1 - SPECIFIC WARNINGS FOR TRANSPORT AND HANDLING

NOTICE!

Transport and handling must be carried out in compliance with the regulations in force in the country of installation by personnel who are:

- qualified (specially trained);
- familiar with accident prevention and workplace safety regulations;
- authorised to use lifting equipment.

Transport and handling

Operator qualification	<ul style="list-style-type: none"> • Installer.
PPE required	 <p>WARNING!</p> <p>The PPE listed in this table is related to the risk associated with the equipment. For the PPE required to protect against risks associated with the workplace, installation or operating conditions, please refer to:</p> <ul style="list-style-type: none"> • the regulations in force in the country of installation; • <u>any information provided by the Safety Manager at the installation facility.</u>
Weights and dimensions of the equipment	For dimensions and weights, refer to paragraph 6.2 "Physical characteristics of the equipment".

Tab. 6.37.

6.1.1 - PACKAGING AND FASTENERS USED FOR TRANSPORT

The transport packaging is designed and manufactured to avoid damage during normal transport, storage and handling. The equipment must be kept in the packaging until installation.

Upon receiving the equipment:

- make sure that no part has been damaged during transport and/or handling;
- immediately report any damage found to PIETRO FIORENTINI S.p.A..

NOTICE!

PIETRO FIORENTINI S.p.A. shall not be liable for any damage to people or property caused by accidents due to failure to comply with the instructions provided in this manual.

Tab. 6.38. describes the types of packaging used:

Ref.	Type of packaging	Image
A	Single cardboard box	

Tab. 6.38.

6.2 - PACKAGING CONTENT

The packaging contains:

Description of content

Gas meter SSM-ICON including:

- battery pack;
- communication battery pack;
- 2 plugs for the protection of the connection fittings.

NOTICE!

The batteries are already connected electrically in their operating housing.

Tab. 6.39.

NOTICE!

The use, maintenance and warning manual can be downloaded from the Manufacturer's website: <https://www.fiorentini.com>

6.3 - PHYSICAL CHARACTERISTICS OF THE EQUIPMENT

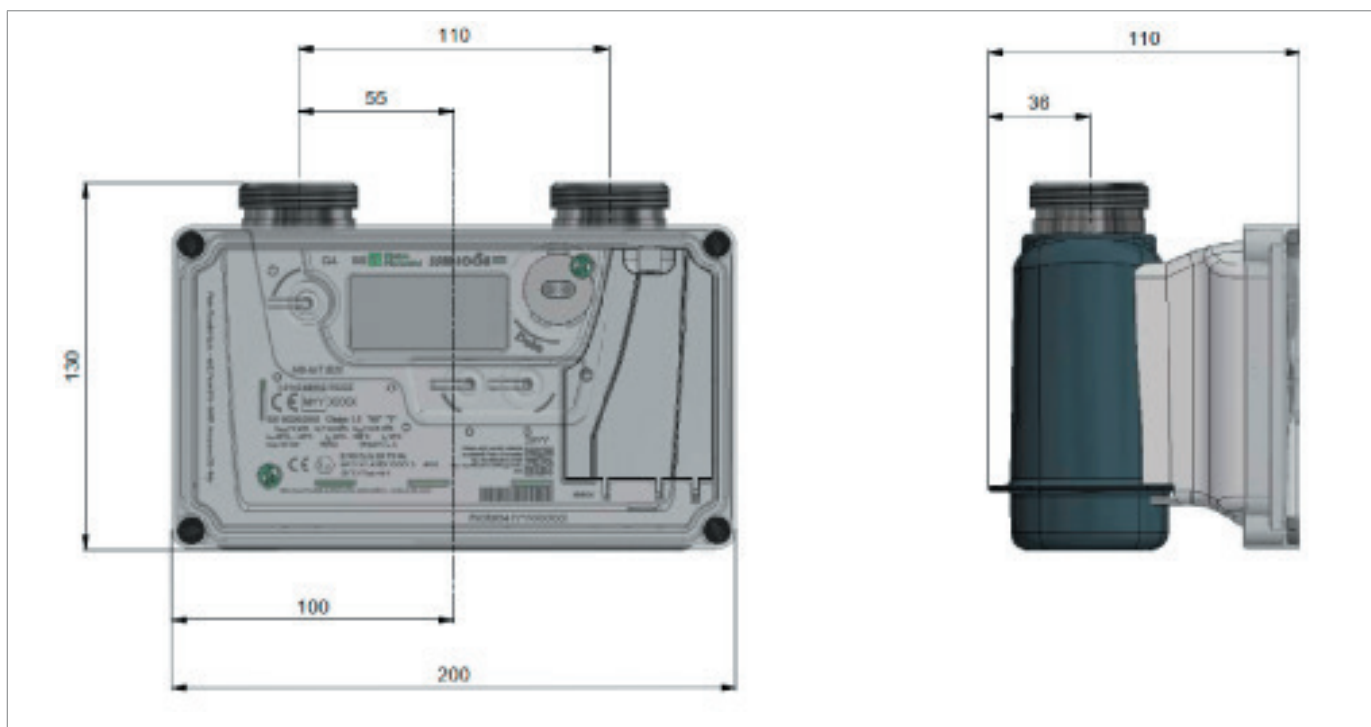

Fig. 6.5. Standard SSM-ICON Dimensions

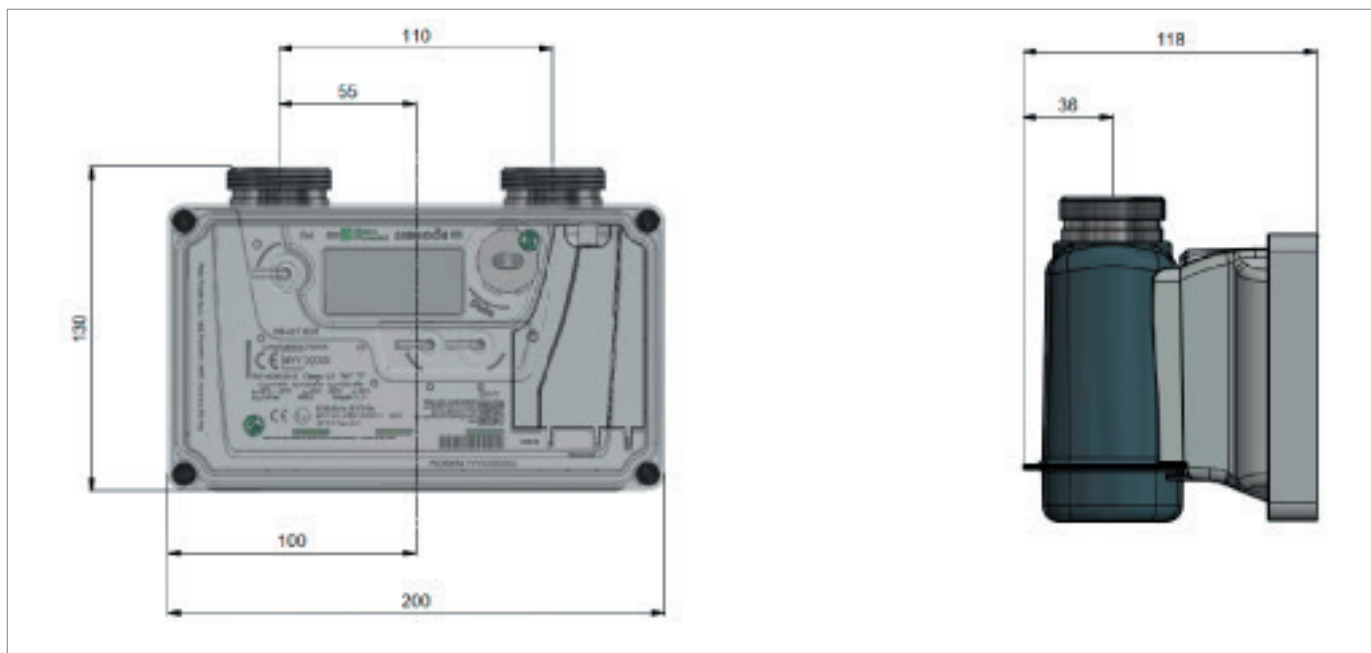

Fig. 6.6. Extended-life SSM-ICON Dimensions

Weights

STANDARD VERSION		EXTENDED-LIFE VERSION	
Standard Version without packaging	1.150 g	“Extended-life” version without packaging	1.250 g

Tab. 6.40.

6.4 - EQUIPMENT ANCHORING AND LIFTING METHOD

HAZARD!

Using lifting equipment (if necessary) for unloading, carrying and handling packages is reserved only for skilled operators who have been properly trained (and are appropriately qualified if required by the regulations in force in the country of installation) and are familiar with:

- accident prevention rules;
- workplace safety provisions;
- lifting equipment features and limits.

HAZARD!

Before handling a load, make sure that its weight does not exceed the load capacity of the lifting equipment (and any other lifting tools) specified on the specific plate.

ATTENTION!

Before moving the equipment:

- remove any movable or hanging component or firmly secure it to the load;
- protect fragile equipment;
- check that the load is stable;
- make sure to have perfect visibility along the route.

6.4.1 - FORKLIFT HANDLING METHOD

HAZARD!

It is forbidden to:

- Do not transit under suspended loads;
- Do not move the load over the personnel operating in the site/plant area.

WARNING!

The following is not allowed on forklifts:



- carrying passengers;
- lifting people.

WARNING!

During all handling operations, pay close attention to avoid impact or vibrations of the equipment batteries.

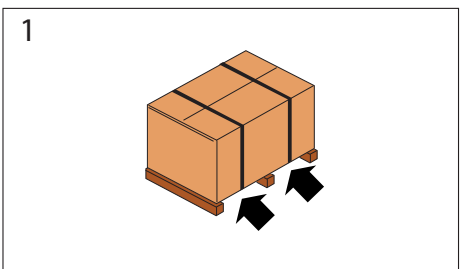
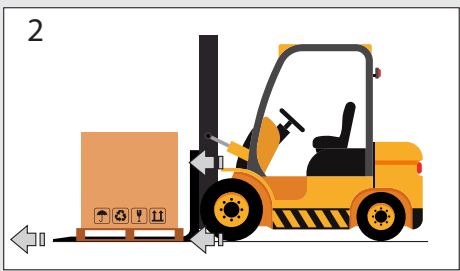
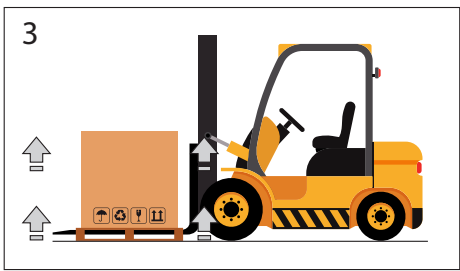
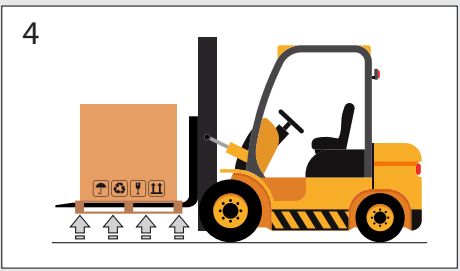
If cardboard boxes (single or multiple) are carried on a pallet, proceed as indicated in Tab.6.41.:

Step	Action	Image
1	Place the forks of the forklift under the load surface.	
2	Make sure that the forks extend from the front of the load (by at least 5 cm), far enough to eliminate any risk of the transported load from tipping.	
3	Raise the forks until they are touching the load. NOTICE! Fasten the load to the forks with clamps or similar devices if required.	
4	Slowly lift the load by a few dozen centimetres and check its stability, making sure that the centre of gravity of the load is at the centre of the lifting forks.	

Step	Action	Image
5	Tilt the mast backwards (towards the driver's seat) to help the over-turning moment and to ensure greater load stability during transport.	
6	Adjust transport speed according to the type of floor and load, avoiding sudden manoeuvres. <div style="background-color: #f4a460; padding: 5px; margin: 5px 0;">  WARNING! </div> If: <ul style="list-style-type: none"> • obstacles along the path; • particular operating situations; do not allow the operator a perfect view, the assistance of a ground operator is required, placed outside the range of action of the lifting means, with the task of signalling.	-
7	Place the load in the chosen installation area.	-

Tab. 6.41.

6.5 - PACKAGING REMOVAL

Packaging removal	
Operator qualification	<ul style="list-style-type: none"> Installer.
PPE required	<div style="display: flex; align-items: center;">  </div> <div style="background-color: #f4a460; padding: 5px; margin-top: 10px;"> <p>⚠ WARNING!</p> </div> <p>The PPE listed in this table is related to the risk associated with the equipment. For the PPE necessary to protect against risks associated with the workplace or operating conditions, please refer to:</p> <ul style="list-style-type: none"> the regulations in force in the country of installation; <u>any information provided by the Safety Manager at the installation facility.</u>

Tab. 6.42.

To unpack the cardboard boxes (single or multiple) supported by a pallet, proceed as described in Tab. 6.43.:

Step	Action
1	Remove the stretch film around the pallet.
2	Remove the 4 support corners.
3	Move the boxes of the equipment from the pallet to their intended place. <div style="border: 1px solid #0070c0; padding: 5px; margin-top: 10px;"> <p>! NOTICE!</p> <p>Have at least 2 operators manually move the packages if required due to their dimensions/weight.</p> </div>

Tab. 6.43.

! NOTICE!

After removing all packaging materials, check for any anomalies.

If there are anomalies:

- do not install the equipment;
- contact PIETRO FIORENTINI S.p.A. and specify the details provided on the equipment nameplate.

⚠ WARNING!

The single piece of equipment is contained in a specifically created cardboard box.

Avoid taking the equipment out of the box before its installation.

6.5.1 - PACKAGING DISPOSAL

! NOTICE!

Sort the various materials making up the packaging and dispose of them in compliance with the regulations in force in the country of installation.

6.6 - STORAGE AND ENVIRONMENTAL CONDITIONS

WARNING!

Protect the equipment from blows and impacts, even accidental, until it is installed.

NOTICE!

The meters must be stored in an upright position.

If the equipment needs to be stored for an extended period, the minimum environmental conditions for the intended storage are provided in Tab.6.44. Compliance with these conditions will guarantee the declared performance:

Conditions	Data
Maximum storage period	A maximum storage period is not defined as it is only limited by the life span of the product.
Storage temperature	from -25°C to +60°C
Relative humidity	95%

Tab. 6.44.

6.6.1 - STORAGE OF THE SPARE BATTERIES

Any spare battery packs ordered must be stored:

- in their original packaging or alternatively in ADR compliant packaging, by placing the containers at ground level (do not stack above 1.2 m);
- in a place with a temperature $\leq 30^{\circ}\text{C}$ in order to preserve its electrical characteristics;
- away from flammable material, water and rain, corrosive agents, heat sources;
- in the absence of direct sunlight;
- away from metal objects;
- so as to prevent any accidental movement;
- so as to prevent their terminals from bearing the weight of other elements stacked on them.

Battery packs must not be stored:

- with damaged batteries;
- with exhausted batteries.

NOTICE!

The packages are labelled in accordance with ADR, i.e. with a diamond shape on the side and code UN3090.



7 - INSTALLATION

7.1 - GENERAL WARNINGS

 **WARNING!**

The installation must be performed by qualified personnel, in compliance with the provisions in force concerning safety.

 **WARNING!**

For the safe use of the equipment, respect the permitted environmental conditions and comply with the data shown on the nameplate.

 **WARNING!**

It is strictly forbidden to make any modifications to the equipment.

 **WARNING!**

PIETRO FIORENTINI S.p.A. is not liable for damage caused by incorrect installation of the equipment and/or otherwise different from that indicated in this manual.

7.2 - INSTALLATION PRE-REQUISITES

7.2.1 - ALLOWED ENVIRONMENTAL CONDITIONS

 **NOTICE!**

For details on the allowed environmental conditions (temperature range and classification) refer to paragraph 4.3 “Technical data”.

 **WARNING!**

PIETRO FIORENTINI S.p.A. is not liable for damage and/or malfunctions caused by installation in environments other than those permitted.





7.3 - CHECKS BEFORE INSTALLATION

The installation site must be suitable for the safe use of the equipment.

The equipment installation area must have lighting that guarantees the operator good visibility during the installation phases.

Before installation, it must be ensured that:

- the installation compartment meets the provisions in force on safety and is away from any possible damage of mechanical origin, away from sources of heat or naked flames, in a dry place and protected from external agents;
- the utilities on the customer side are closed;
- there are no impediments that could hinder the installer's installation operations;
- the upstream and downstream pipes are at the same level and can bear the weight of the equipment;
- there are no stresses on the connections;
- the inlet and outlet connections of the equipment are clean and have not been damaged;
- mechanical stresses on the inlet and outlet connections are totally absent.

Installation	
Operator qualification	<ul style="list-style-type: none"> • Installer.
PPE required	<div style="display: flex; align-items: center;">      </div> <div style="background-color: #f4a460; padding: 5px; margin-top: 5px;"> <p>⚠ WARNING!</p> <p>The PPE listed in this table is related to the risk associated with the equipment. For the PPE required to protect against risks associated with the workplace, installation or operating conditions, please refer to:</p> <ul style="list-style-type: none"> • the regulations in force in the country of installation; • any information provided by the Safety Manager at the installation facility. </div>
Equipment required	Keys to fix inlet and outlet connections fittings/equipment.

Tab. 7.45.

7.4 - SPECIFIC SAFETY INSTRUCTIONS FOR THE INSTALLATION STEP

NOTICE!

The equipment is supplied with its battery packs already inserted and connected, therefore, once installed, it is ready for use.

WARNING!

Before proceeding with installation, make sure that the upstream and downstream valves installed on the line are closed.

WARNING!

Installation may also take place in areas where there is a risk of explosion, and this implies that all necessary prevention and protection measures must be taken.

For these measures, please refer to the regulations in force at the place of installation.

WARNING!

Near the equipment, do not:

- use open flames (e.g. for welding operations);
- smoke.

WARNING!

Before connecting, make sure that:

- at least the portion of the system upstream of the equipment has been cut off and that, therefore, no flow of gas occurs during installation;
- the maximum system pressure is lower than the maximum pressure set for the equipment, which is fixed and equal to 0.5 relative bar.

WARNING!

Install the equipment with the indicator device in a horizontal position, not in direct contact with the wall and raised from the floor.



WARNING!

During the equipment installation:

- avoid mechanical stresses on its inlet/outlet connections;
- implement protective measures against electrostatic discharges.

7.5 - INSTALLATION PROCEDURE

Proceed as described in Tab.7.46 for the **installation of the meter (A)**:

Step	Action
1	Remove the 2 protection caps of the connection fittings (B), if still present.
	Place the meter in the adequately prepared compartment, in the section of the line used for it.
	 NOTICE! The arrow (C) on the top of the meter indicates the direction of the gas flow and therefore, the orientation of the meter within the relative compartment.
2	Place the gaskets between the line fitting and the meter fitting.
	Connect the upstream and downstream pipes to the meter.
3	 NOTICE! <ul style="list-style-type: none"> • Use suitable fittings (if necessary) for the connection. • Tighten the fittings to a torque not exceeding 110 N/m, with suitable manual tools (see references UNI EN 14236:2018 for DN 25 and DN 32 fittings).
	Slowly charge the meter SSM-ICON with pressure and check the tightness of the connection fittings.
4	 NOTICE! The shut-off valve on the system upstream of the meter must be opened gradually. Opening the valve too quickly could damage the internal components of the meter.
5	The meter is now ready for use.
6	If present, slowly open the valve immediately downstream of the meter.

Tab. 7.46.

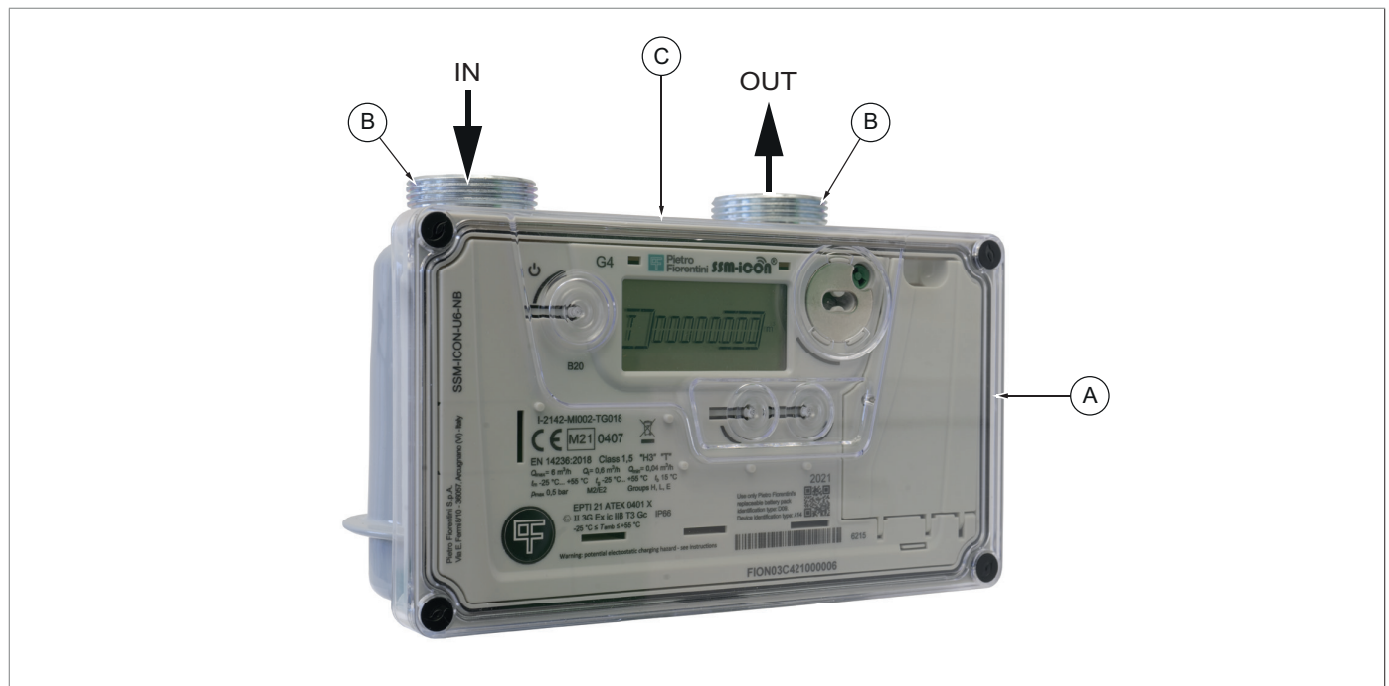

Fig. 7.7. Installation procedure

7.6 - EQUIPMENT ADJUSTMENTS

 **NOTICE!**

The equipment is adjusted as required by the Customer, directly in the facility PIETRO FIORENTINI S.p.A.
No further adjustments are required.

PAGE INTENTIONALLY LEFT BLANK

8 - CONFIGURATION

8.1 - SAFETY REQUIREMENTS FOR CONFIGURATION

Configuration	
Operator qualification	<ul style="list-style-type: none"> Specialised technician. Installer.
PPE required	 <p>WARNING!</p> <p>The PPE listed in this table is related to the risk associated with the equipment. For the PPE required to protect against risks associated with the workplace, installation or operating conditions, please refer to:</p> <ul style="list-style-type: none"> the regulations in force in the country of installation; <u>any information provided by the Safety Manager at the installation facility.</u>

Tab. 8.47.

8.2 - EQUIPMENT CONFIGURATION

NOTICE!

Equipment configuration must be carried out by authorised and qualified personnel.

NOTICE!

The device field configuration can occur from the local port or remotely from CAS, always by means of the applied protocol, as specified in the provisions of standards series UNI/TS 11291.

8.2.1 - USING THE OPTICAL PROBE

The optical probe (available as an option) is fitted with a magnetic coupling on the meter.

Place the probe head in the appropriate slot on the front part of SSM-ICON with the cable facing downwards. The magnet and the groove will retain the device in place.

To activate communication on the optical port, simply activate the display by pressing the power button. The display will turn off automatically in case of local communication inactivity for more than 2 minutes.

8.3 - VERIFY CORRECT CONFIGURATION

The checks on the equipment are carried out automatically by the CAS.

8.4 - CONNECTING TO OTHER DEVICES

There is no equipment connection SSM-ICON with external devices.

PAGE INTENTIONALLY LEFT BLANK

9 - MAINTENANCE AND FUNCTIONAL CHECKS

9.1 - GENERAL WARNINGS

HAZARD!

- Maintenance work must be carried out by qualified personnel trained on safety in the workplace and authorised to carry out equipment-related activities.
- Repair or maintenance work not provided for in this manual may be carried out only if approved by PIETRO FIORENTINI S.p.A.. PIETRO FIORENTINI S.p.A. shall not be held liable for damage to persons or property resulting from operations other than those described herein or carried out in ways other than as indicated.

HAZARD!

Special maintenance:

- requires extensive and specialised knowledge of the machines, operations required, risks involved and correct procedures to operate safely;
- must be provided by qualified, trained and authorised technicians.

WARNING!

In case of doubt, do not perform any work.

Contact PIETRO FIORENTINI S.p.A. for the necessary clarifications.

NOTICE!

Before starting maintenance on the equipment, it is advisable to make sure that the authorised operator has:

- the necessary equipment;
- appropriate spare parts.

Operate as described in Tab.9.48. in case of anomalies detected in the equipment, which require its removal and replacement from the field:

Step	Action
1	Close the shut-off valve downstream of the equipment.
2	Close the shut-off valve upstream of the equipment.
3	Replace the equipment.

Tab. 9.48.

The equipment maintenance operations are divided, from an operational point of view, into two main categories:

Commissioning and maintenance operations

Routine maintenance	<p>All those operations that the operator must preventively carry out to ensure proper operation of the device over time.</p> <div style="border: 1px solid blue; padding: 5px;"> <p> NOTICE!</p> <p>The equipment does not require routine maintenance.</p> </div>
Special maintenance	All those operations to be carried out by the operator as required by the equipment.

Tab. 9.49.

9.2 - SPECIAL MAINTENANCE

9.2.1 - REPLACING THE COMMUNICATION BATTERY PACK

Replacing the communication battery	
Operator qualification	<ul style="list-style-type: none"> Specialised technician. Maintenance Technician.
PPE required	 <p>WARNING!</p> <p>The PPE listed in this table is related to the risk associated with the equipment. For the PPE required to protect against risks associated with the workplace, installation or operating conditions, please refer to:</p> <ul style="list-style-type: none"> the regulations in force in the country of installation; any information provided by the Safety Manager at the installation facility.
Equipment required	<ul style="list-style-type: none"> Useful tool to remove the screw cover seal; Phillips screwdriver DIN EN ISO 4757 TYPE H2 (type PH2); 4 screw cover seals supplied by Pietro Fiorentini (see Paragraph 11.3); 4 self-tapping screws M4x12 (see Paragraph 11.3).

Tab. 9.50.

The equipment has been designed to ensure in field replacement of the communication battery pack in case if the charge is flat.

The following relevant data are shown on the battery pack:

- communication battery pack identification code;
- identification type of the device;
- month and year of production (or best before date).

In Tab.9.51. each SSM-ICON model is associated with the identification type of the device and the identification code of the battery pack:

Model	Identification type of the device	Identifier code communication battery pack
SSM-ICON-U6-GPRS SSM-ICON-U6-EL-GPRS	A14	D09
SSM-ICON-U6-169 SSM-ICON-U6-EL-169	A14	D09
SSM-ICON-U6-NB SSM-ICON-U6-EL-NB	A11	C01

Tab. 9.51.

HAZARD!

Batteries, especially end-of-life (exhausted) batteries, are dangerous and sensitive to shock, vibration and exposure to naked flames. Failure to comply with this document may lead to the risk of explosion, fire, harmful emissions which may have serious consequences for health.

ATTENTION!

Use only battery packs supplied by PIETRO FIORENTINI S.p.A.

ATTENTION!

All operations must be carried out:

- away from heat sources,
- in a place protected from bad weather
- as far as possible from water sources that could cause a reaction with the lithium contained inside the batteries.

ATTENTION!

Operators should not wear jewellery or metal ornaments (rings, necklaces, bracelets and earrings) that may come into contact with electronic components and/or battery terminals to avoid potential short circuits.

ATTENTION!

The fire extinguishers to be used in the event of a fire must be of class D as they are effective in extinguishing fires in the presence of lithium.

ATTENTION!

The transport of the battery packs supplied by PIETRO FIORENTINI S.p.A. must be carried out using the original packaging, which complies with the current ADR regulations.

NOTICE!

Battery replacement must be managed in such a way as not to generate false alarms.

Use the software procedure that allows you to temporarily disable the logging of fraud events and reset the estimated life meters of the communication battery pack.

If one of the following events occurs during the battery installation operations:

- battery falling to the ground;
- damage to the battery casing or swollen battery;
- battery overheating;

it is mandatory to dispose of the battery in accordance with the regulations in force (see paragraph 10.7.1) and replace it with new problem-free batteries (see paragraph 9.2.1).

For further information please contact the contact person of PIETRO FIORENTINI S.p.A.

Proceed as described in Tab.9.52. (referring to Fig.9.8.) to **replace the communication battery pack**:

Step	Action
1	Use the suitable tool to remove the 4 screw cover seals (A).
2	Unscrew the 4 fixing screws (B) of the transparent cover (C) with the Phillips screwdriver and remove it from its seat.
3	Open the door (D) that allows access to the communication battery compartment (E).
4	<p>Disconnect the communication battery connector from its housing (F) and remove the battery from the compartment.</p> <p>⚠ ATTENTION! Store the replaced communication battery in ADR compliant packaging.</p>
5	<p>Insert the connector of the new communication battery into its housing (F), then close the door (D) of the battery compartment making sure it fits in properly.</p> <p>! NOTICE!</p> <ul style="list-style-type: none"> • The connector of the battery pack is polarised so that it can only be inserted into the connector of the equipment corresponding to the correct polarity. • Position the cables (G) so as to facilitate closing the door (D) without damaging them.
6	<p>Insert the transparent cover (C) in its seat, checking that it is fully inserted, then tighten the 4 fixing screws (B) with the Phillips screwdriver.</p> <p>! NOTICE! Tightening torque 1.2 - 1.4 Nm.</p>
7	Insert the new 4 screw cover seals (A) making sure they are completely inserted in the corresponding hole.

Tab. 9.52.

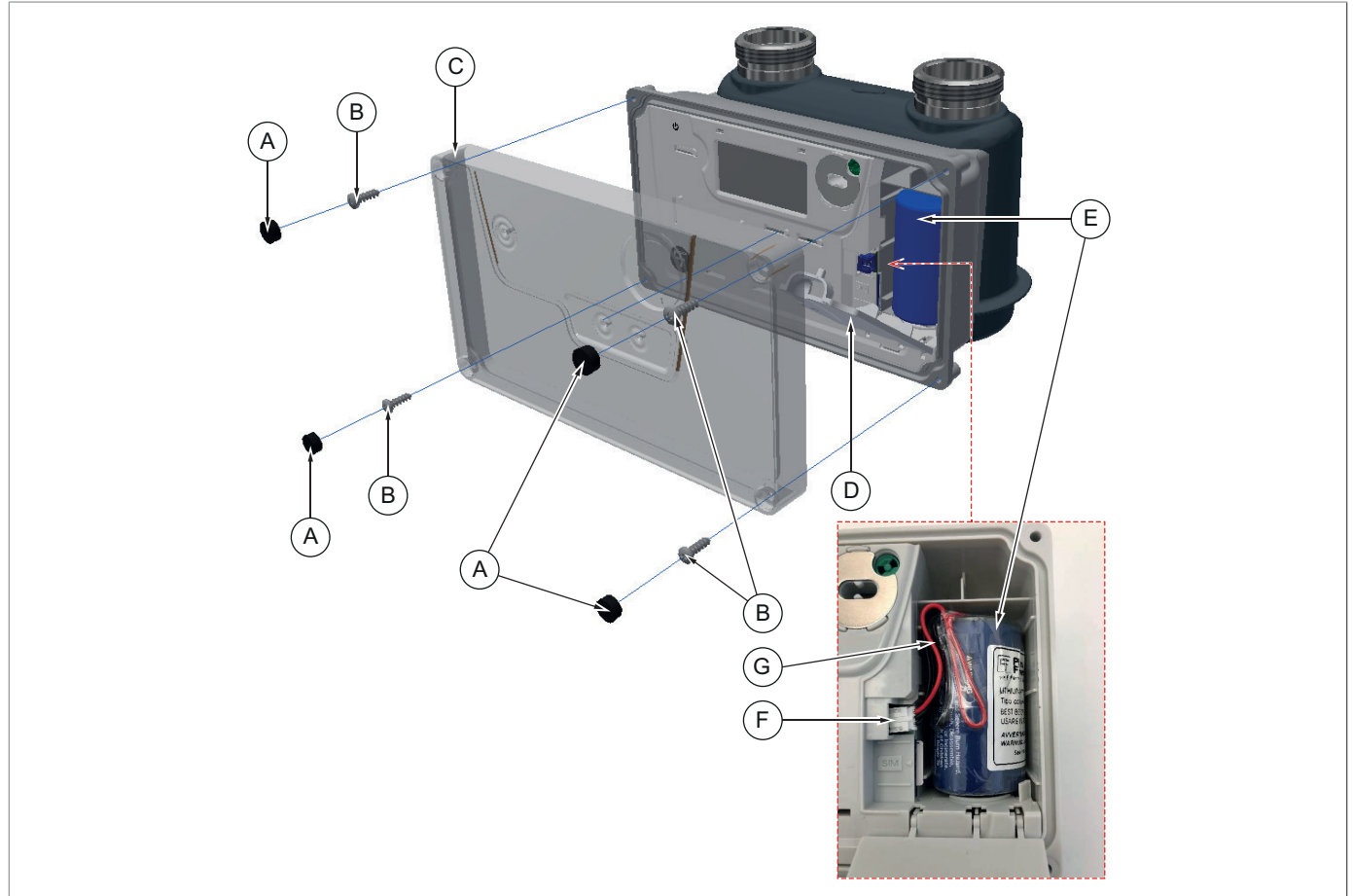



Fig. 9.8. Replacing the communication battery pack

9.2.2 - SIM REPLACEMENT (ONLY FOR SSM-ICON-GPRS AND SSM-ICON-NB) VERSIONS)

SIM replacement	
Operator qualification	<ul style="list-style-type: none"> Specialised technician. Maintenance Technician.
PPE required	 <p>WARNING!</p> <p>The PPE listed in this table is related to the risk associated with the equipment. For the PPE required to protect against risks associated with the workplace, installation or operating conditions, please refer to:</p> <ul style="list-style-type: none"> the regulations in force in the country of installation; any information provided by the Safety Manager at the installation facility.
Equipment required	<ul style="list-style-type: none"> Useful tool to remove the screw cover seal; Phillips screwdriver DIN EN ISO 4757 TYPE H2 (type PH2); 4 screw cover seals supplied by Pietro Fiorentini (see Paragraph 11.3); 4 self-tapping screws M4x12 (see Paragraph 11.3).

Tab. 9.53.

ATTENTION!

All operations must be carried out:

- away from heat sources,
- in a place protected from bad weather
- as far as possible from water sources that could react when it comes into contact with the lithium contained inside the batteries, even accidentally.

ATTENTION!

Operators should not wear jewellery or metal ornaments (rings, necklaces, bracelets and earrings) that may come into contact with electronic components and/or battery terminals to avoid potential short circuits.

ATTENTION!

The fire extinguishers to be used in the event of a fire must be of class D as they are effective in extinguishing fires in the presence of lithium.

Proceed as described in Tab.9.54. to **replace the SIM** (refer to Fig.9.9.):

Step	Action
1	Use the suitable tool to remove the 4 screw cover seals (A) .
2	Unscrew the 4 fixing screws (B) of the transparent cover (C) with the Phillips screwdriver and remove it from its seat.
3	Open the door (D) that allows access to the communication battery compartment (E) .
4	<p>Disconnect the communication battery connector from its housing (F) and remove the battery from the compartment.</p> <p>HAZARD!</p> <p>Batteries, especially end-of-life (exhausted) batteries, are dangerous and sensitive to shock, vibration and exposure to naked flames. Failure to comply with this document may lead to the risk of explosion, fire, harmful emissions which may have serious consequences for health.</p>
5	Press on the SIM (H) to activate the push/pull extraction mechanism, then extract the SIM (H1) from its seat.

Step	Action
6	Insert the new SIM (H1) and press on the SIM itself (H) to activate the push/pull insertion mechanism.
7	Insert the connector of the communication battery into its housing (F), then close the door (D) of the battery compartment making sure it fits in properly. NOTICE! Position the cables (G) so as to facilitate closing the door (D) without damaging them.
8	Insert the transparent cover (C) in its seat, checking that it is fully inserted, then tighten the 4 fixing screws (B) with the Phillips screwdriver. NOTICE! Tightening torque 1.2 - 1.4 Nm.
9	Insert the new 4 screw cover seals (A) making sure they are completely inserted in the corresponding hole.

Tab. 9.54.

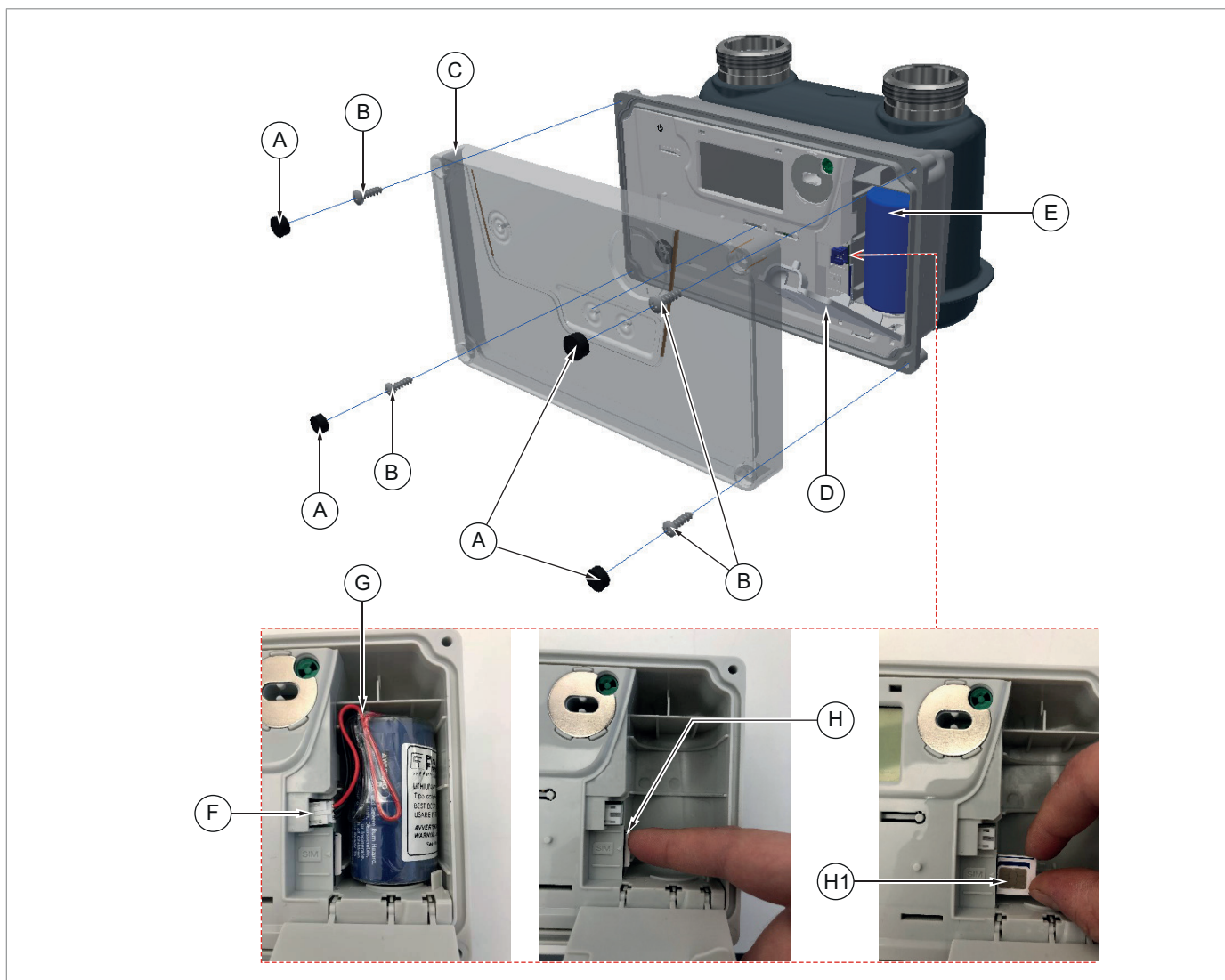

Fig. 9.9. SIM Replacement

10 - UNINSTALLATION AND DISPOSAL

10.1 - GENERAL SAFETY WARNINGS

HAZARD!



Make sure that there are no potentially explosive ignition sources in the work area set up to uninstall and/or dispose of the equipment.

WARNING!

Before proceeding with uninstallation and disposal, make the equipment safe by disconnecting it from any power supply.

10.2 - QUALIFICATION OF THE OPERATORS IN CHARGE

Uninstallation

Operator qualification	<ul style="list-style-type: none"> Installer.
PPE required	<div style="display: flex; align-items: center;">  </div> <div style="background-color: #f96; padding: 5px; margin-top: 5px;">  WARNING! </div> <p>The PPE listed in this table is related to the risk associated with the equipment. For the PPE required to protect against risks associated with the workplace, installation or operating conditions, please refer to:</p> <ul style="list-style-type: none"> the regulations in force in the country of installation; any information provided by the Safety Manager at the installation facility.
Equipment required	Keys to fix inlet and outlet connections fittings/equipment.

Tab. 10.55.

10.3 - UNINSTALLATION

To properly uninstall the equipment, proceed as specified in Tab. 10.56.:

Step	Action
1	Close the valves upstream and downstream of the equipment.
2	Disconnect the upstream and downstream pipes from the equipment by unscrewing the fittings with adequate hand tools.
3	Remove the equipment. <div style="border: 1px solid blue; padding: 5px; margin-top: 10px;">  NOTICE! Seal the valves upstream and downstream of the equipment if: <ul style="list-style-type: none"> closing the system; the equipment is not replaced immediately. </div>

Tab. 10.56.

10.4 - INFORMATION REQUIRED IN CASE OF NEW INSTALLATION

 **NOTICE!**

Should the equipment be reused after uninstallation, refer to chapters: “Installation” and “Configuration”.

10.5 - STORAGE OF THE BATTERIES

 **NOTICE!**

Refer to paragraph 6.6.1 to store the batteries.

10.6 - INFORMATION REQUIRED IN CASE OF RE-INSTALLATION

 **NOTICE!**

Refer to chapter 7 “Installation” if the equipment is to be reused after uninstallation.

10.7 - DISPOSAL INFORMATION

NOTICE!

- **Proper disposal prevents damage to people and the environment and promotes the reuse of precious raw materials.**
- **Bear in mind that the regulations in force in the country of installation must be complied with.**
- **Illegal or improper disposal involves the application of the penalties provided for by the regulations in force in the country of installation.**



When removing the device from the field, it must not be disposed of with normal waste. Dispose of the device pursuant to the provisions of It. Legislative Decree 14 March 2014, no. 49 "Implementation of directive 2012/19/EU on waste electric and electronic equipment (WEEE).

The equipment was manufactured with materials that can be recycled by specialised companies. For proper disposal of the equipment, proceed as specified in Tab. 10.57.:

Step	Action
1	Set up a large work area free from obstacles where to safely dismantle the equipment.
2	Sort the various components by type of material for easier recycling through separate collection.
3	Send the materials obtained in Step 2 to a specialised company.

Tab. 10.57.

The equipment in any configuration consists of the materials described in Tab.10.58.:

Material	Disposal/recycling indications
Plastic	It must be dismantled and disposed of separately.
Steel	Disassemble and collect separately. It must be recycled through the specific collection centres.
Stainless steel	Disassemble and collect separately. It must be recycled through the specific collection centres.
Aluminium	Disassemble and collect separately. It must be recycled through the specific collection centres.
Electronic components	Disassemble and collect separately. It must be recycled through the specific collection centres.
Lithium batteries	Refer to paragraph 10.7.1 "Disposing of the batteries".

Tab. 10.58.

NOTICE!

The above materials refer to standard versions. Different materials can be provided for specific needs.

10.7.1 - DISPOSING OF THE BATTERIES

Proceed with disposal in compliance with the requirements:

- on transport and packaging in the chapter;
- of the legislation in force in the country of installation of the equipment.

WARNING!

When disposing of the batteries, they must be removed from the equipment, as indicated in Directive 2006/66/EC art.12 paragraph 3.

The transport of the batteries to the intermediate treatment plants is not subject to the provisions of the ADR if the volume of each packaging containing the batteries does not exceed 450 litres.

NOTICE!

Take steps to prevent any leakage of battery contents under normal transport conditions.

NOTICE!

You can ship batteries and/or batteries for recycling or disposal under a partial exemption scheme, in accordance with special provision 636.

This exemption applies to lithium batteries/batteries of gross mass \leq 500 g per unit.

10.7.1.1 - BATTERY PACKAGING

NOTICE!

The packages must be labelled in accordance with ADR, i.e. with a diamond shape on the side and code UN3090.



NOTICE!

The packages must bear the indication "LITHIUM BATTERIES FOR DISPOSAL" or "LITHIUM BATTERIES FOR RECYCLING".

The batteries that are removed from the equipment must be packed in such a way:

- to be protected from any damage due to transport and handling;
- to prevent any accidental movement;
- to prevent the terminals from bearing the weight of other elements;
- to be protected from short circuits.

For this purpose, the original packaging or alternatively, packaging compliant with the ADR regulations, can be used.

If batteries not removed from the equipment but still inside it are transported, the packaging may not be approved but must still be:

- sufficiently robust and able to contain and protect the equipment;
- constructed in such a way as to prevent the equipment from operating accidentally during transport.

11 - RECOMMENDED SPARE PARTS

11.1 - GENERAL WARNINGS

NOTICE!

If spare parts not recommended are used, PIETRO FIORENTINI S.p.A. their declared performance cannot be guaranteed.

It is recommended to use original spare parts PIETRO FIORENTINI S.p.A.

PIETRO FIORENTINI S.p.A. shall not be held liable for any damage caused by using non-original parts.

11.2 - HOW TO REQUEST SPARE PARTS

NOTICE!

For specific information, please refer to the sales network of PIETRO FIORENTINI S.p.A.

11.3 - SPARE PARTS LIST

NOTICE!

Spare parts are unambiguously identified by:

- a position specified in the assembly drawing of the equipment (Fig.11.10.);
- an identification code that associates the position with the component (Tab.11.60.).

Reference to the spare parts order codes:

Pos.	Code	Component
1	SG120076216	Screw cover seal
2	SG340011327	Self-tapping screw M4x12
3	SG120076205	Plastic enclosure

Tab. 11.59.

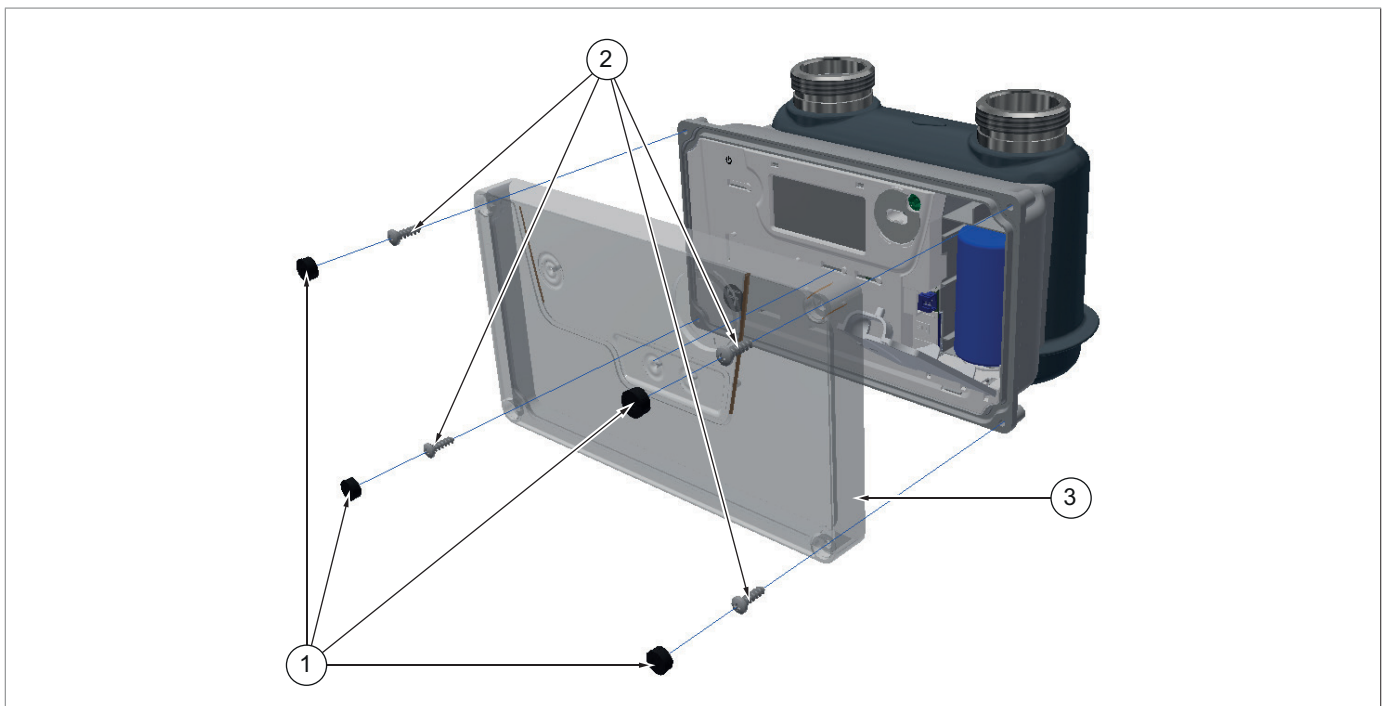

Fig. 11.10. Spare parts

11.4 - PUTTING BACK BATTERIES

Reference to the spare batteries order codes:

Model	Replacement battery code	Identifier code communication battery pack
SSM-ICON-U6-GPRS SSM-ICON-U6-EL-GPRS	SG220009013	D09
SSM-ICON-U6-169 SSM-ICON-U6-EL-169	SG220009012	C01
SSM-ICON-U6-NB SSM-ICON-U6-EL-NB	SG220009013	D09

Tab. 11.60.

PAGE INTENTIONALLY LEFT BLANK

