



User Manual

GT SERIES

1 INSTRUMENT, 7 APPLICATIONS





WARNING: ALL INDIVIDUALS WHO, HAVE OR WILL HAVE, RESPONSIBILITY FOR USING, MAINTAINING, OR SERVICING THIS PRODUCT, MUST READ THIS ENTIRE MANUAL CAREFULLY. FAILURE TO USE THIS EQUIPMENT PROPERLY COULD RESULT IN SERIOUS INJURY OR DEATH.

LEGAL STATEMENT

Teledyne, the Teledyne Logo, Gas Measurement Instruments, GMI, and GT Series are registered and/or unregistered marks of Teledyne Gas Measurement Instruments Ltd, also referred to as "the Company."

All rights reserved. No part of this documentation may be reproduced in any form or by any means or used to make any derivative work (such as translation, transformation, or adaptation) without written permission from the Company.

Microsoft, Windows, Windows 2000, Windows Me, Windows XP, Windows NT, Windows Vista, Windows 7, Internet Explorer and MS-DOS are either trademarks or registered trademarks of Microsoft Corporation in the United States and other countries. Solaris and JAVA are either trademarks or registered trademarks of Sun Microsystems, Inc. All other products or service names are the property of their respective owners.

DESCRIPTION

This User Guide provides information for use only with the GT Series Portable Gas Monitor (or "the monitor").

LIABILITY

Every care has been taken in the preparation of this user guide, but the Company does not accept any responsibility for errors or omissions and their consequences. Information in this user guide is subject to change without notice. This user guide does not constitute a specification or basis for a contract.

MODIFICATION NOTICES

The Company aims to notify customers of relevant changes in the product operation and maintain this user guide up to date. Due to continuous product improvement, there may be operational differences between the latest product and this user guide.

This user guide is an important part of the monitor, and it should be referred to for the life of the product.

SOFTWARE

Any software supplied must only be used in this product and may not be copied without the written permission of the Company. Reproduction or disassembly of such embodied programs or algorithms is prohibited. Ownership of such software is not transferable, and the Company does not warrant that the operation of the software will be error free or that the software will meet the customer's requirements.

DISPOSAL ADVICE

Dispose of the monitor carefully and with respect for the environment. If returned, the Company will dispose of the monitor without charge.

AREAS OF USE

Exposure to certain chemicals can result in a loss of sensitivity of the flammable sensor. Where such environments are known or suspected, it is recommended that more frequent response checks are carried out.

Environmental factors may affect sensor readings. This includes changes in pressure, humidity and temperature. Note that both pressure and humidity changes can also affect the amount of oxygen present in the atmosphere.

Exposure to silicones, high levels of H₂S and other sulfur-containing compounds, phosphates, and refrigerant gases (Freon) may contaminate, poison, or inhibit the sensor.

Do not use the monitor in a potentially hazardous atmospheres containing greater than 21% oxygen.



WARNING: ANY RAPID UPSCALE READING, FOLLOWED BY A DECLINING OR ERRATIC READING, MAY INDICATE A GAS CONCENTRATION BEYOND THE UPPER SCALE LIMIT, WHICH MAY BE HAZARDOUS.

SPECIAL CONDITIONS OF USE

The monitor is designed for use in harsh environments. The monitor is sealed to IP54 and, if not subjected to misuse or malicious damage, will provide many years of reliable service.

The monitor may contain electrochemical sensors. Under conditions of prolonged storage, these sensors should be removed. These sensors contain potentially corrosive liquid and care should be taken when handling or disposing, particularly when a leak is suspected.

Table of Contents

1. About This Guide	1
1.1. Guide Conventions	1
1.2. Safety.....	1
1.2.1. Additional Safety Requirement - CSA Only.....	2
1.2.2. Certifications And Approvals.....	2
1.2.3. Batteries	3
1.3. Storage, Handling and Transit	3
2. Introduction	4
2.1. Monitor Overview.....	4
2.2. Features.....	4
2.3. Monitor Ranges.....	5
2.4. Modes of Operation	5
3. Operation	6
3.1. Operation Procedure	6
3.2. Switching the Monitor ON	6
3.3. Monitor Identification.....	7
3.4. Filter Check/Flow Fault Test	7
3.4.1. Filter Check	7
3.4.2. Flow Fault Test	7
3.5. Time and Date	8
3.6. Calibration Due	8
3.7. Service Due	8
3.8. Sensor Zeroing	9
3.9. Zero Faults	9
3.10. Warm-up Complete.....	9
3.11. Switch the Monitor OFF	9
4. Modes of Operation	11
4.1. Leak Test Mode	11
4.1.1. Available Ranges.....	11
4.1.2. Features.....	11
4.1.3. Display	11
4.1.4. Button Operation	12
4.1.5. Logging	13
4.2. Confined Space Mode	14
4.2.1. Available Ranges.....	14
4.2.2. Features.....	14
4.2.3. Display	14
4.2.4. Pump.....	14

4.2.5.	Button Operation	15
4.2.6.	Logging	18
4.2.7.	Confidence Signal	18
4.3.	Barhole Mode	18
4.3.1.	Available Ranges	18
4.3.2.	Features	18
4.3.3.	Barhole Mode Operation	18
4.3.4.	Viewing Results	21
4.3.5.	Button Operation	21
4.3.6.	Barhole Faults	22
4.4.	Carbon Monoxide (CO) Mode	22
4.4.1.	Available Ranges	22
4.4.2.	Features	22
4.4.3.	CO Sub-Modes	23
4.4.4.	Button Operation	25
4.4.5.	Logging	25
4.5.	Purge Mode	26
4.5.1.	Available Ranges	26
4.5.2.	Features	26
4.5.3.	Display	26
4.5.4.	Button Operation	27
4.6.	Sniffer Mode	27
4.6.1.	Available Ranges	27
4.6.2.	Features	28
4.6.3.	Display	28
4.6.4.	Button Operation	28
4.7.	Pressure Mode	29
4.7.1.	Available Ranges	29
4.7.2.	Features	29
4.7.3.	Display	30
4.7.4.	Performing Pressure Measurements	30
4.7.5.	Button Operation	31
5.	Alarms	32
5.1.	Instantaneous Gas Alarms	32
5.2.	Time-Averaged Toxic Gas Alarms	32
5.3.	Gas Alarm Examples	33
5.4.	Gas Alarm Options	33
5.4.1.	Latching/Non Latching	33
5.4.2.	Acknowledging	33
5.4.3.	Muting	34

5.5. Warnings & Fault Alarms.....	34
5.5.1. Battery Warning	34
5.5.2. Zero Fault	34
5.5.3. Sensor Fault (After Warm-up)	35
5.5.4. Sample / Flow Fault.....	35
5.6. Default Alarm Options.....	36
6. Operator Maintenance.....	37
6.1. Replacing/Recharging Batteries.....	37
6.1.1. Replacing Batteries	37
6.1.2. Charging Batteries.....	39
6.2. Cleaning.....	44
6.3. Replacing the Filters.....	44
6.3.1. Dust Filter	44
6.3.2. Hydrophobic Filter	45
6.3.3. Chemical Filter (optional accessory).....	46
6.3.4. Cotton Filter (optional accessory)	48
7. Bump Test	50
7.1. Automatic Bump Test	50
7.2. Manual Bump Test	50
7.2.1. Bump Test Process.....	50
7.2.2. Viewing Bump Test Results	52
7.2.3. Bump Test Logging.....	53
8. Calibration	54
Calibration Validity.....	54
9. Accessories	55
9.1. Consumables.....	55
9.2. Accessories.....	55
9.3. Spare Parts.....	56
9.4. Software	56
A. Monitor Specifications.....	57
B. Technical Support	58

1. About This Guide

This guide instructs gas detection personnel on the features and usage of the GT Series of gas detectors (or “the monitor”). It also provides information on configuration, operation, maintenance, specifications and trouble shooting. This user guide assumes the reader has a basic knowledge of gas detection procedures.

1.1. Guide Conventions

The following visual elements are used throughout this guide:



WARNING: THIS ICON AND TEXT INDICATE A POTENTIALLY HAZARDOUS SITUATION, WHICH, IF NOT AVOIDED, COULD RESULT IN DEATH OR INJURY.



Caution: This icon and text indicate an action or situation, which, if not avoided, could result in damage to the equipment.



Note: This icon and text designates information of special note to the operator.

1.2. Safety

- The monitor must be regularly serviced and calibrated by fully trained personnel in a safe area.
- Only 0% to 100% LEL combustible gas detection portion of this instrument has been assessed for performance.
- Only GMI replacement parts should be used.
- If the monitor detects gas, follow your own organization’s procedures and operational guidelines.
- Any right of claim relating to product liability or consequential damage to any third party against GMI is removed if the warnings are not observed.
- Batteries: Alkaline or Rechargeable batteries must be exchanged in a safe are and fitted correctly before use. Never use damaged batteries or expose to extreme heat. See [Section 6. Operator Maintenance](#) for more details.



WARNING: TO PREVENT IGNITION OF FLAMMABLE OR COMBUSTIBLE ATMOSPHERES, REMOVE BATTERIES BEFORE SERVICING.



WARNING: TO PREVENT IGNITION OF FLAMMABLE OR COMBUSTIBLE ATMOSPHERES, READ, UNDERSTAND AND ADHERE TO THE MANUFACTURER’S MAINTENANCE PROCEDURES.



WARNING: TO REDUCE THE RISK OF IGNITION OF A FLAMMABLE OR EXPLOSIVE ATMOSPHERE, BATTERIES MUST BE CHANGED ONLY IN A LOCATION KNOWN TO BE NON-HAZARDOUS.



WARNING: TO REDUCE RISK OF EXPLOSION, DO NOT MIX OLD BATTERIES WITH USED BATTERIES OR MIX BATTERIES FROM DIFFERENT MANUFACTURERS.



WARNING: NEVER ATTEMPT TO RECHARGE NON-RECHARGEABLE CELLS.



Caution: Not for use in oxygen enriched atmospheres.



1.2.1 Additional Safety Requirement - CSA Only



Caution: Before each day's usage, sensitivity must be tested on a known concentration of Methane equivalent to 25% - 50% of full-scale concentration. Accuracy must be within 0 to +20% of actual. Accuracy may be corrected by using the GT Calibration Software and manually applying the gas.

1.2.2 Certifications and Approvals

The monitor has the following approvals:

Mark	
ATEX 	ATEX II 2 G EEx ia d IIB T3
IECEX	Ex ia d IIB T3
	Ex ia T3 C22.2 No.152
	UL 913 Class I, Div 1 Groups C and D.

This equipment is designed and manufactured to protect against other hazards as defined in paragraph 1.2.7 of Annex II of the ATEX Directive 2014/34/EU.

1.2.3 Batteries



Caution: Only use approved batteries.

1. UL APPROVED MONITORS:
 - A. Alkaline: Any 'LR14' type
 - B. Rechargeable NiMH: Any 'C' type
2. ATEX/IECEX/CSA APPROVED MONITORS:
 - A. Alkaline:
 - i. Energizer No. E93, Alkaline, (Zn/MnO₂), LR14 Size 'C' cell
 - ii. Duracell Procell, Alkaline, (Zn/MnO₂), LR14 Size 'C' cell
 - iii. Duracell Plus, Alkaline, (Zn/MnO₂), LR14 Size 'C' cell
 - iv. Duracell, Alkaline, (Zn/MnO₂), LR14 Size 'C' cell
 - B. Rechargeable:
 - i. Panasonic Type HHR-2SRE Nickel-Metal Hydride cell

1.3. Storage, Handling and Transit

- Rechargeable batteries contain energy and care should be taken in their handling and disposal.
- Remove batteries if the monitor will be stored for longer than 3 months.
- The monitor may contain electrochemical sensors with an expected life of 2 years. Under conditions of prolonged storage, the sensors should be removed. Sensors contains potentially corrosive liquid. Handle and dispose with care.

2. Introduction

2.1. Monitor Overview

The GMI GT series monitors are multifunction, multi-application gas monitors designed to suit the needs of gas industry service technicians.



Figure 1: GT Series Gas Monitor

2.2. Features

- PPM, LEL and Volume Methane (CH₄) gas ranges
- Manual and automatic datalogging
- Loud audible and high visual 'ticker' (Geiger) on ppm range
- Integral flashlight
- Alkaline or rechargeable battery options
- Charging via simple power cable or docking station
- Rugged polycarbonate case

2.3. Monitor Ranges

The following ranges are available in the GT:

- 0-10,000 ppm Methane
- 0-100% LEL Methane
- 0-100% VOL Methane
- 0-25% Oxygen (O₂)
- 0-2000 ppm Carbon Monoxide (CO)
- 0-100 ppm Hydrogen Sulphide (H₂S)
- 0 to 60 in. Water Gauge (0 to 150mBar)



Note: Your GT may not have all ranges fitted.



Note: The GT is calibrated for Methane. PPM & LEL ranges will respond to other flammable gases but will only detect Methane accurately.

Avoid exposing to flammable gases other than Methane. This can alter the performance of the flammable sensors and generate faults.

2.4. Modes of Operation

Leak Test:	Used by technicians to investigate odour or leak complaints and to pinpoint leaks.
Confined Space:	Used for confined space pre-entry testing and for personal monitoring in areas such as basements.
Barhole:	Used to locate underground leaks. This can be timed or non-timed.
CO:	Allows the user to make either CO Direct, Differential CO, or Air Free CO readings (if an O ₂ cell is fitted).
Purge:	Used in gas and air purging applications.
Sniffer:	Used to quickly find small fitting leaks using a semiconductor sensor in the probe.
Pressure:	Allows the monitor to be used as a manometer to measure appliance, regulator and system pressure for leaks.
Bump Test:	Allows the user to set up and apply gases for Bump Testing and automatically log readings. By default, this mode is disabled.

3. Operation

3.1. Operation Procedure

Check the following before use:

- The monitor is clean and in good condition.
- The hydrophobic filter is clean and in good condition.
- The clear probe filter bulb is screwed tightly and in good condition.
- The sample line and any other accessories used are in good condition.
- The batteries are in good condition, fully charged and fitted correctly.
- The battery indication provides sufficient capacity for the application.
- The monitor is within your calibration period.
- The flow fault and filter check are successful.
- All applicable ranges are operational.
- There are no fault indications.
- Attach optional accessories, as required.

3.2. Switching the Monitor ON



WARNING: ALWAYS SWITCH THE MONITOR ON IN FRESH AIR.



Figure 2: Switching the Monitor On

- Press and hold the RH button  for one second.
- A 30-second warm-up routine begins (a countdown timer appears).
- The Power ON LED and the display backlight illuminates. Both remain ON during warm-up.

- When warm-up is complete, the backlight automatically switches OFF.
- The Fault LED illuminates during the warm-up flow fault test.

Refer to [Figure 2: Switching the Monitor On](#) for more details.

3.3. Monitor Identification

During warm-up, the serial number, software version and battery status information are listed, as shown in [Figure 3: Monitor ID](#).

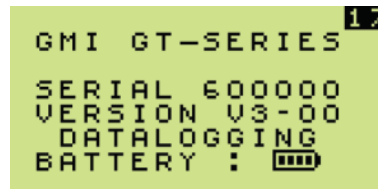

Figure 3: Monitor ID

3.4. Filter Check/Flow Fault Test

By default, this check is performed daily. This option can be enabled or disabled by the user.

3.4.1 Filter Check



Figure 4: Filter Check

- Press **YES** to continue.
- Press **NO** to enter the Switch OFF sequence.

3.4.2 Flow Fault Test

When Flow Fault Test screen is displayed (as shown in [Figure 5: Flow Fault Test](#)), there are three options:

1. Perform the Flow Fault Test.
2. Press **SKIP** to continue warm-up without performing the test.
3. Press **OFF** to initiate the Switch OFF sequence.

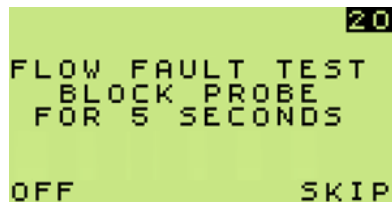

Figure 5: Flow Fault Test

To perform a flow fault test:

1. Block probe tip inlet with finger for approximately 5 seconds.
2. If successful, the pump will flow fault and the display will flash **SUCCESSFUL**, as shown in [Figure 6: Successful Test](#).
3. Select **NEXT** to switch the pump ON and continue warm-up cycle.

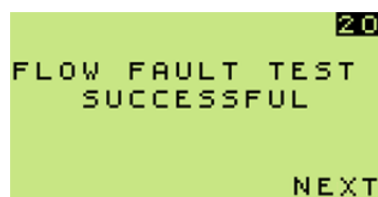

Figure 6: Successful Test

If the monitor fails the flow fault test, the screen shown in [Figure 5: Flow Fault Test](#) remains displayed.



Note: The monitor logs a successful Flow Fault test or if **SKIP** was selected.

3.5. Time and Date

The time and date are displayed as shown in [Figure 7: Time and Date](#). Verify they are correct, as they are used with datalogging.



Figure 7: Time and Date

3.6. Calibration Due

Calibration of the monitor is important.

By default, CAL DUE date is set to 365 days, but can be set to from 1 to 400 days.

The CAL DUE date is updated when the monitor is successfully calibrated.

The monitor has five options to alert the user when calibration is due or is overdue:

1. Cal Due disabled - no date is displayed. The monitor does not require a valid calibration to operate.
2. Cal Due enabled - if overdue, monitor is switched OFF.
3. Cal Due enabled - if overdue, message is displayed as shown in [Figure 8: Calibration Due Date](#), but after five seconds, the monitor warm-up continues automatically.

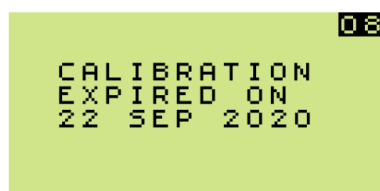



Figure 8: Calibration Due Date

4. Cal Due enabled - if overdue, message is displayed as shown in [Figure 9: Calibration Overdue](#) and the user is required to acknowledge the message before continuing the warm-up.



Note: This is the default setting.

If calibration is due, the user must either:

- Press and hold YES  button for monitor warm-up to continue.
- Press and hold NO  button to switch OFF.

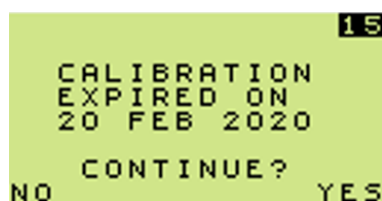

Figure 9: Calibration Overdue

5. Cal Due enabled - if overdue, user can extend the due date by up to 31 days.

If calibration is within the "extended period", the user must still acknowledge that Calibration has expired.



- Press and hold YES  button for monitor warm-up to continue.
- Press and hold NO  button to reject extended period. The screen in [Figure 10: Switch Off](#) is displayed.



Figure 10: Switch Off



Note: If the extended period option has expired, the user's only option will be to switch the monitor OFF.

3.7. Service Due

Service Due date allows essential maintenance, e.g. sensor replacement, to be programmed.

The interval can be set from 1 to 36 months.

This feature can be configured to operate in five ways - similar to the options available for CAL DUE:

1. Service Due disabled - no date is displayed.



Note: This is the default setting.

2. Service Due enabled - if overdue, the monitor is switched OFF.
3. Service Due enabled - if overdue, message is displayed as shown in [Figure 11: Service Due Date](#), but after five seconds, the monitor warm-up continues automatically.

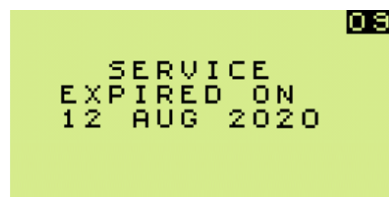

Figure 11: Service Due Date

4. Service Due enabled - if overdue, user acknowledge is required.

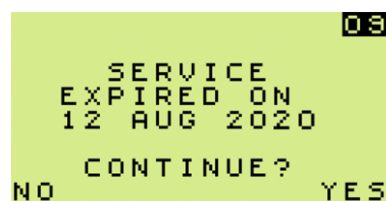

Figure 12: Service Overdue

5. Service Due enabled - if overdue, user can extend the due date by up to 31 days.



Figure 13: Service Due - Switch Off



Note: The service due date will only show at 90 days prior to the preset date.

3.8. Sensor Zeroing

At the end of warm-up, each sensor is zeroed, as shown in [Figure 14: Zero Sensors](#).



Figure 14: Zero Sensors

3.8.1 Zero Faults

If a Zero Fault is detected, the monitor should be restarted in fresh air. If the fault persists, recalibrate the monitor. If that fails, return the monitor to an approved service center.

Two types of Zero Fault are possible:

- A positive zero fault - indicated by a flashing gas reading.
- A negative zero fault - indicated by a wrench symbol alternating with a zero reading.

3.9. Warm-up Complete

The monitor automatically selects the Leak Test mode by default. The monitor can be configured to:

1. Start up in specific mode.
2. Start up in the mode last used.

3.10. Switch the Monitor OFF



Note: Allow the monitor to run for 1-2 minutes in fresh air before switching it OFF.



To switch off the monitor, press and hold both the LH  and RH  buttons simultaneously for 5 seconds (refer to [Figure 15: Switch OFF](#)).



Figure 15: Switch OFF

The mode selection menu will display for 2 seconds and then a countdown from 3 to OFF, as shown in [Figure 16: OFF Sequence](#) will begin.

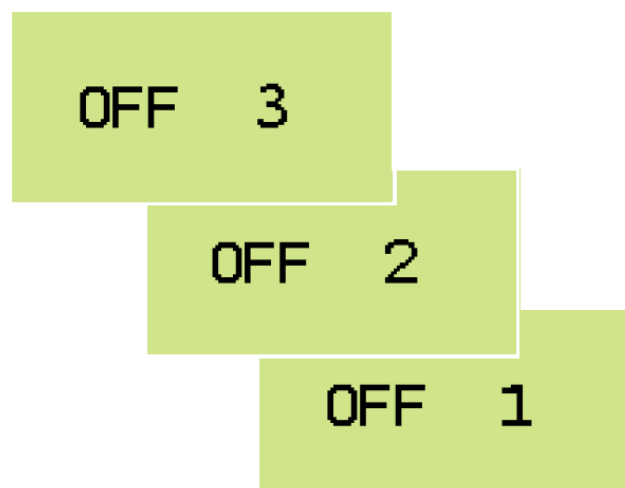

Figure 16: OFF Sequence



Note: In Confined Space Mode, to prevent accidental monitor switch OFF while alarms are active, the user must press and hold both buttons for an additional five seconds to commence the switch OFF.

4. Modes of Operation

4.1. Leak Test Mode



Note: The monitor pump must be switched ON to perform correct measurement in Leak Test mode.

This mode is used by technicians to investigate odour or leak complaints and pinpoint leaks.

4.1.1. Available Ranges

- 0 – 2000 ppm Methane. Two options are available:
 - 100 ppm dead band
 - display PPM only - no values on screen
- 0 – 100% LEL Methane
- 0 – 100% VOL Methane
- 0 – 2000 ppm Carbon Monoxide (CO) *if fitted*.

4.1.2. Features

Leak Test mode features:

- Audible / Visual PPM Ticker (Geiger) alarm
- Ticker threshold adjustment
- Audible / Visual Gas Alarms
- Pump ON / OFF (will stop automatically if flow fault is detected)
- Max Display
- Methane autoranging (ppm to LEL to Vol)
- Display Invert
- Automatic datalogging
- Backlight
- Flashlight

4.1.3. Display



Figure 17: Methane Only Display



Note: Continuous display of both Methane and CO is a configurable option, as shown in [Figure 18: Methane + CO](#).

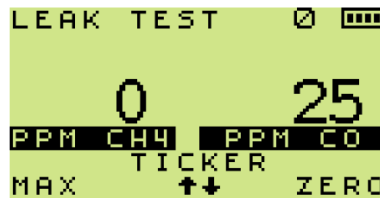

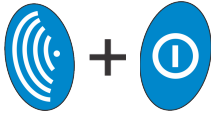





Figure 18: Methane + CO

4.1.4. Button Operation

Action	Button	Note
Invert Display	Press 	
Max¹	Press and Hold 	Displays the Maximum readings since the mode was selected. To return to live readings, press and hold again or wait 30 seconds.
Alarm Acknowledging	Press and Hold 	Available when monitor is in alarm. Refer to Section 5. Alarms for more details.
Range Selection²	Press 	Toggle between "Methane" and "Methane & CO" displays.
Lights	Press and Hold 	1st press and hold - backlight ON 2nd press and hold - flashlight ON 3rd press and hold - backlight/flashlight OFF Backlight / flashlight automatically switch OFF after two minutes.
Pump ON/OFF	Press 	
Clear Flow Fault	Press 	Available only when monitor has a flow fault alarm. Refer to Section 5. Alarms for more details.

Action	Button	Note
Zero	Press and Hold 	Zero the Methane PPM range. Pump must be switched ON.
Mode Selection	Press and Hold 	Release 1s after the mode selection menu appears. Use the UP  or DOWN  buttons to select desired mode.
Ticker (Geiger) ON/OFF	Press and Hold 	Audible and visual alarms are enabled when Leak mode is selected. To change alarms: 1st press and hold - visual only. 2nd press and hold - disable both. 3rd press and hold - enable both. When PPM autoranges to LEL, the Ticker (Geiger) continues until an LEL alarm is reached. If no LEL alarm is set, the Ticker (Geiger) remains active.
Ticker (Geiger) Adjust	Press and Hold 	When altered, the threshold setting is displayed briefly, e.g. 500 as shown in Figure 19: Ticker (Geiger) Threshold .

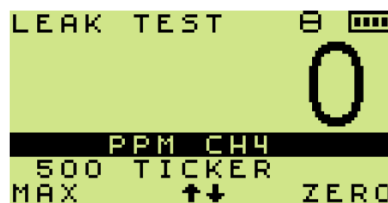

Figure 19: Ticker (Geiger) Threshold



¹Note: If the monitor is in alarm, the Max function cannot be used until the alarm is acknowledged.



²Note: An optional configurable feature enables manual selection between "PPM" and "LEL/Volume". If this option is enabled and a CO range is present, it will not be possible to only view the flammable range.

4.1.5. Logging

Automatic datalogging is active for the LEL, Volume and CO ranges. By default, these logs are recorded every minute.

4.2. Confined Space Mode

This mode is used for confined space pre-entry testing and for personal monitoring in areas such as basements.

4.2.1. Available Ranges

- 0 - 100% LEL Methane
- 0 - 25% Oxygen (O₂) if fitted
- 0 - 2000 ppm Carbon Monoxide (CO) *if fitted*
- 0 - 100 ppm Hydrogen Sulphide (H₂S) *if fitted*

4.2.2. Features

Confined Space mode features:

- Audible / Visual Alarms
- Pump ON continuously (will not stop if flow fault is detected)
- Automatic & Manual Datalogging
- Max / Min Display
- Time weighted averaging (TWA) alarms for toxic ranges
- Confidence signal every 15 seconds
- Display invert
- Backlight
- Flashlight

4.2.3. Display

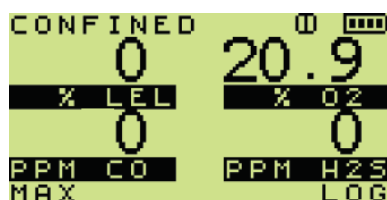

Figure 20: Normal Confined Space Display



Figure 21: Confined Space Display (in alarm)

4.2.4. Pump

The pump runs continuously for safety reasons. If a Flow Fault occurs, 'FLOW FAULT' appears on the screen and fault LED will illuminate. Refer to [Figure 22: Flow Fault Example](#).

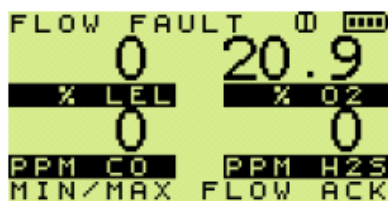

Figure 22: Flow Fault Example



4.2.5. Button Operation

Action	Button	Note
Invert Display	Press 	
Max/Min¹	Press and Hold 	1st press and hold - Maximum gas readings since the mode was selected. 2nd press and hold - Minimum O ₂ gas reading since the mode was selected. To return to live readings, press and hold again or wait 30 seconds.
Alarm Acknowledging	Press and Hold 	Available when monitor is in alarm. Refer to Section 5. Alarms for more details.
Lights	Press and Hold 	1st press and hold - backlight ON 2nd press and hold - flashlight ON 3rd press and hold - backlight/flashlight OFF Backlight / flashlight automatically switch OFF after two minutes.
Manual Log	Press and Hold 	'LOG' briefly appears on the display to confirm manual log has been stored.
Clear Flow Fault	Press and Hold 	Available only when monitor has a flow fault alarm. Refer to Section 5. Alarms for more details.
Mode Selection²	Press and Hold 	Release 1s after the mode selection menu appears. Use the UP or DOWN buttons to select desired mode.



¹Note: The Max/Min function cannot be used until the alarm is acknowledged.



²Note: To prevent inadvertently switching monitor OFF or changing mode while alarms are active, the user must press and hold both the LH  and RH  buttons simultaneously for an additional 5 seconds before the mode menu appears.

4.2.6. Logging

- Automatic datalogging is active for all ranges in this mode. By default, these logs are recorded every minute.
- Manual log - can be taken at any time.

4.2.7. Confidence Signal

Every 15 seconds during normal operation, the monitor emits a confidence beep and briefly illuminates the bottom pair of red LEDs. This informs the user that the monitor is operational and sampling.

4.3. Barhole Mode

This mode is used to locate underground leaks.

4.3.1. Available Ranges

- 0 - 100% LEL Methane. The following option is enabled:
 - 0.1% resolution up to 10% reading
- 0 - 100% VOL Methane

4.3.2. Features

Barhole mode features:

- Timed or Non-Timed Sampling
- Pump control
- Invert Display
- Six sets of barhole readings with Viewing & Overwriting
- Backlight
- Flashlight

4.3.3. Barhole Mode Operation

After accessing the Barhole mode, user can select between timed and non-timed sampling.

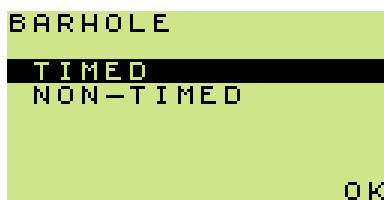





Figure 23: Barhole Sampling Types

1. To highlight the required option, press the UP  or DOWN  buttons.
2. To accept the highlighted option, press and hold OK  button.



Note: Barhole mode of the monitor can be configured to have timed, non-timed or both.

4.3.3.1. Timed Sampling

If timed sampling is selected, the user can set the barhole sample time as indicated in [Figure 24: Timed Mode \(time selection\)](#).

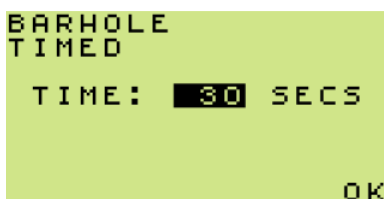





Figure 24: Timed Mode (time selection)

1. To change the sample time, press the UP  or DOWN  buttons (alterable between 10 and 300 seconds).
2. Press and hold OK  to accept.



Note: If the monitor configuration does not allow user to change this sample time, the pre-set value is displayed.

3. The monitor performs an initial purge, as shown in [Figure 25: Purge](#).

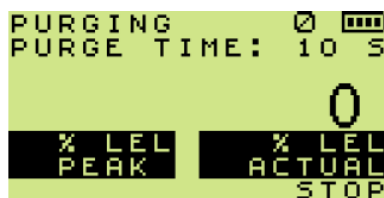



Figure 25: Purge

The purge can be stopped when the live readings reach zero; press and hold STOP  button.



Note: The minimum purge time is ten seconds.

4. BARHOLE 1 is displayed as shown in [Figure 26: Barhole 1 & Timer](#).

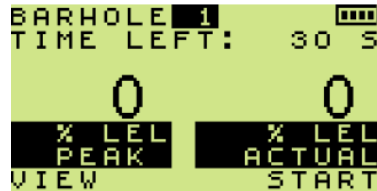





Figure 26: Barhole 1 & Timer

5. Up to six barhole readings can be stored. These are identified as 'BARHOLE 1' to 'BARHOLE 6'. User can specify where the next reading is stored by pressing the UP  and DOWN  buttons. This allows previous readings to be overwritten.
6. Press and hold START  button to begin sampling. This will start the timer and pump. After sampling is completed, the pump switches OFF and the peak and actual (sustained) readings are displayed as shown in [Figure 27: Barhole Readings](#).

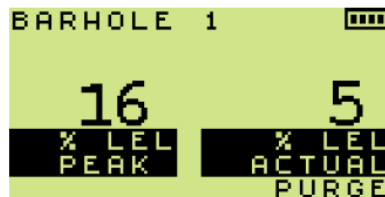



Figure 27: Barhole Readings

7. Between Barhole tests there is a Purge that removes any residual gas from the monitor before the next barhole is sampled. When complete, the peak reading is blanked from the display, as shown in [Figure 28: Purge Complete](#).



Figure 28: Purge Complete

4.3.3.2. Non-Timed Sampling

Non-timed sampling operates like Timed, except the user is required to stop the sampling by pressing the STOP  button. See [Figure 29: Non-Timed Purge](#) where user has allowed the monitor to sample for 10s.

```

BARHOLE 1 0
SAMPLE TIME: 10 S
0 0
% LEL % LEL
PEAK ACTUAL
VIEW START

```

Figure 29: Non-Timed Purge

4.3.4. Viewing Results

- To view previous barhole results press and hold VIEW  button.

```









PEAK ACTUAL
1 10%LEL 5%LEL
2 2%LEL 0%LEL
3 5%LEL 5%LEL
TIME
LIVE

```

Figure 30: View Barhole Results

- To return the display to barhole operation, press and hold LIVE  button.

4.3.5. Button Operation

Action	Button	Note
Invert Display	Press 	
	Press and Hold 	
View Results	Press and Hold 	
	Press and Hold 	1st press and hold - backlight ON 2nd press and hold -flashlight ON 3rd press and hold - backlight/flashlight OFF Backlight / flashlight automatically switch OFF after two minutes.
Clear Flow Fault	Press and Hold 	Available only when monitor has a flow fault alarm. Refer to Section 5. Alarms for more details.
	Press and Hold  + 	Release 1s after the mode selection menu appears. Use the UP  or DOWN  buttons to select desired mode.

4.3.6. Barhole Faults

If a Flow Fault or Bead Fault is detected, the pump stops automatically. Sampling is aborted if in progress. A Purge cycle will commence.

Flow Fault or Bead Fault are recorded as shown in [Figure 31: Flow Fault](#) and [Figure 32: Bead Fault](#).

	PEAK	ACTUAL
1	1%LEL	1%LEL
2	2%LEL	0%LEL
3	5%LEL	5%LEL
4	FLOW FAULT	
5	--	--
6	--	--
LIVE		

Figure 31: Flow Fault

	PEAK	ACTUAL
1	1%LEL	1%LEL
2	2%LEL	0%LEL
3	5%LEL	5%LEL
4	BEAD FAULT	
5	--	--
6	--	--
LIVE		

Figure 32: Bead Fault

4.4. Carbon Monoxide (CO) Mode

The CO mode is used to check the interior of premises and appliances for CO leakage.

4.4.1. Available Ranges

- 0 - 25% Oxygen (O₂) *if fitted*
- 0 - 2000 ppm Carbon Monoxide (CO)

4.4.2. Features

Carbon Monoxide mode features:

- Four display options:
 - CO Direct
 - Differential
 - Air Free
 - CO Viewing
- Pump ON / OFF
- Automatic & Manual Datalogging
- Invert Display
- Backlight
- Flashlight

4.4.3. CO Sub-Modes

CO mode has four configurable sub-modes as shown in [Figure 33: CO Menu](#). If your monitor only has one enabled, the CO Menu will not be available.

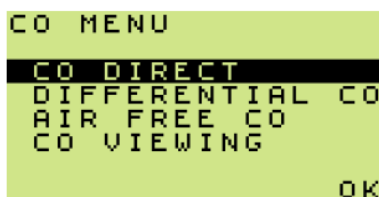





Figure 33: CO Menu

1. To highlight the required option, press the UP  or DOWN  buttons.
2. Press and hold OK  button to accept.

4.4.3.1. CO Direct

In this option, normal atmospheric air is checked for CO content. A typical display for this mode is shown in [Figure 34: CO Direct](#).



Figure 34: CO Direct

4.4.3.2. Differential CO

This option enables the user to zero out ambient or background levels of CO and then display the differential measurement. This is useful in areas where the ambient CO might be impacted from other sources, e.g. traffic pollution.

A typical display is shown in [Figure 35: Differential CO](#).

To zero the displayed CO reading, press and hold the ZERO  button

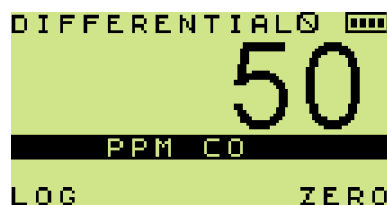

Figure 35: Differential CO

4.4.3.3. Air-Free CO

Air-free CO is the CO reading modified by the O₂ reading. This measurement is only available when an O₂ sensor is fitted. This measurement assists in determining if the emissions from an unventilated appliance (e.g. oven or a stove/cooker) are safe.

$$\text{CO Air-free} = (20.9 \times \text{CO}) / (20.9 - \text{O}_2)$$

An Air-Free CO reading is not available if the O₂ reading is above 19%, as shown in [Figure 36: Air-Free CO \(invalid sample\)](#).



Figure 36: Air-Free CO (invalid sample)

The Air-Free CO reading is available once the O₂ reading is less than 19%, as illustrated in [Figure 37: Air-Free CO \(valid sample\)](#).

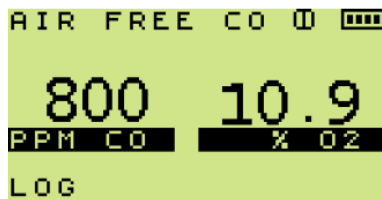



Figure 37: Air-Free CO (valid sample)

4.4.3.4. CO Viewing

This allows the user to view the six most recent manually logged readings, as shown in [Figure 38: CO Viewing Display](#).

	TIME	CO	PPM
4	01:03	A/F	554
3	01:02	DIF	43
2	01:02	DIFZ	38
1	01:01	DIR	38
-	-:-:-	---	---
-	-:-:-	---	---
CLEAR			OK

Figure 38: CO Viewing Display











If enabled, a CO Viewing screen will also be displayed when entering any of the other three sub-modes (press and hold OK  button to proceed).



Note: A Differential CO ('DIF') reading will only be valid if there is a preceding Differential CO Zero ('DIFZ') on the list. Otherwise 'zzz' fault indication will be displayed instead of the gas value.

To CLEAR all readings from the display, press and hold CLEAR  button.

4.4.4. Button Operation

Action	Button	Note
Invert Display	Press 	
Manual Log	Press and Hold 	'LOG' briefly appears on the display to confirm manual log has been stored.
Clear Log Entry	Press and Hold 	CO viewing sub-mode only.
Lights	Press and Hold 	1st press and hold - backlight ON 2nd press and hold -flashlight ON 3rd press and hold - backlight/flashlight OFF Backlight / flashlight automatically switch OFF after two minutes.
Pump ON/OFF	Press 	
Clear Flow Fault	Press 	Available only when monitor has a flow fault alarm. Refer to Section 5. Alarms for more details.
Zero	Press and Hold 	Zero the CO range. Pump must be switched ON.
Mode Selection	Press and Hold  + 	Release 1s after the mode selection menu appears. Use the UP  or DOWN  buttons to select desired mode.

4.4.5. Logging

Automatic datalogging is active for all CO sub-modes. By default, these logs are recorded every minute.

- Direct CO and Differential CO - the direct CO reading is logged.
- Air-Free CO - the calculated reading is logged.

A manual log can be taken at any time.

A manual zero will also be logged.

4.5. Purge Mode

The purge mode is used in direct and indirect purging applications.

4.5.1. Available Ranges

- 0 - 100% VOL Methane
- 0 - 25% VOL Oxygen (O₂) *if fitted*

4.5.2. Features

Purge mode features:

- Pump ON / OFF
- Manual zero
- Display Invert
- Backlight
- Flashlight

4.5.3. Display

By default, Purge mode only displays the Methane VOL reading as shown in [Figure 39: Purge Mode - default display](#).

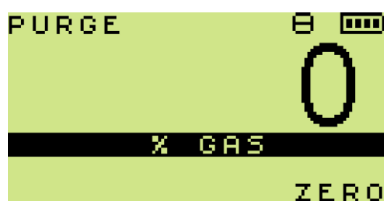



Figure 39: Purge Mode - default display

To display both Methane and O₂ as shown in [Figure 40: Purge Mode - dual range display](#), press the RANGE  button.

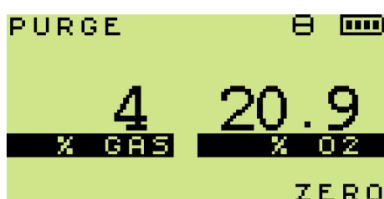











Figure 40: Purge Mode - dual range display

4.5.4. Button Operation

Action	Button	Note
Invert Display	Press 	
Range Selection	Press 	
Lights	Press and Hold 	1st press and hold - backlight ON 2nd press and hold -flashlight ON 3rd press and hold - backlight/flashlight OFF Backlight / flashlight automatically switch OFF after two minutes.
Pump ON/OFF	Press 	
Clear Flow Fault	Press 	Available only when monitor has a flow fault alarm. Refer to Section 5. Alarms for more details.
Zero	Press and Hold 	Zero the Methane range. Pump must be switched ON.
Mode Selection	Press and Hold 	Release 1s after the mode selection menu appears. Use the UP  or DOWN  buttons to select desired mode.

4.6. Sniffer Mode

This mode is used to quickly find small fitting leaks using a semiconductor sensor in the probe.

4.6.1. Available Ranges

- 0 - 10,000 ppm Methane

4.6.2. Features

Sniffer mode features:

- Audible / Visual Ticker (Geiger) alarm
- Pump ON / OFF (will stop automatically if flow fault is detected)
- Ticker threshold adjustment
- Display Invert
- Backlight
- Flashlight









4.6.3. Display



Figure 41: Sniffer Mode - default display

4.6.4. Button Operation

Action	Button	Note
Invert Display	Press 	
Lights	Press and Hold 	1st press and hold - backlight ON 2nd press and hold -flashlight ON 3rd press and hold - backlight/flashlight OFF Backlight / flashlight automatically switch OFF after two minutes.
Pump ON/OFF	Press 	
Clear Flow Fault	Press 	Available only when monitor has a flow fault alarm. Refer to Section 5. Alarms for more details.
Zero	Press and Hold 	Zero the Methane PPM range. Pump must be switched ON.

Action	Button	Note
Mode Selection	Press and Hold  + 	Release 1s after the mode selection menu appears. Use the UP  or DOWN  buttons to select desired mode.
Ticker (Geiger) ON/OFF	Press and Hold  + 	Audible and visual alarms are enabled when Leak mode is selected. To change alarms: 1st press and hold - visual only. 2nd press and hold - disable both. 3rd press and hold - enable both. When the PM autoranges to LEL, the Ticker (Geiger) continues until an LEL alarm is reached. If no LEL alarm is set, the Ticker (Geiger) remains active.
Ticker (Geiger) Adjust	Press and Hold  + 	When altered, the threshold setting is displayed briefly, e.g. 500 as shown in Figure 19: Ticker (Geiger) Threshold .

4.7. Pressure Mode

In this mode, the monitor can be used as a manometer and measure appliance, regulator and system pressure for leaks.



Note: Zero the pressure mode in ambient atmosphere before taking measurements.



Note: The pump is always OFF in Pressure mode.

4.7.1. Available Ranges

- 0 - 60in Water Gauge (resolution - 0.1 in) (default)
- 0 - 150mBar (resolution 1mBar)



Note: EEE (Over-range) is displayed if the pressure measurement exceeds 60in./150mBar.

4.7.2. Features

Pressure mode features:

- Display Invert
- Backlight

4.7.3. Display

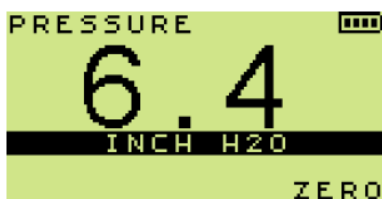

Figure 42: Pressure Mode (inch H₂O)



Note: A configurable option display the pressure reading in mBar as shown in [Figure 43: Pressure Mode \(mBar\)](#).



Figure 43: Pressure Mode (mBar)

4.7.4. Performing Pressure Measurements







1. Zero the monitor before tubing is attached by pressing and holding ZERO  button.
2. Connect the tubing from the appliance to the pressure port on the rear of the monitor, as shown in [Figure 44: Tubing Connected to Pressure Port](#).



Figure 44: Tubing Connected to Pressure Port

4.7.5. Button Operation

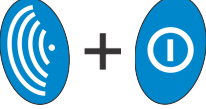
Action	Button	Note
Invert Display	Press 	
Screen Backlight ON/OFF	Press and Hold 	Backlight automatically switch OFF after two minutes.
Zero	Press and Hold 	Zero the pressure range.
Mode Selection	Press and Hold 	Release 1s after the mode selection menu appears. Use the UP  or DOWN  buttons to select desired mode.

5. Alarms

Alarm set-points (instantaneous, STEL and LTEL) are factory set. It is important to verify that the set-points are in accordance with your company's requirements and with local health and safety legislation.

Alarm levels can be changed, refer to the [SET-UP SOFTWARE USER HANDBOOK](#) (part no. 67162).

5.1. Instantaneous Gas Alarms

- When an alarm set-point has been reached, the audible and visual alarms will activate to alert the user.
- Alarms only operate once the monitor warm-up is complete.
- All gas alarms are configurable to meet the specific needs of the user.

Refer to the table of [Default Set-Points of Gas Alarms](#) for more details.

5.2. Time-Averaged Toxic Gas Alarms

In some modes the monitor also calculates the Short-Term Exposure Limit (STEL) and Long-Term Exposure Limit (LTEL / TWA) for toxic gas ranges.



Note: A time-averaged value is the mean average gas level over a rolling period. The STEL is 15 minutes and the LTEL/TWA is 8 hours. In accordance with legislation, this requires the time weighted averages to be averaged over a full period whether the monitor is ON or OFF. Such averaging essentially makes the monitor single user applicable. An option is available to restart the averaging after each monitor switch-off, making it multiple user applicable.



Note: Because readings are averaged, it is possible to get a 'live reading' of zero and have a LTEL or STEL alarm active.

Refer to the table of [Default Set-Points of Gas Alarms](#) for more details.

Default Set-Points of Gas Alarms				
	Methane	O ₂	CO	H ₂ S
LO	N/A	Disabled	N/A	N/A
LOLO	N/A	19.5% Vol	N/A	N/A
HI	Disabled	Disabled	Disabled	Disabled
HIHI	20% LEL	23% Vol	35ppm	15ppm
STEL	N/A	N/A	200ppm	10ppm
LTEL/TWA	N/A	N/A	30ppm	5ppm



Note: Alarms are only available in Leak Test and Confined Space modes. By default, Leak Test mode has all the alarm set-points in the table of [Default Set-Points of Gas Alarms](#) disabled.

5.3. Gas Alarm Examples

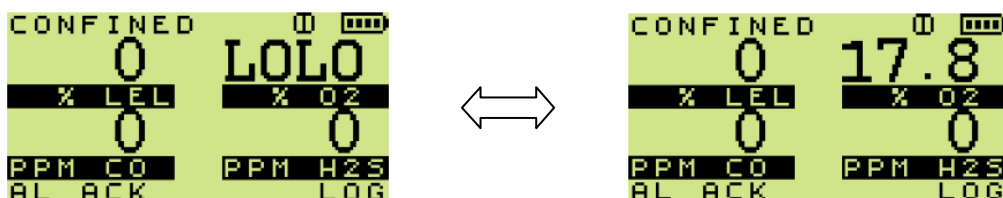

Figure 45: LOLO Oxygen Alarm

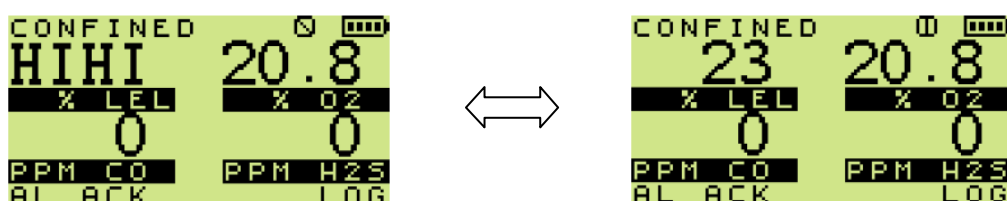

Figure 46: HIHI LEL Alarm

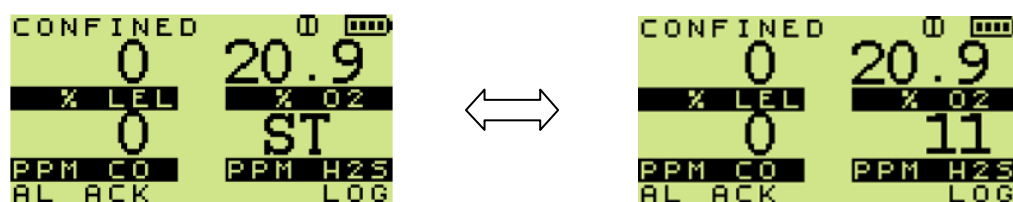

Figure 47: STEL H₂S Alarm

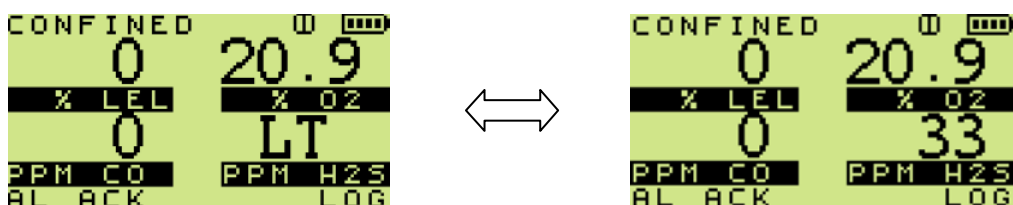



Figure 48: LTEL H₂S Alarm

5.4. Gas Alarm Options

5.4.1 Latching/Non Latching

Alarms are individually programmable to be either latching or non-latching:

- Latching - alarms can only be reset once gas readings have returned to a safe level. To reset, press and hold the AL ACK  button.
- Non-Latching - alarms will automatically reset when the gas readings have returned to a safe level.

5.4.2 Acknowledging

User can acknowledge a latching alarm by pressing and holding the AL ACK  button. This can only be done after the atmosphere has returned to safe concentrations.

5.4.3 Muting

- Alarms can be individually programmable to be mutable.
- This means the audible alarm can be muted for 60 seconds.
- After 60 seconds, if the alarm conditions still exist, the alarm will reactivate.
- Muting is achieved by a press and hold of the LH  button.

5.5. Warnings & Fault Alarms

5.5.1 Battery Warning

The battery  symbol alternates with LO when approximately 30 minutes of runtime remain. Recharge the monitor or replace the alkaline batteries.

The battery  symbol flashes when approximately three minutes of runtime remain.



Note: Audible and visual gas alarms continue to operate when the low battery warning message appears.

5.5.2 Zero Fault

If the monitor is switched on in gas and has been unable to zero all sensors correctly, a 'ZERO FAULT' message is displayed.

- A flashing spanner (wrench) alternating with a gas value, as shown in [Figure 49: Zero Fault \(LEL\)](#).
- The audible alarm sounds, and the orange fault LED flashes.
- If the user is in a mode where the faulty sensor is used, the orange LED is on, continuously.

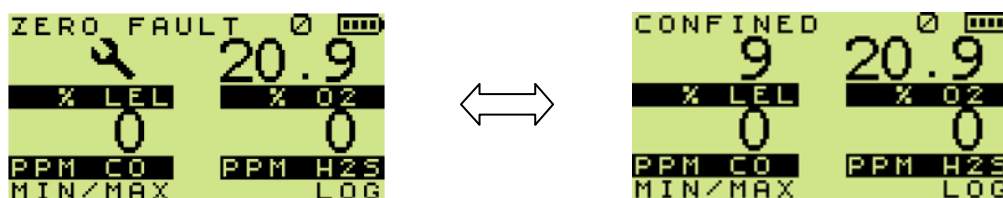

Figure 49: Zero Fault (LEL)

Return the monitor to fresh air and switch it off and on. If the fault persists, return the monitor for service.

If a Zero Fault exists, the monitor can still be used to detect and alarm on all the other ranges fitted.

5.5.3 Sensor Fault (After Warm-up)

There are two types of sensor faults:

- 'ZERO FAULT' and a spanner (wrench) symbol alternating with a zero reading, as illustrated in [Figure 50: Zero Fault](#).
 - Apply relevant test gas for two minutes and then remove it.
 - Allow the display to return to zero.
 - Switch monitor OFF and ON again.

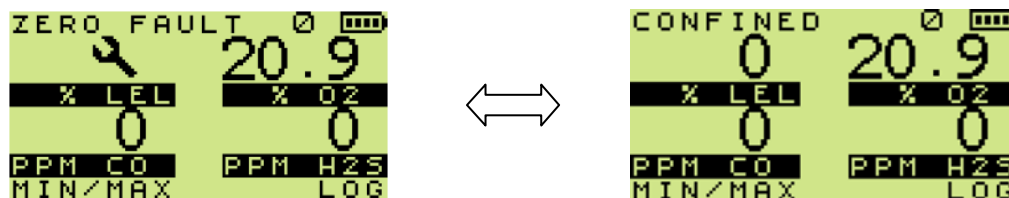

Figure 50: Zero Fault

- If the fault persists, return the monitor for service.
- 'ZERO FAULT' and a spanner (wrench) symbol, alternating with a gas reading, as illustrated in [Figure 49: Zero Fault \(LEL\)](#).
 - Leave monitor ON for 30 to 60 minutes.
 - Switch it OFF and ON.
 - If the fault persists, return the monitor for service.

5.5.4 Sample / Flow Fault

If a sample fault occurs, 'FLOW FAULT' alternates with the mode name, as shown in [Figure 51: Flow Fault \(CSM\)](#).

- Pump switches off (except Confined Space mode)
- Pump symbol disappears
- Fault LED turns ON.

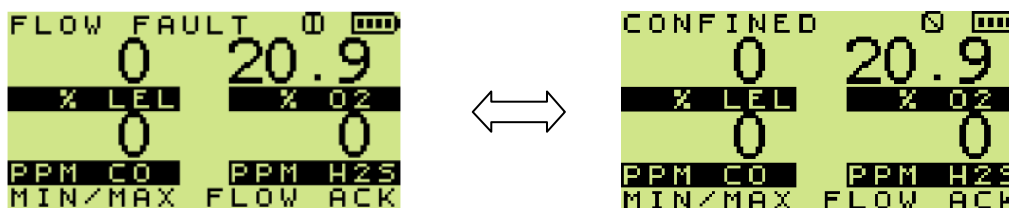



Figure 51: Flow Fault (CSM)

Check sample line, filter or probe for blockage. Clear blockage then restart the pump by pressing the FLOW ACK  button.

5.6. Default Alarm Options

Alarm Type	Latching?	Mutable?	Audible Indication	Visual LED Indication
LEL Warning		Alarm disabled by default		
LEL (HI)	N	Y	High Pitch	4x LED Flashing
LEL (HIHI)	Y	N	High Pitch	8x LED Ramping
O ₂ (LO)		Alarm disabled by default		
O ₂ (LOLO)	Y	N	High Pitch	8x LED Ramping
O ₂ (HIHI)	Y	N	High Pitch	8x LED Ramping
CO Warning	N	N/A	N/A	N/A
CO (HI)		Alarm disabled by default		
CO (HIHI)	Y	N	High Pitch	8x LED Ramping
CO (STEL)	Y	N	High Pitch	8x LED Ramping
CO (LTEL/TWA)	Y	N	High Pitch	8x LED Ramping
H ₂ S Warning		Alarm disabled by default		
H ₂ S (HI)		Alarm disabled by default		
H ₂ S (HIHI)	Y	N	High Pitch	8x LED Ramping
H ₂ S (STEL)	Y	N	High Pitch	8x LED Ramping
H ₂ S (LTEL/TWA)	Y	N	High Pitch	8x LED Ramping
Low Battery	Y	N/A	Low Pitch	Fault LED Flashing
Zero Fault	Y	N/A	Low Pitch	Fault LED ON
Sensor Fault	Y	N/A	Low Pitch	Fault LED Flashing
Flow Fault	Y	N/A	Low Pitch	Fault LED Flashing
Calibration Expired	Y	N/A	Low Pitch	Fault LED Flashing
Service Expired	Y	N/A	Low Pitch	Fault LED Flashing

6. Operator Maintenance

6.1. Replacing/Recharging Batteries

The monitor's handle contains three "C" size batteries (see [Figure 52: GT Series Battery Location](#)).

Refer to [Section 1.2.3 Batteries](#) for the allowed battery types.

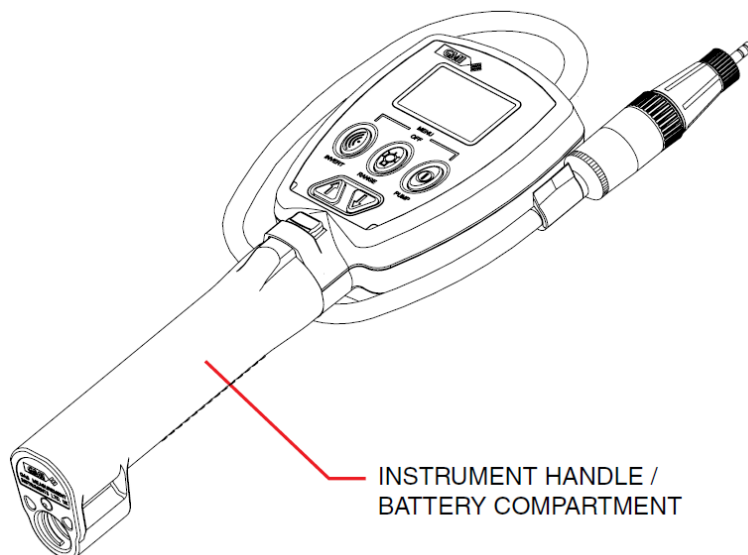

Figure 52: GT Series Battery Location

6.1.1 Replacing Batteries



WARNING: BATTERIES MUST BE CHANGED ONLY IN A LOCATION KNOWN TO BE NON-HAZARDOUS.



WARNING: DO NOT MIX NEW BATTERIES WITH USED BATTERIES OR MIX BATTERIES FROM DIFFERENT MANUFACTURERS.



WARNING: DO NOT MIX ALKALINE AND RECHARGEABLE BATTERIES.



WARNING: TO PREVENT IGNITION OF FLAMMABLE OR COMBUSTIBLE ATMOSPHERES, ALWAYS REMOVE BATTERIES BEFORE SERVICING THE MONITOR.



WARNING: TO PREVENT IGNITION OF FLAMMABLE OR COMBUSTIBLE ATMOSPHERES, READ, UNDERSTAND AND ADHERE TO THE MANUFACTURER'S MAINTENANCE PROCEDURES.

1. Unscrew the captive thumb screw from the battery cover assembly.
2. Press the securing catch to release the battery cover assembly.
3. Remove the cover in direction shown in [Figure 53: Battery Cover Removal](#).

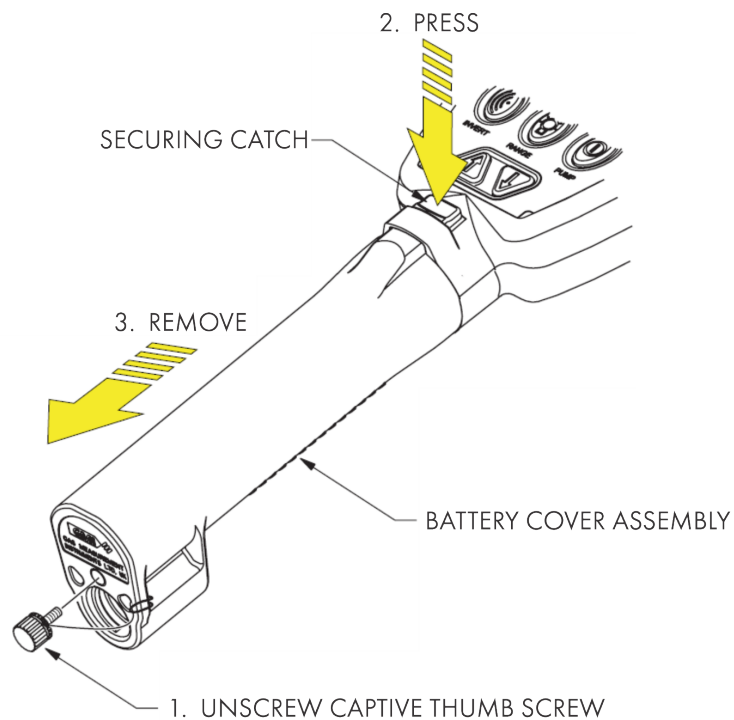
**Figure 53: Battery Cover Removal**

4. Remove the three batteries, as shown in [Figure 54: Battery Removal](#).

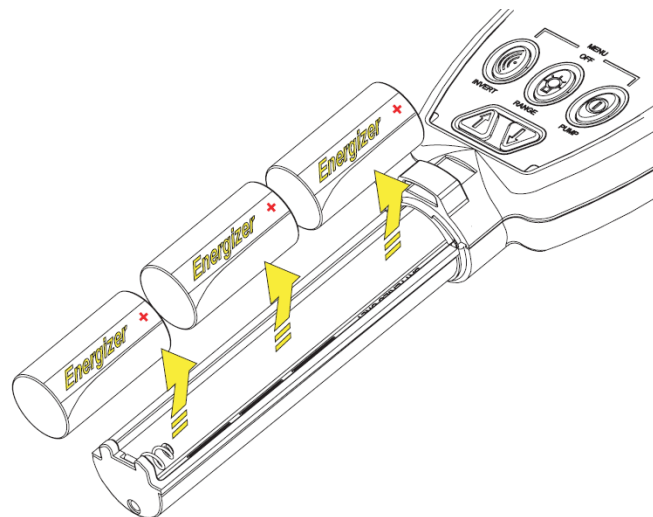
**Figure 54: Battery Removal**

5. Replace Batteries - note polarity as shown in [Figure 54: Battery Removal](#).
6. Check the O-ring ([Figure 55: O-Ring Replacement](#)) for damage and replace if necessary.

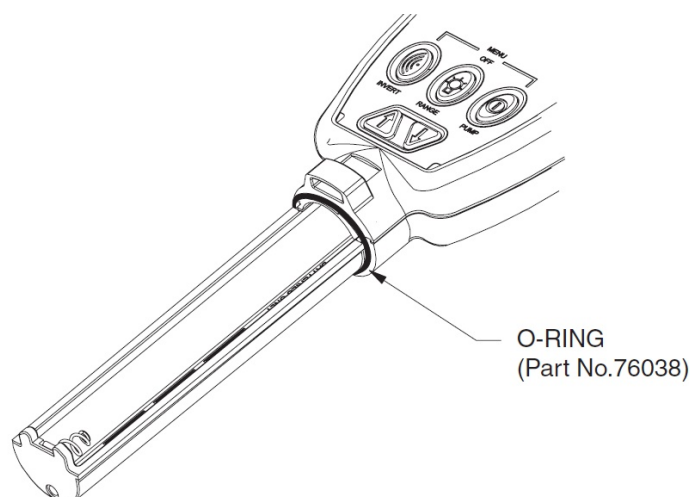

Figure 55: O-Ring Replacement

7. Reattach all parts (reverse of removal procedure).

6.1.2 Charging Batteries



WARNING: NEVER RECHARGE NON RECHARGEABLE CELLS.



Caution: Switch the monitor off when charging batteries.

There are three options for charging batteries fitted inside the monitor:

- Standard Monitor Charger (Part No. 67134).
- Charging Station (Part No.67101), used with Universal Power Supply (Part No. 12444), 12V Power Supply (Part No. 12988) or 24V Reduction Box (Part No.67233).
- A 12V/24V Vehicle Instrument Charger (Part No. 66206).

(The rechargeable batteries can also be removed from the monitor and charged in an appropriate, commercially available charger.)

During charging, the display indicates 'CHARGING IN PROGRESS' together with the pulsing battery icon, as shown in [Figure 56: Charging in Progress](#).



Figure 56: Charging in Progress

The green 'Power' LED is on during charging.

When charging is complete, the screen shown in [Figure 57: Charging Complete](#) is displayed.



Figure 57: Charging Complete

If 'CHARGING TERMINATED' is displayed, as shown in [Figure 58: Charging Terminated](#), an excessive charge voltage exists that may have been caused by attempting to charge Alkaline batteries. The orange (fault) LED will also be ON.



Figure 58: Charging Terminated

6.1.2.1 Standard Monitor Charger (Universal Plug)

To connect Standard Charger to the monitor:

1. Lift dust cover from charger socket on rear of monitor. Connect charger plug, as shown in [Figure 59: Connect Charger to Monitor](#).

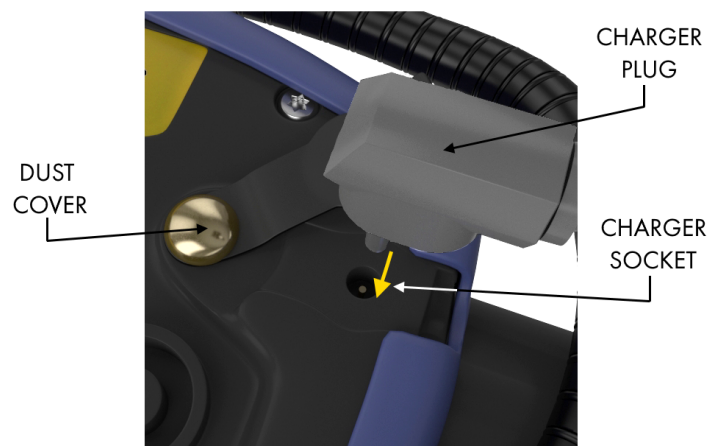

Figure 59: Connect Charger to Monitor

2. Connect charger to mains supply.

The charging period may vary depending upon operational conditions such as temperature and the condition of the batteries.

6.1.2.2 Charging Station

The charging station, shown in [Figure 60: GT Series Charging Station](#), will also locate the monitor securely while charging.

Refer to [Charging Station Instruction Sheet \(P/N 67252\)](#) for more details.



Figure 60: GT Series Charging Station

To insert monitor in charging station:

1. Check that monitor charging contacts (shown in [Figure 61: Monitor Charging Contacts](#)) and the station charging contacts (shown in [Figure 62: Charging Station - Monitor Location](#)) are clean.



Figure 61: Monitor Charging Contacts

2. Ensure the monitor is switched OFF.
3. Locate the hole on the base of the monitor handle and insert onto the charging station, refer to [Figure 60: GT Series Charging Station](#).
4. Secure monitor into the storage clip and engage securing strap, refer to [Figure 62: Charging Station - Monitor Location](#).



Figure 62: Charging Station - Monitor Location

5. Secure the probe in the charging station, as shown in [Figure 60: GT Series Charging Station](#).
6. Connect power supply, (Universal Power Supply (part no. 12444) or 12V Vehicle Power Supply (part no. 12988)) to Charging Station as shown in [Figure 63: Power Supply to Charging Station](#).



Figure 63: Power Supply to Charging Station

6.1.2.3 12V / 24V Vehicle Charger

The 12V / 24V Vehicle Charger (shown in [Figure 64: Vehicle Charger Lead](#)) provides the option of charging the monitor from a vehicle cigarette lighter socket.

A red LED on the charger plug indicates 'power on'.



Figure 64: Vehicle Charger Lead

6.2. Cleaning



Caution: Do not use agents containing silicon or solvent to clean the monitor as these may damage the flammable gas sensor.

Caution: Do not use abrasive materials or strong volatile chemical solutions as these could damage the impact resistant casing.

The outer, impact resistant casing of the monitor may be cleaned using a non-abrasive moist cloth. Rub the cloth over the outer casing to remove any dirt. A mild soap solution may be used with a non-abrasive cloth to remove more stubborn marks.

6.3. Replacing the Filters

The monitor is fitted with dust and hydrophobic filters. These protect the monitor from the ingress of dust and moisture. The filters are located in the probe and must be inspected periodically for contamination or damage.



WARNING: A LEAK CHECK MUST BE PERFORMED AFTER ANY FILTER REPLACEMENT.

6.3.1 Dust Filter

1. Unscrew the dust filter holder and detach it from the probe adaptor, as illustrated in [Figure 65: Dust Filter Holder / Filter Removal](#).
2. Remove and discard the dust filter.



Caution: Always replace a dirty Dust Filter. Never rotate and reuse as this can introduce contaminants into the monitor.

3. Insert a new dust filter (Part No. 67163) in the dust filter holder until fully seated.
4. Check the dust filter washer and replace if damaged (Part No. 67189).
5. Reattach the dust filter holder to the adaptor and secure.



Note: Do not overtighten the dust filter holder.

6. Switch ON the monitor and check that a 'FLOW FAULT' is displayed when the probe inlet is blocked (while pump is running).
7. If 'FLOW FAULT' is not displayed, check tightness of all fittings.

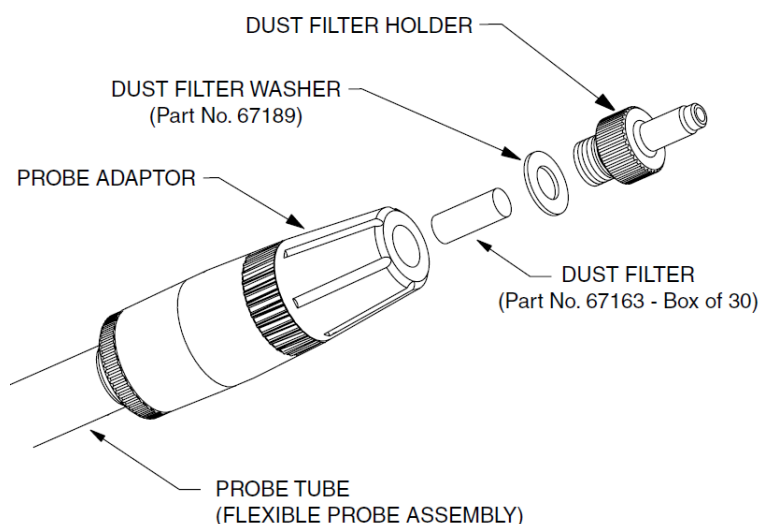

Figure 65: Dust Filter Holder / Filter Removal

6.3.2 Hydrophobic Filter



Note: When replacing the hydrophobic filter, you must also replace the dust filter.



Caution: The monitor must be OFF when replacing the hydrophobic filter. Ensure any dust / dirt falls away from the monitor.

1. Remove and discard the dust filter, as detailed in [Section 6.3.1 Dust Filter](#).
2. Unscrew the probe adaptor, as illustrated in [Figure 66: Hydrophobic Filter Bulb Removal](#).
3. Turn the hydrophobic filter bulb in an anticlockwise direction to release the bayonet connection.



Note: The hydrophobic filter is permanently attached to the hydrophobic filter bulb.

4. Inspect the hydrophobic filter for contamination or damage.
5. Fit a new Hydrophobic Filter Bulb (Part No. 67213), if required.
6. Check the probe washer and replace if damaged (part no. 12379).



Note: Do not overtighten the hydrophobic filter bulb or probe adaptor filter assembly.

7. Switch ON the monitor and check that a 'FLOW FAULT' is displayed when the probe inlet is blocked (while pump is running).
8. If 'FLOW FAULT' is not displayed, check tightness of all fittings.

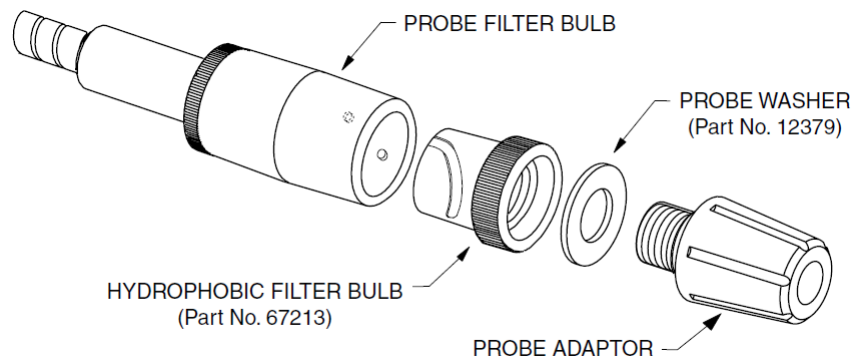

Figure 66: Hydrophobic Filter Bulb Removal

6.3.3 Chemical Filter (optional accessory)

The Chemical Filter assembly (Part no. 67142) is available as an accessory. The filter contents can be replaced with any of the following:

- Charcoal Granules (part no. 67148)
Charcoal removes higher hydrocarbons from the sample.
- Silica Gel (part no. 67205)
Silica Gel removes moisture from a sample.
The Gel will change colour from gold to green when saturated and replacement is required.
- NO_x absorber (part no. 67270)
The NO_x absorber will remove Nitric Oxide (NO) and Nitrogen Dioxide (NO₂) from a sample.
The absorber will change colour from dark purple to brown when saturated and replacement is required.



Caution: The contents of this filter must only be replenished with Teledyne GMI approved chemicals.



Note: When replacing the chemical filter, you must also replace the dust filter.

1. Remove and discard the dust filter, as detailed in [Section 6.3.1 Dust Filter](#).
2. Remove the probe adaptor from the chemical filter assembly, as shown in [Figure 67: Filter Removal](#).
3. Unscrew the chemical filter assembly from the hydrophobic filter bulb, as illustrated in [Figure 67: Filter Removal](#).

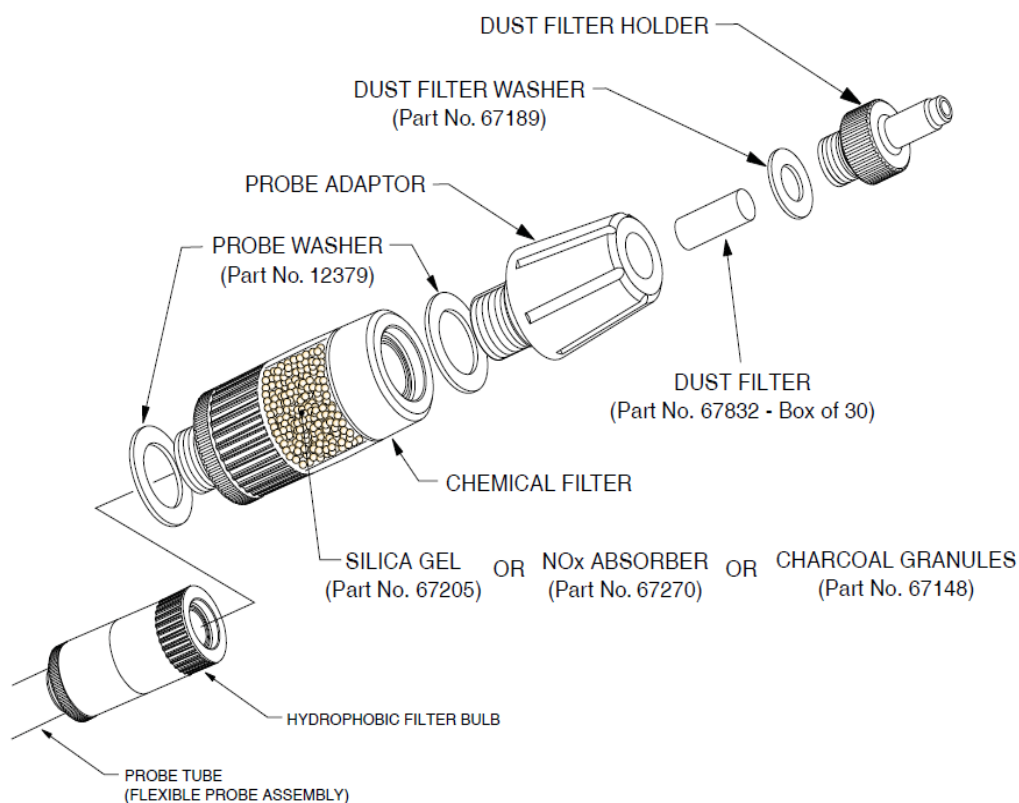

Figure 67: Filter Removal

4. If the content of the chemical filter is to be replaced, hold the filter assembly in the upright position, as shown in [Figure 68: Filter Housing Adaptor Removal](#).

Unscrew the filter housing adaptor.

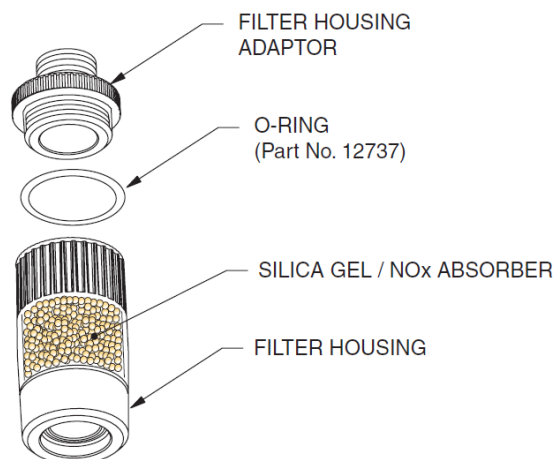
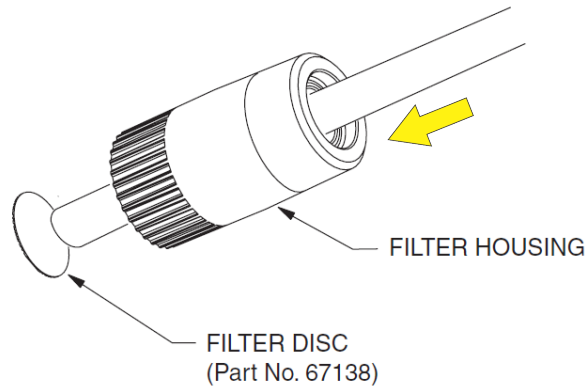

Figure 68: Filter Housing Adaptor Removal

5. Discard the filter housing content.
6. The chemical housing filter disc must be replaced if it is damaged or contaminated.

Using the flat end of a pencil, push the filter from the sample side, as shown in [Figure 69: Housing Filter Removal](#), and discard it.

Insert new filter disc (part no. 67138) into filter housing until fully seated.

**Figure 69: Housing Filter Removal**

The housing adaptor filter must also be replaced if damaged or contaminated.

Using the flat end of a pencil or similar, push the filter from the open end of the adaptor, as shown in [Figure 70: Filter Adaptor Removal](#), and discard the filter.

Insert new filter disc (Part No. 67199) into adaptor recess until correctly seated.

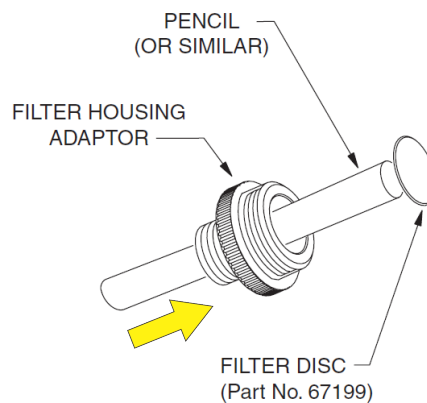
**Figure 70: Filter Adaptor Removal**

7. Fill the filter housing to a level just below the internal threads. Do not overfill.
8. Reattach all parts (reverse of removal procedure).



Note: Do not overtighten the probe adapter or chemical filter.

6.3.4 Cotton Filter (optional accessory)

The cotton filter assembly (part no. 67196) contains a cotton filter to further protect the monitor from the ingress of dust.

The cotton filter housing can be removed using the same procedure as the chemical filter. Refer to [Section 6.3.3 Chemical Filter \(optional accessory\)](#) and [Figure 71: Cotton Filter Removal](#).

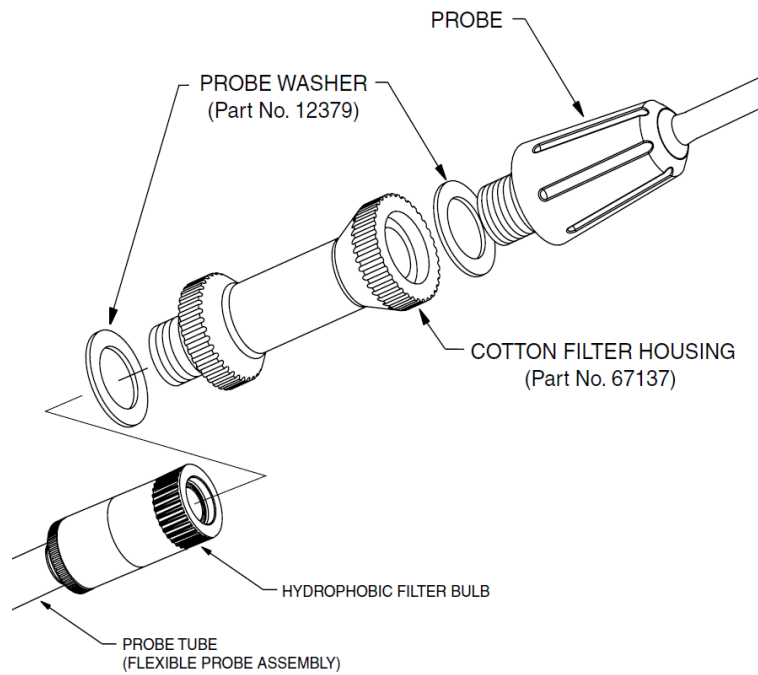

Figure 71: Cotton Filter Removal

1. Using a pencil, push the cotton filter from the threaded end of the housing, as shown in [Figure 72: Cotton Filter Removal](#), then remove it.

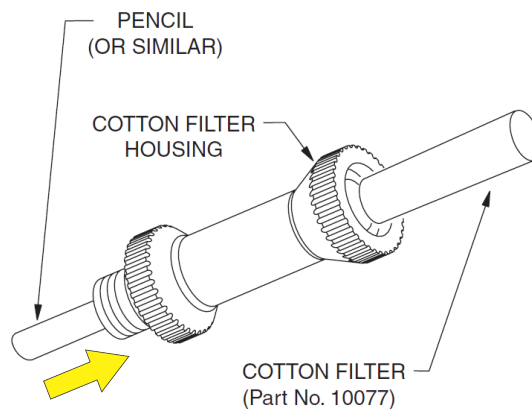

Figure 72: Cotton Filter Removal

2. Replace the cotton filter if it is contaminated or damaged (part no. 10077).
3. Check the probe washers and replace if damaged (Part no. 12379).
4. Reattach all parts (reverse of removal procedure).



Note: Do not to overtighten the probe adapter or cotton filter housing.

7. Bump Test

A bump test verifies sensor response and alarm operation by exposing the monitor to a known concentration of gas.

There are two bump test options:

- Automatic - using GT Calibration Station
- Manual - using the monitor's Bump Test Mode



Note: By default, Bump Test Mode is disabled.

7.1. Automatic Bump Test

For details on bump testing using the GT calibration station, please refer to the following documents:

- [Calibration Station \(Individual Gases\) Instructions](#) - part no. 67295
- [Calibration Station \(Mixed Gases\) Instructions](#) - part no. 67296

7.2. Manual Bump Test

The manual bump test is an optional mode.

Press and hold both the LH  and the RH  buttons to enter the mode selection menu and then select 'BUMP TEST' (as shown in [Figure 73: Modes of Operation](#)).

```
LEAK TEST
CONFINED SPACE
BARHOLE
CO
PURGE
SNIFFER
PRESSURE
BUMP TEST OK
```

Figure 73: Modes of Operation

7.2.1 Bump Test Process

The first bump test mode screen is shown in [Figure 74: CalGas Selection](#).

```
CALGAS1 20AUG20
PPM
LEL
VOL
O2
CO
H2S
NEXT LAST OK
```

Figure 74: CalGas Selection



Note: Bump Test mode will only display gas ranges configured in the monitor.

Multiple gas cylinders may be required to fully bump test the monitor.

Each gas cylinder used is referenced using a CalGas number.

For example:

- CalGas1 - Methane PPM
- CalGas2 - Methane LEL
- CalGas3 - Methane Vol
- CalGas4 - CO/H₂S

1. The current CalGas selection number is highlighted. A different CalGas number can be selected by pressing the UP or DOWN buttons.

In the example in [Figure 75: Example CalGas Cylinder](#), a cylinder of 50% LEL is assigned to CalGas2.

```

CALGAS2  20AUG20
PPM
LEL    50
VOL
O2
CO
H2S
NEXT   LAST   OK
  
```

Figure 75: Example CalGas Cylinder

2. To enter/edit the gas cylinder concentration, press and hold the NEXT button to highlight the gas value to be altered (as shown in [Figure 76: Enter/Edit CalGas Value](#)). Press the UP or DOWN buttons as necessary to enter the correct gas value.



Note: Pressing and holding either of the buttons will rapidly increase/decrease the gas value.

```



CALGAS2  20AUG20
PPM
LEL    50
VOL
O2
CO
H2S
NEXT   LAST   OK
  
```

Figure 76: Enter/Edit CalGas Value

3. Once the monitor has been programmed with the actual gas cylinder content, press and hold the OK button to start the test. The screen shown in [Figure 77: Applied Gas Peak Values](#) will be displayed.

CALGAS2		PEAK
PPM		-
LEL	50	0
VOL		-
O2		-
CO		-
H2S		-
	EXIT	OK

Figure 77: Applied Gas Peak Values

- Left column - gas ranges available in the monitor
 - Middle column - concentration of gas being applied
 - Right column - peak gas reading
4. Apply the gas using a demand flow regulator.
 5. Once the peak reading has stabilized, disconnect the gas.
 6. Either exit the Bump Mode and store the values automatically or go back to the CalGas menu to define and apply gas from another cylinder.
 - Exit the Bump Mode - press and hold the EXIT  button.
 - Return to CalGas selection display - press and hold OK  button.



7.2.2 Viewing Bump Test Results

From CalGas set-up screen (shown in [Figure 75: Example CalGas Cylinder](#)), press and hold LAST  button to view the results of the last 32 bump tests.

The screen shown in [Figure 78: Previously Stored Bump Tests](#) will be displayed.

20AUG20	08:35
21AUG20	08:44
22AUG20	08:27
23AUG20	09:03
24AUG20	08:20
25AUG20	08:56
26AUG20	08:23
NEXT	↑ ↓ OK

Figure 78: Previously Stored Bump Tests

- Use the UP  or DOWN  buttons to highlight the required results.
- Press and hold the NEXT  button to select.

Once selected, the stored bump test reading will be shown (as illustrated in [Figure 79: Stored Bump Test Readings](#)).

20AUG20	08:35
PPM	800 789
LEL	50 49
VOL	100 101
O2	0.1 0.7
CO	500 513
H2S	50 47
	OK

Figure 79: Stored Bump Test Readings

To return to CalGas Display, press and hold the OK  button.

7.2.3 Bump Test Logging

All manual bump tests results will be automatically stored in the monitor's memory when the mode is exited using the EXIT  button.

Up to 32 bump tests are stored in chronological order. When more bump tests are performed, the oldest result will be over-written.

Results can be extracted from the monitor using the GT Data Downloading software (part no. 67164).

8. Calibration

The monitor has been calibrated for particular gases. Where any doubt exists, return the monitor to an authorized distributor for calibration.



WARNING: ONLY AUTHORIZED PERSONNEL MAY CALIBRATE THE MONITOR.

Three methods of calibration are possible:

1. Field Calibration. See [Configuration and Field Calibration Handbook \(Part no. 67160\)](#) for further details.
2. The GMI GT-Series Calibration software. This allows the monitor to be linked to a PC and calibrated while applying gas manually. See [GTCAL Software User Handbook \(Part no. 67244\)](#) for further details.
3. The GMI GT-Series Automatic Calibration System. This provides controlled delivery of individual / mixed gases, allowing calibration with records stored on a PC.



Note: For further information on calibration options, please contact Teledyne GMI or an authorized distributor.

8.1. Calibration Validity

Calibration validity remains the responsibility of the user. Individual codes of practice may dictate calibration intervals.

Regular calibration establishes a pattern of reliability and enables the calibration check period to be modified in line with operational experience. As a guide, the higher the risk, the more frequently calibration should be checked.

9. Accessories

Accessories and spare parts available for the GT series monitors are as follows:

9.1. Consumables

Part No.	Description
67163	Dust Filter - Box of 30
67196	Cotton Filter
10077	Cotton Filter - Box of 10 (<i>use with 67196</i>)
67138	Filter Disc - Filter Housing (<i>use with 67142</i>)
67199	Filter Disc - Filter Adaptor (<i>use with 67142</i>)
67148	Bottle of Charcoal Granules (<i>use with 67142</i>)
67205	Bottle of Colour Indicated Silica Gel (<i>use with 67142</i>)
67270	Bottle of NO _x Absorber (<i>use with 67142</i>)
67292	Drycell (Alkaline) batteries (pack of 3)
67294	Panasonic Rechargeable Batteries (pack of 3)

9.2. Accessories

Part No.	Description
67108	Carrying Case
12480	35cm (14in) Solid End Probe
12393	80cm (32in) Solid End (Barhole) Probe
67185	Stainless Steel (Flue) Probe
67142	Chemical Filter Assembly
12712	Sample Line (Tygon) - per metre
67095	Wrist Strap
67134	Standard Monitor Charger (Universal Plug)
66206	12V/24V Vehicle Monitor Charger
67101	Charging Station (<i>Requires Power Supply</i>)
67109	Automatic Calibration Station (Individual Gases) - <i>supplied with metric fittings</i>
67109Q	Automatic Calibration Station (Individual Gases)- <i>supplied with imperial fittings</i>
12444	Power Supply for Charging/Calibration Station
12988	12V Vehicle Power Supply for Charging/Calibration Station
67233	24V Reduction Box for permanent power supply from car battery for Charging/Calibration Station
67281	Wall Mount Storage Clip
67202	Pressure Tubing Connector

9.3. Spare Parts

Part No.	Description
67213	Hydrophobic Filter Bulb
67120	Protective Rubber Boot (Blue)
12737	O-Ring (use with 67142)
76038	O-Ring for Battery Compartment

9.4. Software

Part No.	Description
67160	GT Configuration & Field Calibration CD
67238	GTCAL System Package (including CD and interface)
67164	GT Data Downloading Package (including CD and interface)
67216	GT Set-up Software Package (including CD and interface)

For a comprehensive list of probes, accessories and calibration gases, contact your local distributor or alternatively, Teledyne GMI.

Appendix A. Monitor Specifications

Range	Span	Resolution	Sensor Type
Methane (CH ₄) ppm	0 - 10,000ppm	1ppm	Semiconductor
Methane (CH ₄) LEL	0 to 100% 0 to 9.9%	1% 0.1%	Catalytic Bead
Methane (CH ₄) Vol	0 to 100%	1%	Thermal Conductivity
Oxygen (O ₂)	0 to 25%	0.1%	Electrochemical
Carbon Monoxide (CO)	0 to 2000ppm	1ppm	Electrochemical
Hydrogen Sulfide (H ₂ S)	0 to 100ppm	1ppm	Electrochemical
Water Gauge	0 to 60 inH ₂ O 0 to 150mBar	0.1 in 1mBar	Differential Pressure Transducer

Other Specifications	
Dimensions (excluding probe):	290mm (11.4") x 95mm (3.7") x 43mm (1.7")
Weight:	0.78kg (1.7lbs.)
Temperature Limits:	-20°C to 50°C (-4°F to 122°F)
Humidity Limits:	0 – 95% R.H. non-condensing
Protection Rating:	Polycarbonate / ABS case protected to IP54
Sampling System:	Integral pump with pressure sensor for flow fail detection. Sample path is protected by dust and hydrophobic filters
Power Source:	Three 'C' size alkaline or rechargeable (NiMH) cells providing approximately eight hours runtime at 20°C (68°F).
Certification:	UL 913 Class I, Div 1 Groups C, D CSA Class I, Division 1, Groups C and D C22.2 N° 152 SIRA05 ATEX II 2G EEx ia d IIB T3 IECEX Ex ia d IIB T3
Datalogging:	1 week @ 1 minute interval (assuming 7hrs of operation per day)
Alarms:	High visibility LEDs on both sides of instrument 85 dB audible alarm All alarms user programmable via password protected menu

Appendix B. Technical Support

This product is designed to provide you with reliable, trouble-free service. Contact your regional technical support if you have technical questions, need support, or if you need to return a product. Details can be found at:

www.teledynegasandflamedetection.com



Note: When returning a product, contact Technical Support to obtain a Return Material Authorization (RMA) number prior to shipping.

This page is intentionally left blank.



TELEDYNE

GAS MEASUREMENT INSTRUMENTS

Everywhere you look™



AMERICAS

14880 Skinner Road
Cypress,
TX 77249, USA
Tel.: +1-713-559-9200

EMEA

Inchinnan Business Park
Renfrew, PA4, 9RG
Scotland, UK
Tel.: +44 (0) 141 812 3211

ASIA PACIFIC

750C Chai Chee Road
#03-08 Viva Business Park
Singapore 469003
Tel.: +65 84282741



www.teledynegasandflamedetection.com